

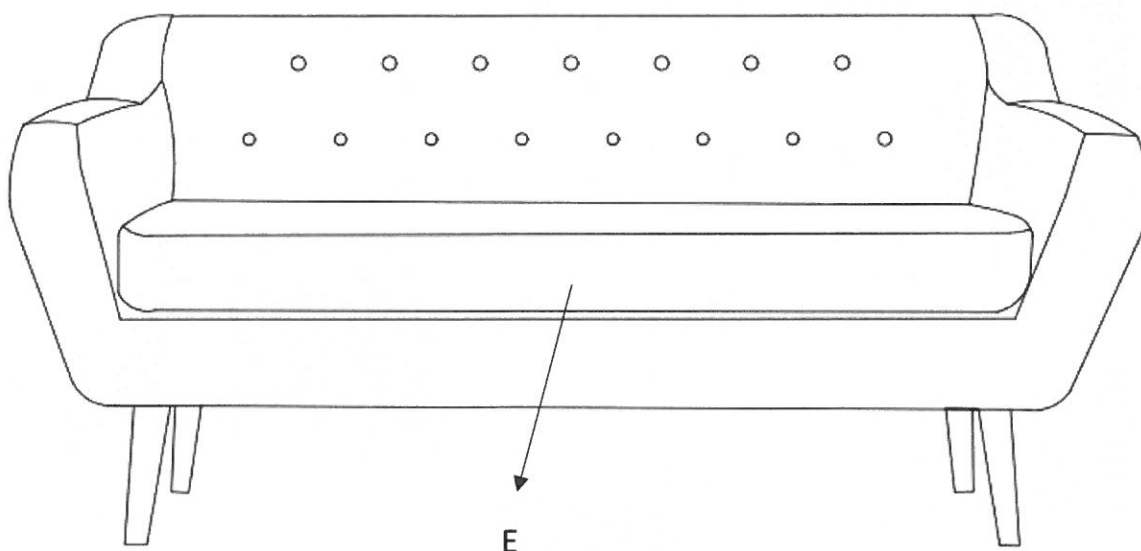

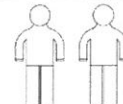



- | | | | |
|---------------------------------------|-----------------------------------|------------------------------|----------------------------------|
| D Montageanleitung | GB Assembly Instructions | CZ Montážní návod | SK Návod na montáž |
| FR Notice de montage | IT Istruzioni di montaggio | HU Szerelési útmutató | RO Instrucțiuni de montaj |
| NL Handleiding voor de montage | PL Instrukcja montażu | TR Montaj talimatı | RU Инструкция по монтажу |

RENNE 3



 A 4x	 B 4x	 C 4x
 D 4x	 E 1x	

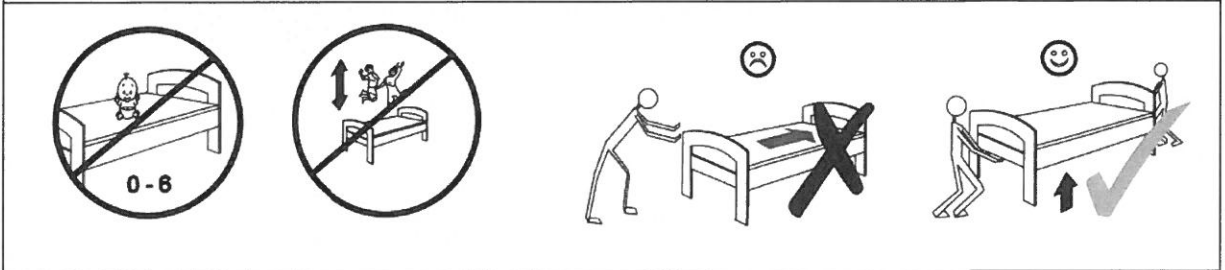
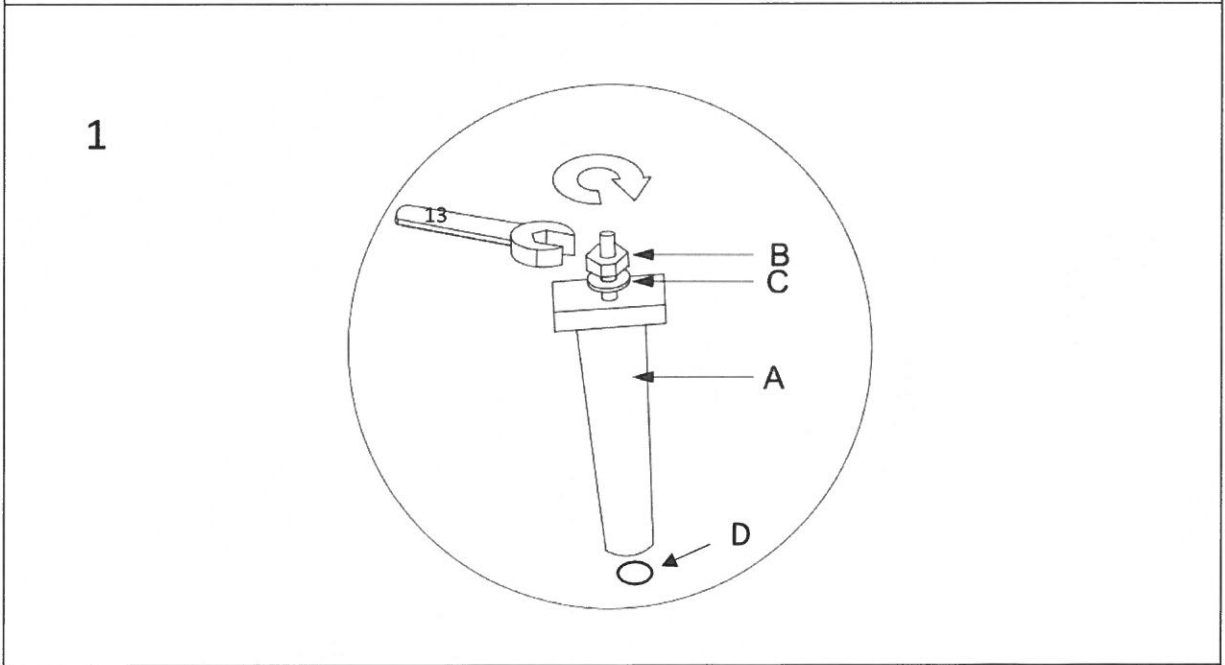
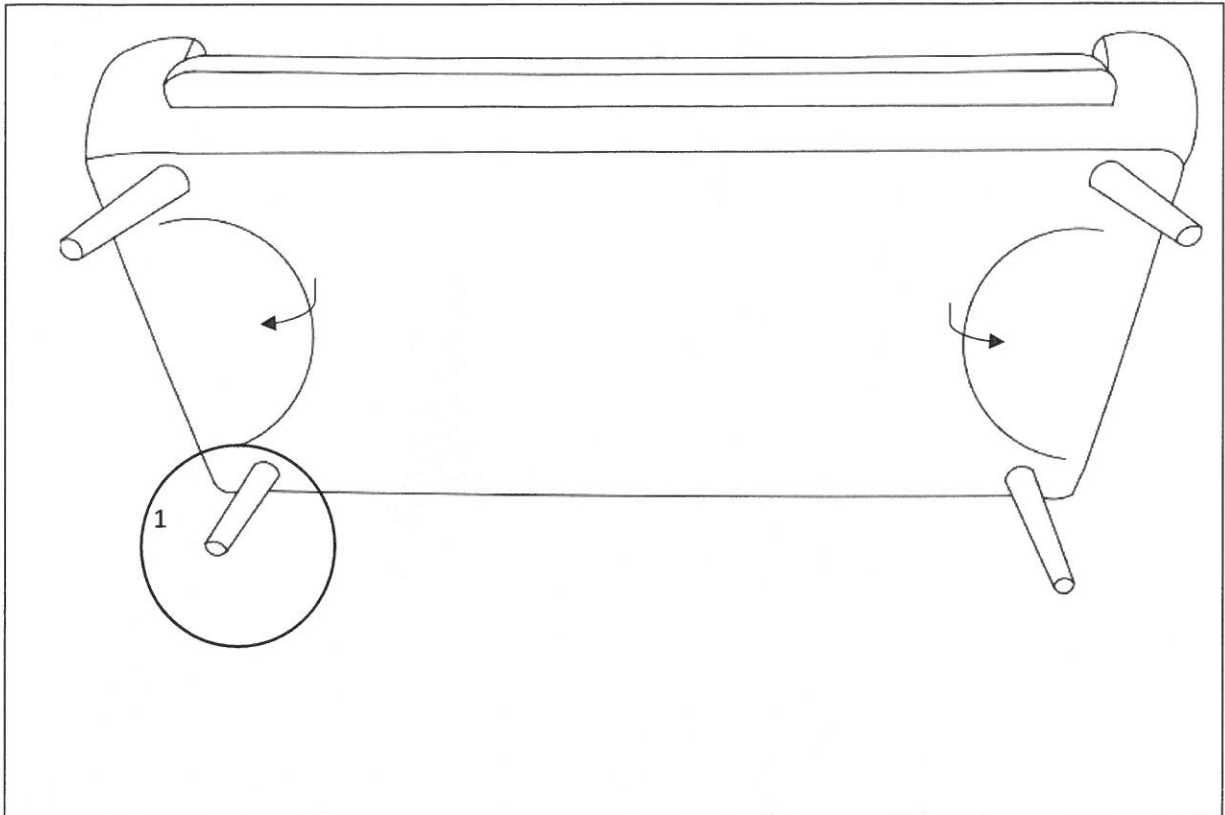

**Service • Assistenza • Dienstverlening • Serwis
Servis • Szerviz • Сервисная служба**

Name • Naam • Nazwa • Isim • Название
RENNE

Nr. • No. • Номер

Тур • Туре • Тір • Тип
3

