

# Inge 1

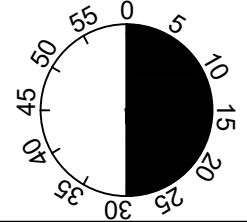
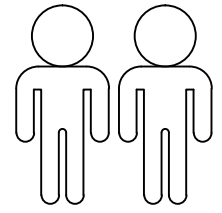
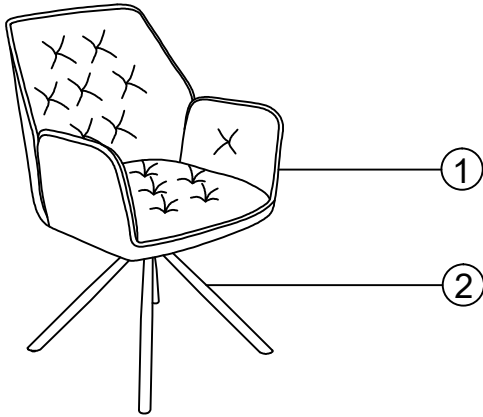

1

2

3

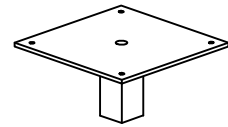
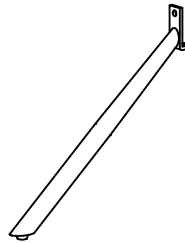
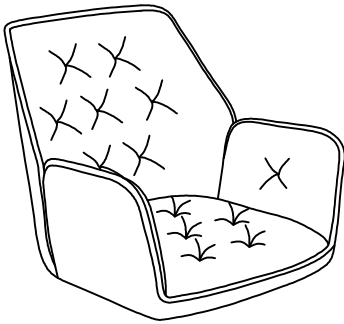

AP 60 185x185mm AR

4

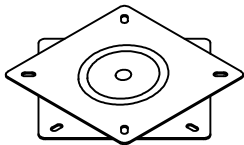





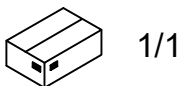

DT 180° AR 195X195mm

1	1x
2	4x
3	1x
4	1x



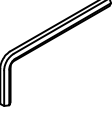
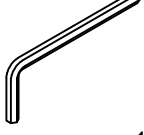





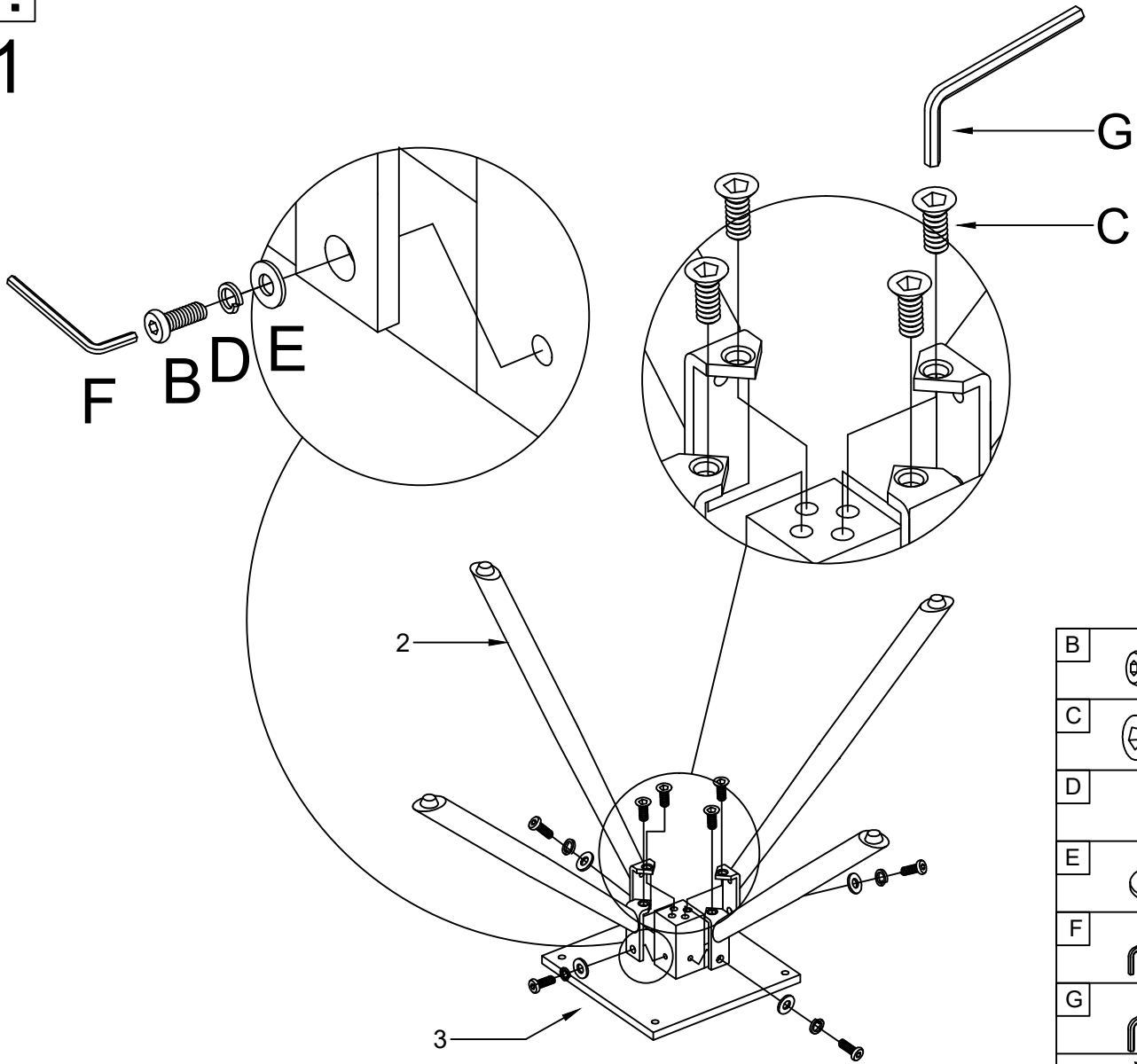

1/1

<b>A</b>	M6X10	<b>B</b>	M6X20	<b>C</b>	M8X16	<b>D</b>	M6	<b>E</b>	Ø18xØ6x1.5	<b>F</b>	4MM
											
	4x		8x		4x		4x		12x		1x
<b>G</b>	5MM	<b>H</b>	Ø17xØ6.5x4								
											
	1x		2x								

I.





1

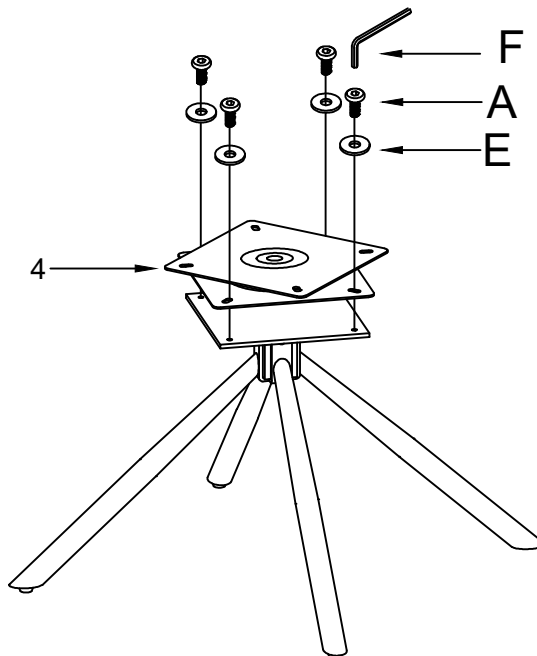

B		M6x20 4x
C		M8x16 4x
D		M6 4x
E		Ø18xØ6x1.5 4x
F		4MM 1x
G		5MM 1x
		

2



A		M6x10 4x
E		Ø18xØ6x1.5 4x
F		4MM 1x
		

II.

3

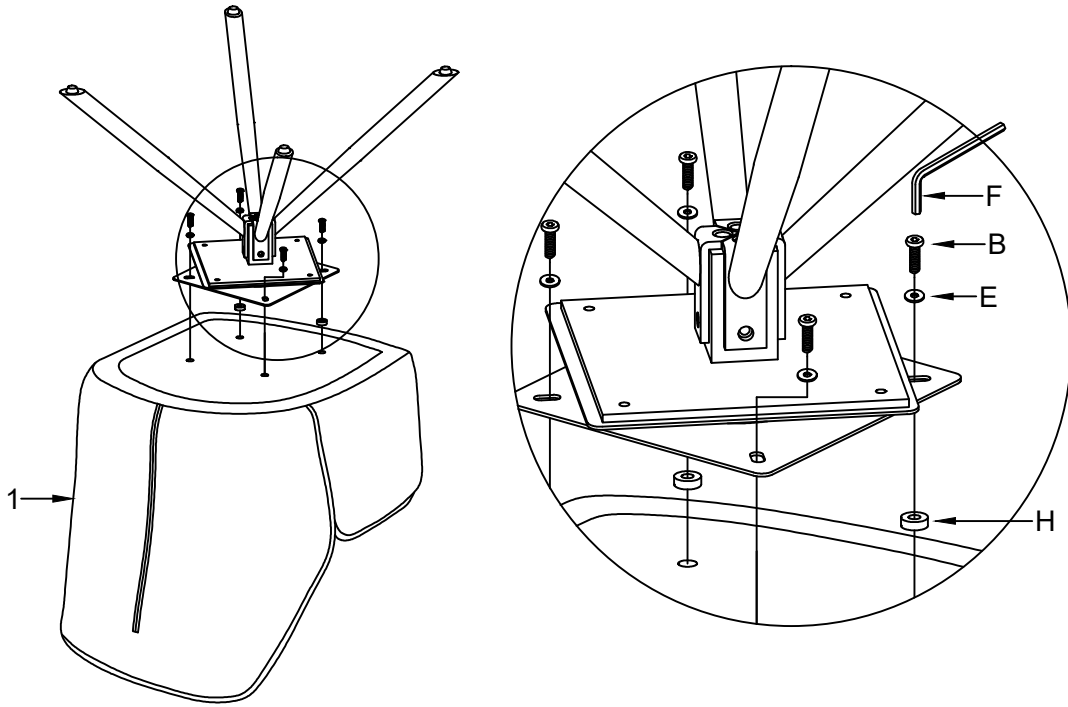

B	M6X20		4x
E	Ø18xØ6x1.5		4x
F	4MM		1x
H	Ø17xØ6.5x4		2x

4

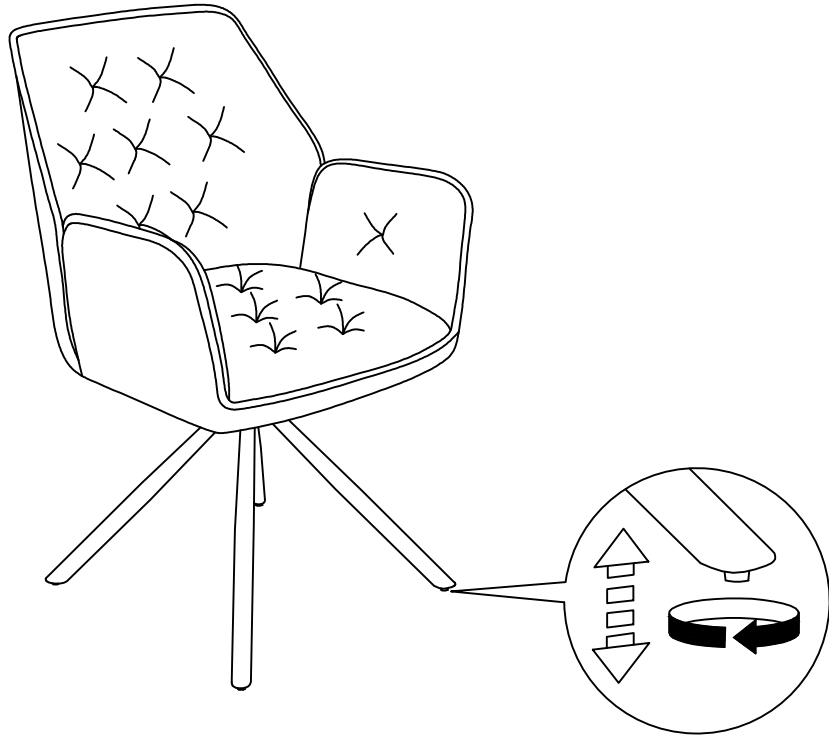

F	4MM		1x



**LE TRI  
+ FACILE**



Séparez les éléments avant de trier