

# Typ: Nr. 1519

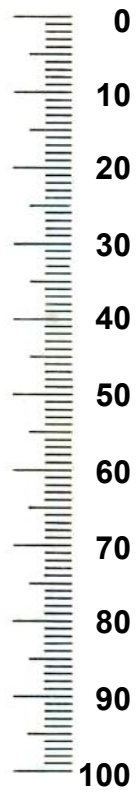
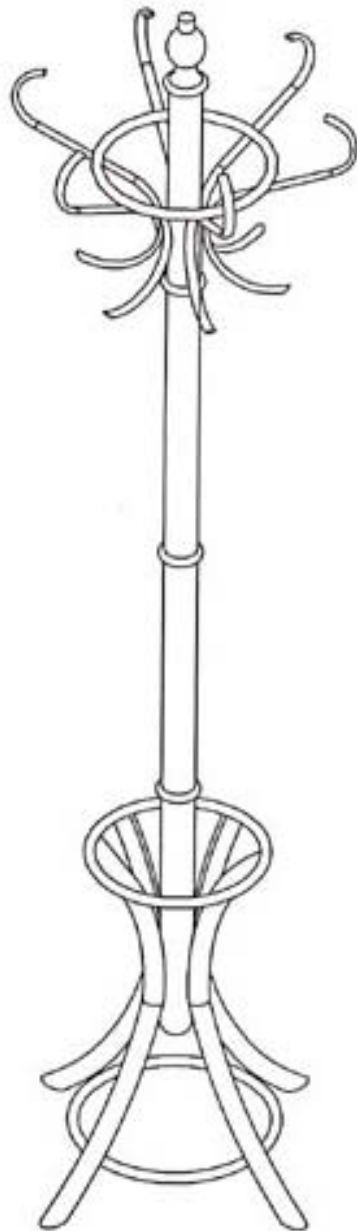

Bitte bei den Schritten 1, 2 und 4 die Schrauben zu Beginn nur leicht anziehen. Erst nach Montage aller Teile die Schrauben fest anziehen !!!

Please only slightly tighten the screws to start with steps 1, 2 and 4 . Tighten the screws after installation of all parts .

S'il vous plaît ne serrez légèrement les vis de commencer avec les étapes 1 , 2 et 4 . Serrez les vis après l'installation de toutes les parties .

Si prega solo stringere leggermente le viti di iniziare con i punti 1 , 2 e 4 . Serrare le viti dopo l'installazione di tutti i componenti.

Gelieve slechts iets draai de schroeven om te beginnen met de stappen 1 , 2 en 4 . Draai de schroeven na installatie van alle onderdelen .

Proszę tylko lekko dokręcić śruby zacząć kroki 1 , 2 i 4 . Dokręcić śruby po zamontowaniu wszystkich części .

Prosím, jen lehce dotáhněte šrouby začít s kroky 1 , 2 a 4 . Utáhněte šrouby po instalaci všech částí .

Kérjük, hogy csak kissé húzza meg a csavarokat , hogy kezdeni végre az 1 , 2 és 4 . Húzza meg a csavarokat a telepítés után az összes alkatrész .

Vă rugăm doar puțin strângeți șuruburile pentru a începe cu pașii 1 , 2 și 4 . Strângeți șuruburile după instalare din toate părțile .

Sadece biraz adım 1 , 2 ve 4 ile başlamakvidaları sıkılmalıdır. Tüm parçaların kurulumdan sonra vidalarını sıkın .

Пожалуйста, только слегка затянуть винты , чтобы начать с шагов 1, 2 и 4 . Затянуть винты после установки всех частей .

Prosím , len ľahko dotiahnite skrutky začať s krokmi 1 , 2 a 4 . Utiahnite skrutky po inštalácii všetkých častí .

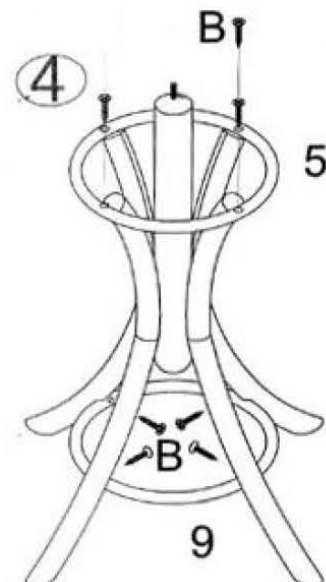
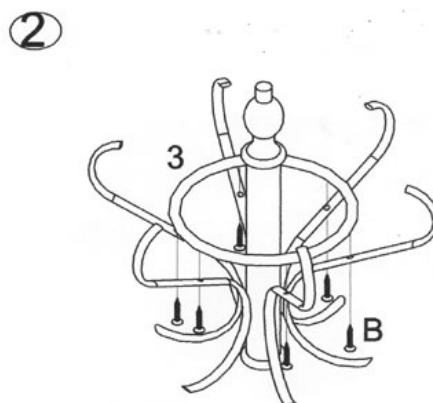
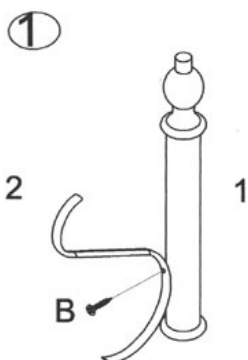

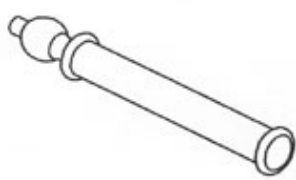

1 1X



2 6X

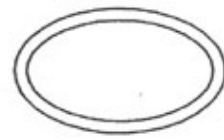

3 1X



4 1X

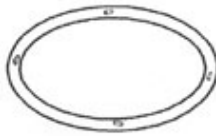

5 1X

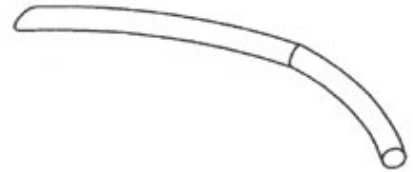

6 4X

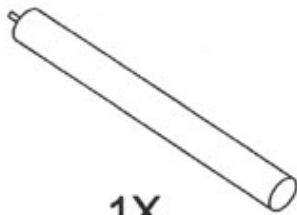

7 1X

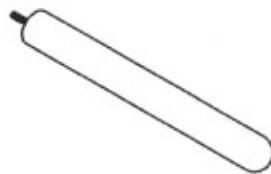

8 1X

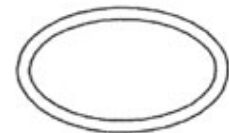

9 1X



4mmx39mm

A 8X



4mmx25mm

B 20X



C 4X

①

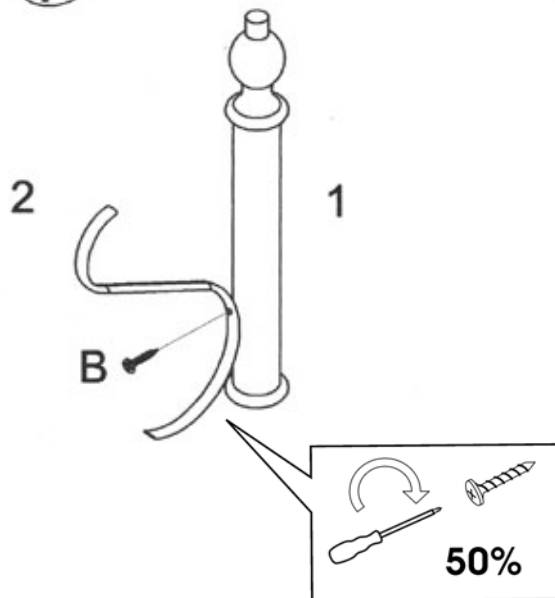

②

