

LKZ:80031

Modellname/Modelname/Nomdumodele/modellnamn
Nometmodello/Názevmodelu/Modelnaam/Imodela
NúmeroModello/Modellneve/Название модели/
Názovmodelu/imodela/Denumiremodel/
Наименование модели/Nazwa modelu

SAO PAULO

Modellnummer/Number/Numérodumodele
Numero/Номерна модели/Modello
Číslo modelu/Modellszáma/Eíslomodelu
Številka modela/Numărmodel/Brojmodela
Modellnummer/Numetmodelu

2439-301-43

Type / Tipo / Típus / Тип / Тип / Tip

301

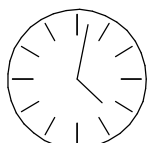
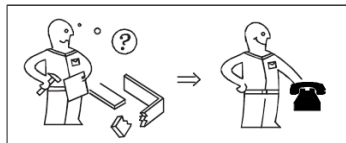
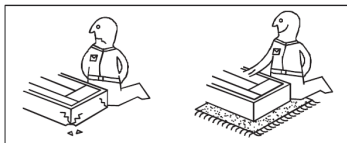
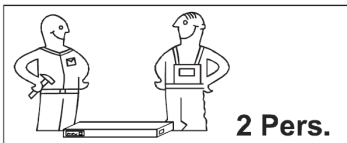

90 min

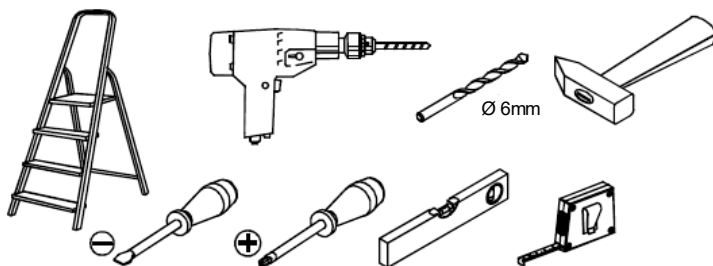
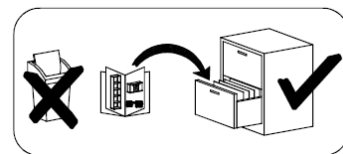
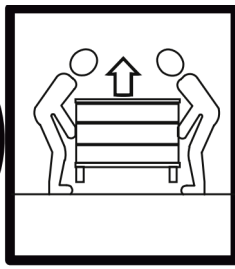
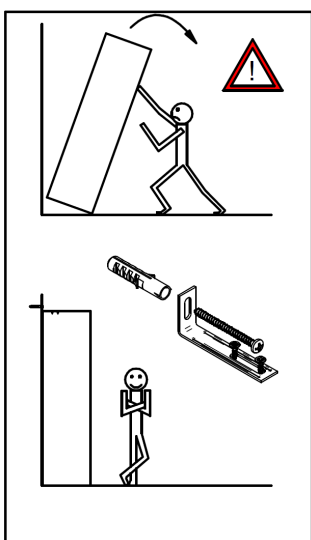
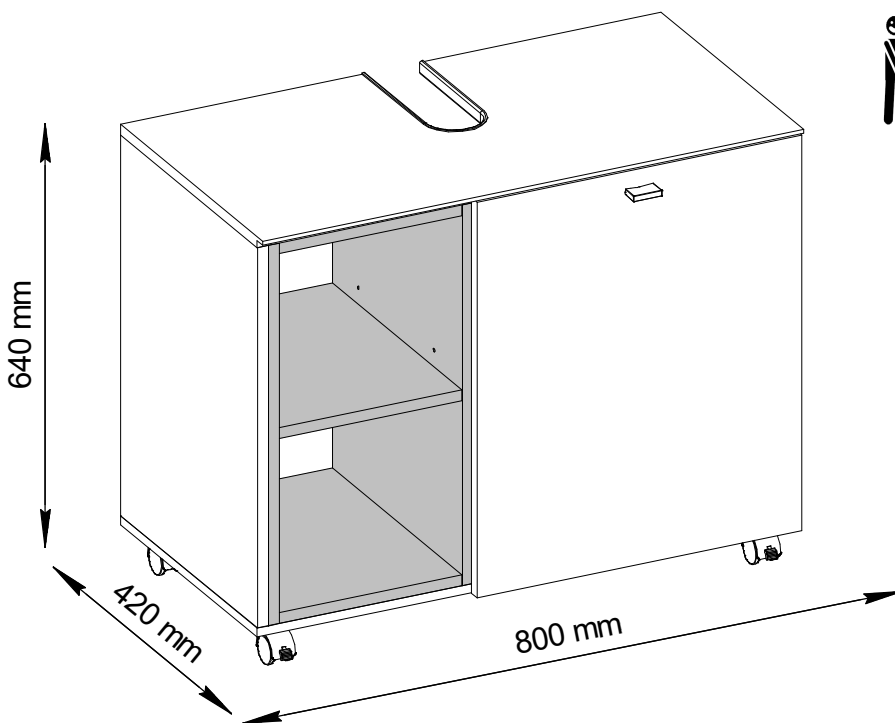

fesziehen / tighten / Затягивать /
serrer / stringete / utáhnout / vasttrekken /
zategnúti / strângere / zwiázac / zacisnaç
szorosan meghúzni / pevne dotiahnut /
trdno pritegnúti / затянуть / dra ít

eindrücken / press in / enfoncer / wcisnaç
ribattere / zatlaçit / Вжаряйте / indrukken
benyomni / stlaçit / vísniiti / tryck in
introducere prin apăsare / вдавить

ausmessen / measure / mesurer /
misurare / opmeten / izmeriti / mîara /
kíméni / izmeriti / mã surare / измерить
zméřit / Измерете / mät upp / zmierzyc

dtücken / press / presser / stisnkout /
Hatichere / vísniiti / nasinaç / drukken /
pritisniti / nacsinaç / pritisniiti / нажать /
(meg)nyomni / apăsare / tryck fast / nacsinaç

einschlagen / hammer in / bevemi / sla in
frapper au marteau / infossare / Zabit /
zarazit / Набяряйте / zabiiti / vbiç
introducere prin báteie / забить / zatlouct

Drehen - wenden / przekreçic - odwróciç /
Keren - omdraaien / Girare - Ruotare /
Okrenuti - ubnuti / Retourner - renverser /
Turn over - turn around / Otoçte - obratite /
Zavъртугу - обвъртугу / Obmíte list /

întoarçeti - rotii / Vrid runt - vänd /
прокрутить - повернуть / otoçit - obrátit
elforgatni - megfordítani

LKZ:80031

Modellname/Modelname/Nomdumodele/modellnamn
 Nomenclatura/Názevmodelu/Modelnaam/Imodela
 NuméroModello/Modellneve/Название модели/
 Názovmodelu/imodela/Denumiremodel/
 Наименование модели/Nazvamodelu

SAO PAULO

Modellnummer/Number/Numérodumodele
 Numero/Номернамодела/Modello
 Číslo modelu/Modellszáma/Eíslomodelu
 Številka modela/Numărmodel/Brojmodela
 Modelnummer/Nummermodelu

2439-301-43

Туре / Типо / Típus / Тур / Тип / Tip

301

D Unser direktservice für Beschädigte
 Sollte Ihnen ein Beschädigte fehlen, können Sie diese Servicekarte direkt an die untenstehende Adresse mailen. Wir können allerdings nur Beschädigte auf diesem Wege verschicken. Sollten Sie eine andere Beanstandung an Ihrem Möbelstück haben, so wenden Sie sich bitte direkt an Ihr Möbelhaus.

GB Our direct order service for fitting
 If a fitting part is missing, you can e-mail this service card directly to the address below. However, we can only send fitting parts in this way. If you have any other cause for complaint concerning your item of furniture, please contact your furniture store directly.

CZ Naše přímé služby pro kování
 Chybí-li vám nějaký díl z kování, můžete tuto servisní kartu odeslat e-mailem přímo na níže uvedenou adresu. Touto cestou však můžeme zoslat jen díly kování. Pokud byste reklamovali jiný díl nábytku, obraťte se přímo na svého prodejce nábytku.

F Bien étudier la notice de montage
 Si l vous manque une ferrure, veuillez envoyer directement la présente carte service à l'adresse e-mail indiquée ci-dessous. Cependant, ceci nous permet uniquement d'envoyer des ferrures. Pour tout autre type de réclamation concernant votre meuble, veuillez contacter directement votre magasin d'ameublement.

I Il nostro servizio diretto per l'ordine della ferramenta
 Qualora Vi dovesse mancare un pezzo di fissaggio, allora Vi preghiamo di inviare questa carta di servizio immediatamente all'indirizzo sottostante. Possiamo inviare i pezzi di fissaggio solamente per mezzo di questo procedimento. Qualora dovete avere qualche altra reclamazione in merito al mobile, allora Vi preghiamo di rivolgervi direttamente al Vostro Negozio di mobili.

BG Нашата директна услуга за обков
 Ако липсват части от комплекта, потърпете настоящата сервисна карта и ни я изпратете на e-mail адреса, посочен по-долу. По този начин можем да доставим само липсващи елементи от обкова. Ако установите други дефекти по мебелите, Ви съветваме да се обърнете към мебелната къща/магазин, от който сте закупили стоката.

NL Onze directservice voor losse onderdelen
 Wanneer er een onderdeel ontbreekt, kunt u deze servicekaart direct aan onderstaand e-mailadres sturen. Wij kunnen langs deze weg echter alleen beslagdelen versturen. Mocht u een ander probleem aan uw meubel hebben, verzoeken wij u contact op te nemen met uw meubeldealer.

PL Nasz bezpośredni serwis części montażowych
 Jeżeli brakuje części koniecznych do montażu, prosimy o przesłanie nam niniejszej karty serwisowej na niżej podany adres e-mailowy. W ten sposób możemy przesyłać Parlistwu tylko brakujące części. W przypadku innych reklamacji dotyczących mebla, prosimy zgłosić się do salonu meblowego, w którym został dokonany zakup.

HR Servis za okove
 U slučaju da nedostaje neki od dijelova molimo vas da na dolje navedenu mail adresu pošaljete ovaj servisni obrazac. Na ovaj način mogu se dostaviti samo okovi. U slučaju da imate dodatne prigovore vezane uz komad namještaja molimo vas da se obratite izravno trgovini namještaja gdje je isti kupljen.

HU Direktszolgáltatunk vasalatoik esetén
 Ha hiányzik egy vasalat, ezt a kártyát közvetlenül elküldheti az alábbi látható címre. Azonban csak vasalatoikat tudunk így küldeni. Amennyiben másfajta reklamáció áll fenn bútorárbajt illetően, forduljon közvetlenül a bútorházhöz.

SK Naše priamy servis pre časti kovania
 Ak by Vám chýbala nejaká časť kovania, môžete poslať túto servisnú kartu pošlou e-mailom na nižšie uvedenu adresu. Diely kovania vieme poslať iba týmto spôsobom. Ak by ste mali inú reklamáciu ohľadom Vašho nábytku, obraťte sa priamo na Vašu predajňu nábytku.

SLO Naše direktne uslužne storitve za okove
 Če vam manjka kakšno okovje, lahko to servisno kartico pošljete po e-pošti direktno na spodnji naslov. Po tej poti vam lahko pošljemo samo okovje. Če želite reklamirati kakšen drug del pohištva, se obrnite neposredno na vašo trgovino pohištva.

RO Service-ul nostru direct pentru feronerie
 In cazul in care va lipsesc o piesa de feronerie puteti sa trimiteți direct acest card de service prin e-mail la adresa de mai jos. Noi nu putem expedia piese de feronerie decât pe această cale. Dacă aveți o altă reclamație referitoare la piesa de mobilier, atunci vă rugăm să vă adresați direct la magazinul dvs. de mobilier.

RUS Наш прямой сервис для поставок фурнитуры
 Если оказалось, что Вам не хватает того или иного элемента фурнитуры, Вы можете отправить сервисную карту по факсу непосредственно на нижеприведенный адрес электронной почты. Однако, таким образом мы можем переслать лишь фурнитуру. Если же у Вас возникнут иные претензии относительно приобретенного мебели, пожалуйста, обращайтесь непосредственно в организацию, осуществляющую продажу.

S Vår direktservice för beslagsdelar
 Om du saknar en beslagsdel kan du skicka detta servicekort direkt till e-postadressen som anges nedan. Tänk på att detta är den enda möjligheten att skicka beslagsdelar till dig. Om du vill reklamera din möbel av en annan anledning måste du kontakta ditt möbelhus direkt.

ES Nuestro servicio directo para accesorios
 Si le falta algún accesorio, puede enviar esta de servicio directamente a la siguiente dirección. No obstante, por este método solo podemos enviar accesorios. Si tiene alguna otra objeción sobre su mueble, consulte directamente con su mueblería.

TR Donatılar için doğrudan servisimiz
 Bir donatınız eksikse bu servise kartını doğrudan aşağıda bulunan adrese doğrudan mail yazabilirsiniz. Sadece bu yolla donatılar gönderilebilir. Mobilyanızda başka şikayetleriniz varsa lütfen doğrudan mobilya satıcınıza danışın.

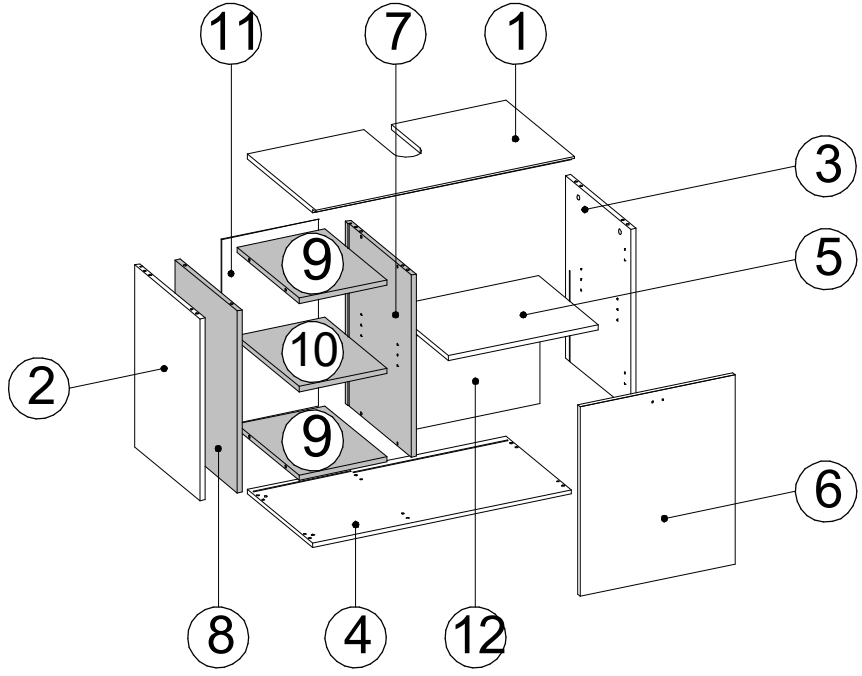

Nr.	Abmessung (mm)		Anzahl	Colli
1	800	420	16	x1 1/1
2	553	403	16	x1 1/1
3	553	403	16	x1 1/1
4	800	403	16	x1 1/1
5	464	370	16	x1 1/1
6	575	480	16	x1 1/1

7	553	403	16	x1	1/1
8	553	383	16	x1	1/1
9	382.5	271	16	x2	1/1
10	380	271	16	x1	1/1
11	567	301	3	x1	1/1
12	478	283	3	x1	1/1
B1				x1	1/1

Grund der Beanstandung / Cause for complaint:

Möbelhaus / Furniture store:

Kunde / Customer: **Telefon / Telephone:**

PLZ / Postcode: **Ort / City:**

Str. + Nr. / Street address:

@E-Mail:

LKZ:80031

Modelname/Modelname/Nomdumodele/modellnamn
Nometmodello/Názevmodelu/Modelnaam/Imemodela
NúmeroModello/Modellneve/Название модели/
Názovmodelu/imemodela/Denumiremodel/
Наименование модели/Nazwa modelu

SAO PAULO

Modellnummer/Number/Numérodumodele
Numero/Номерна модели/Modello
Číslo modelu/Modellszáma/Eíslomodelu
Številka modela/Numărmodel/Brojmodela
Modellnummer/Numetmodelu

2439-301-43

Typ / Tipo / Típus / Тип / Тип / Tip

301

B1

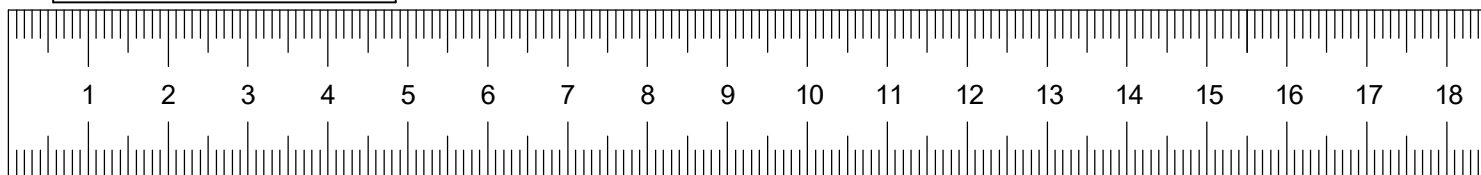
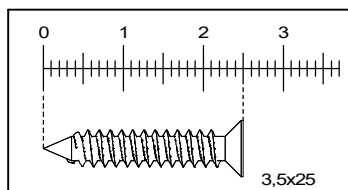
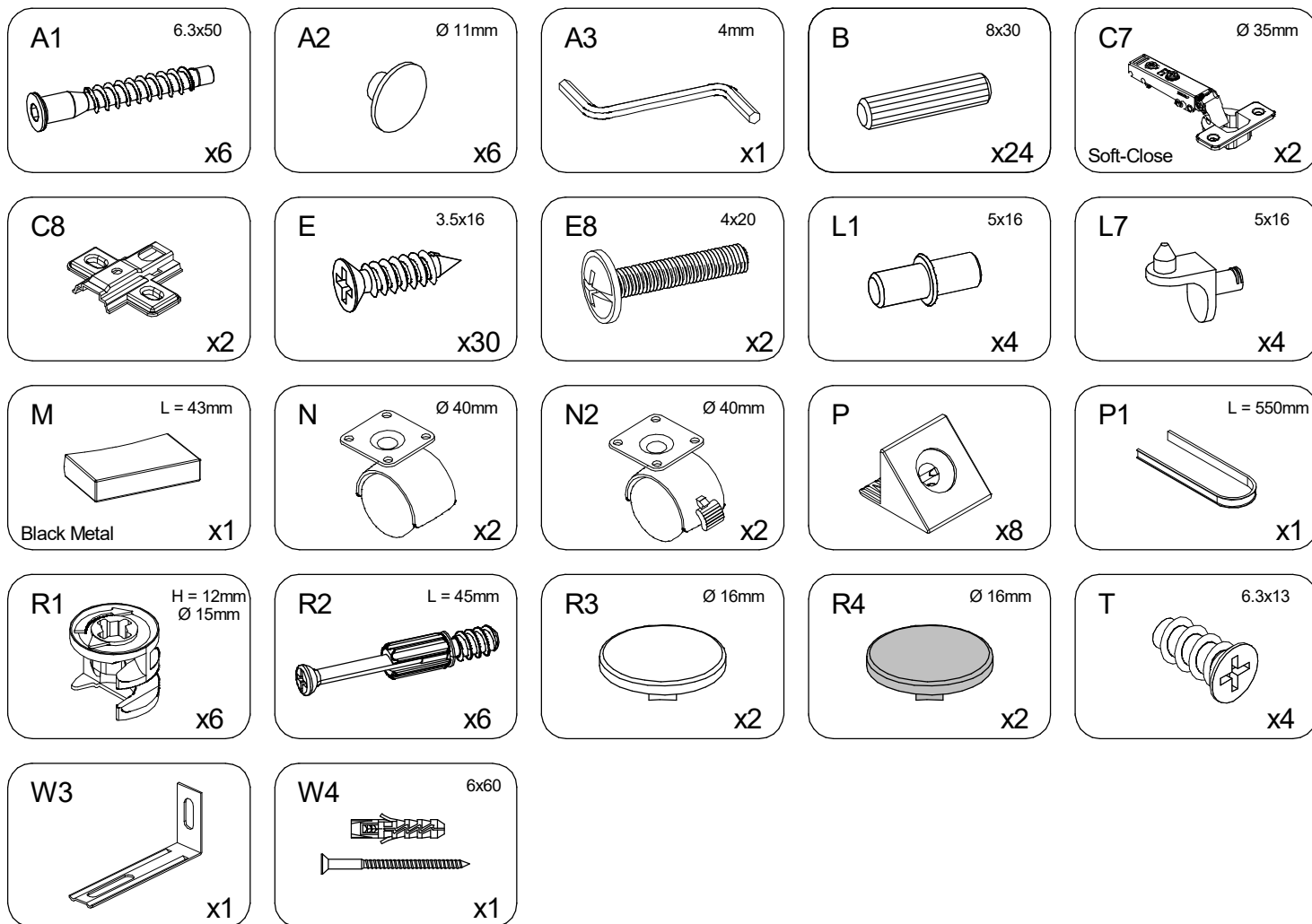

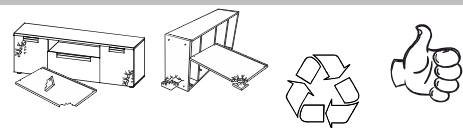
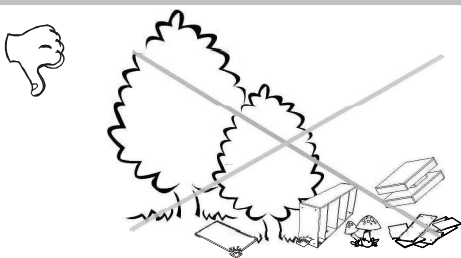
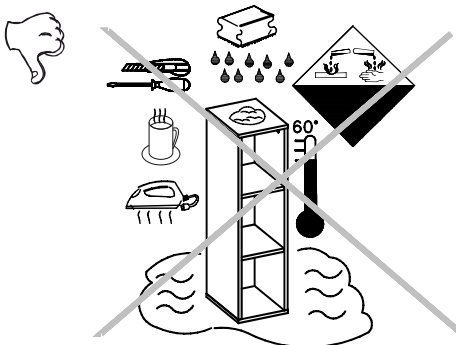
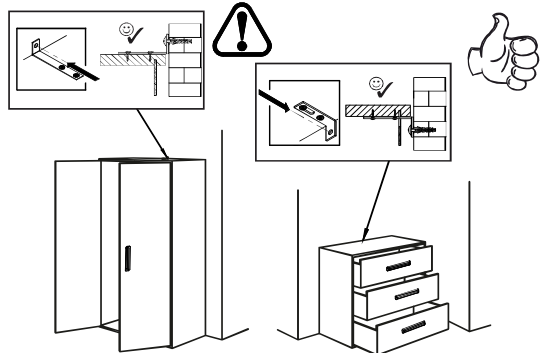
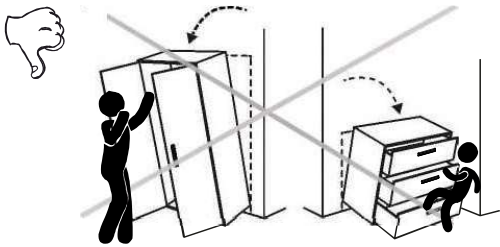
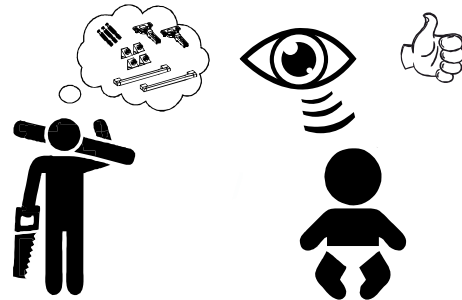
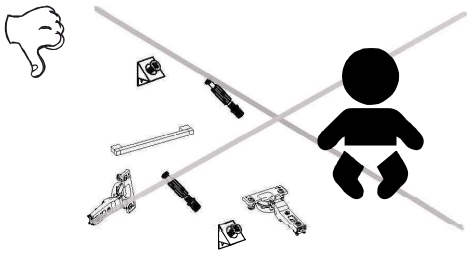
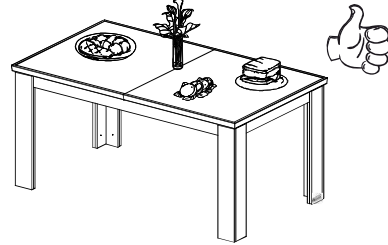
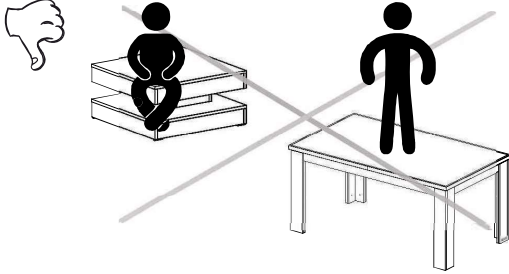
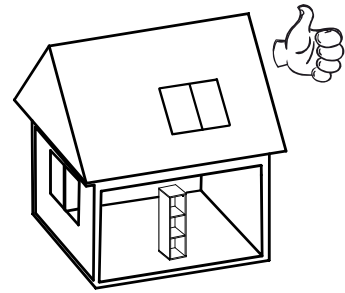
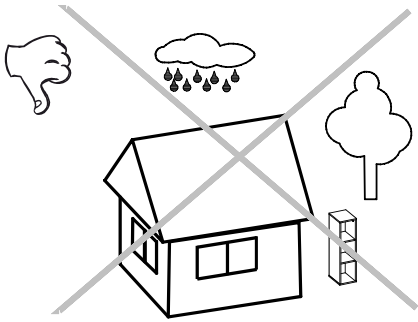

<https://quefairedemesdechets.fr>



1

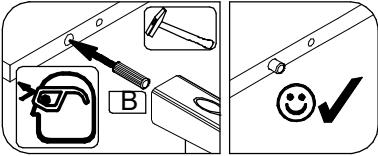
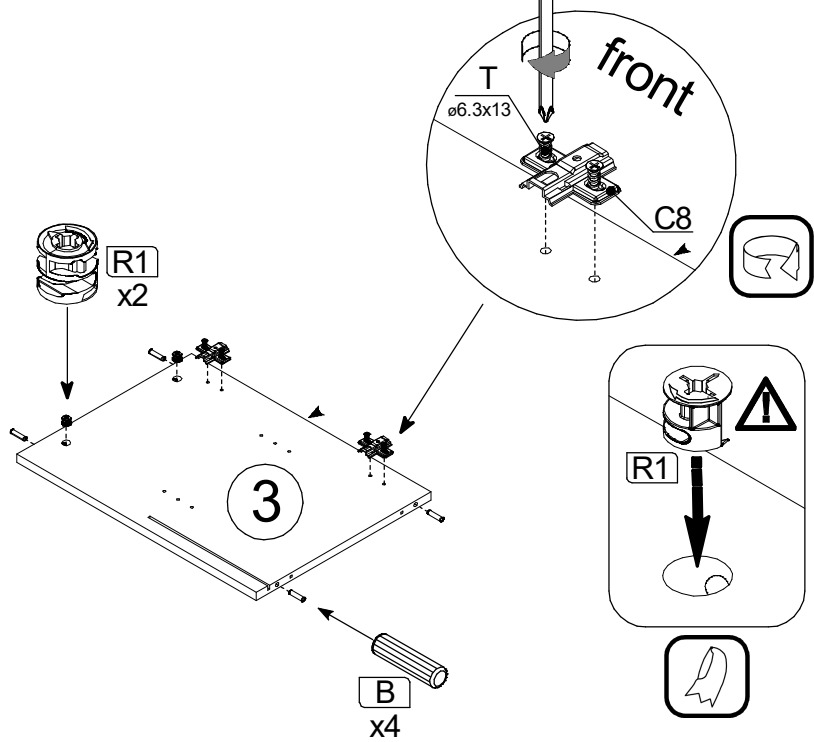
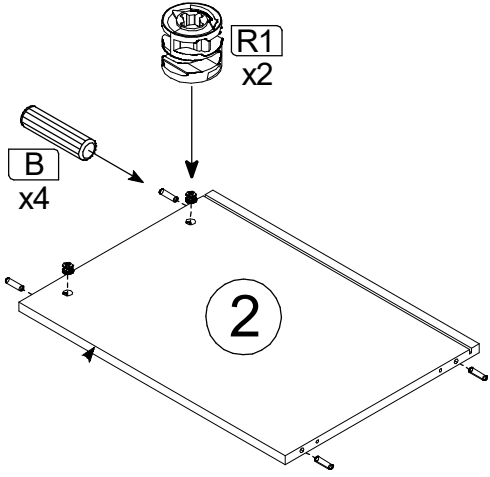
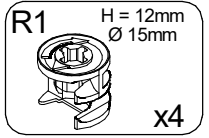
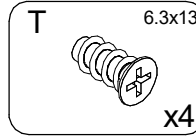
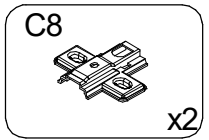
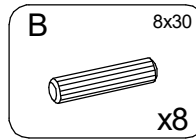
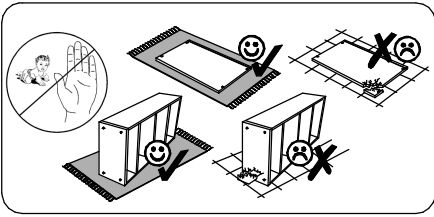

2

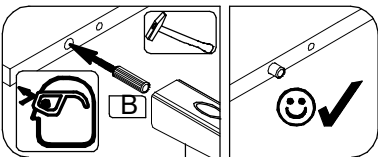
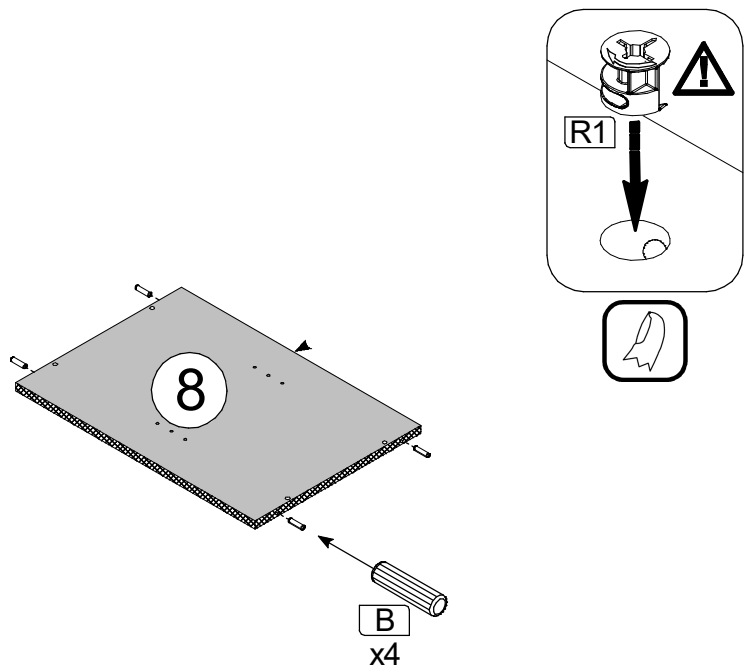
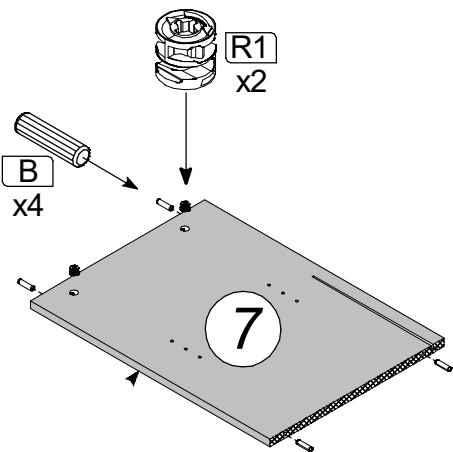
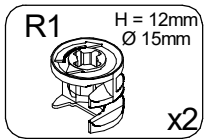
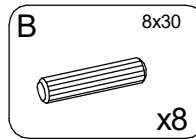
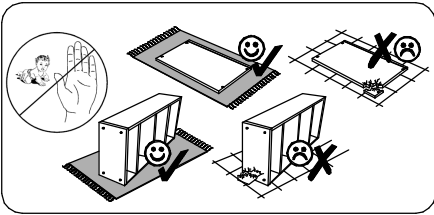

3

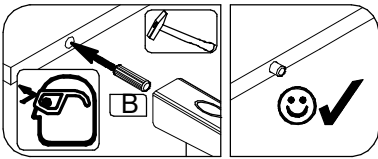
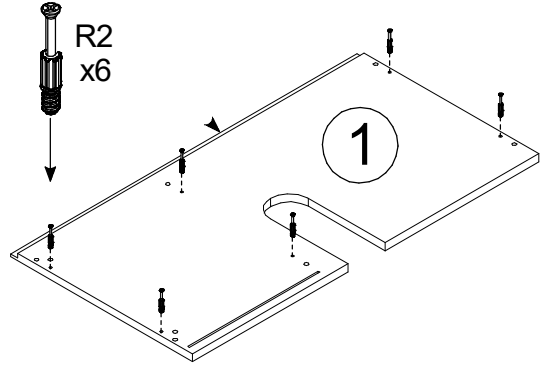
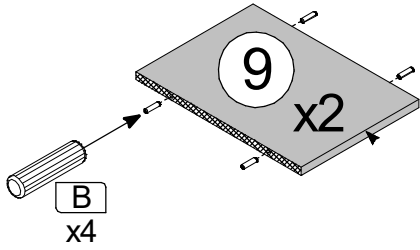
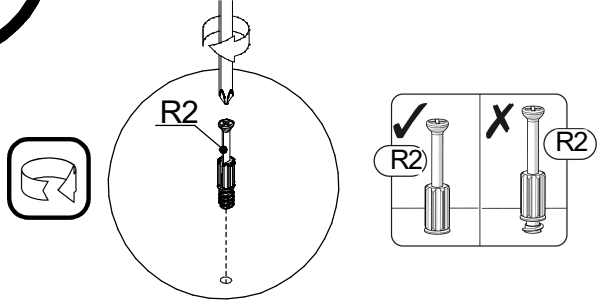
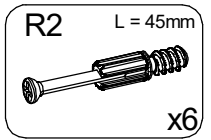
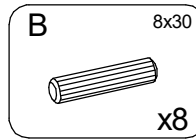
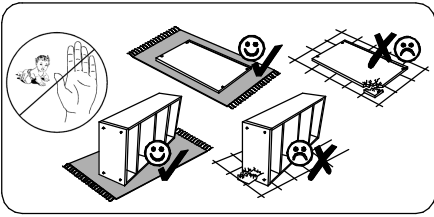

4

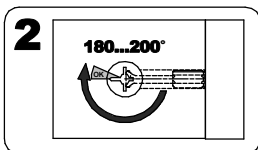
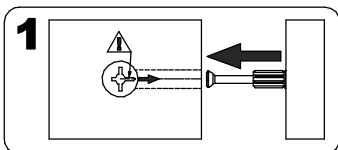
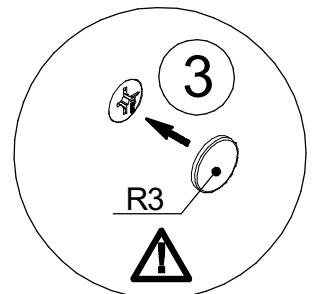
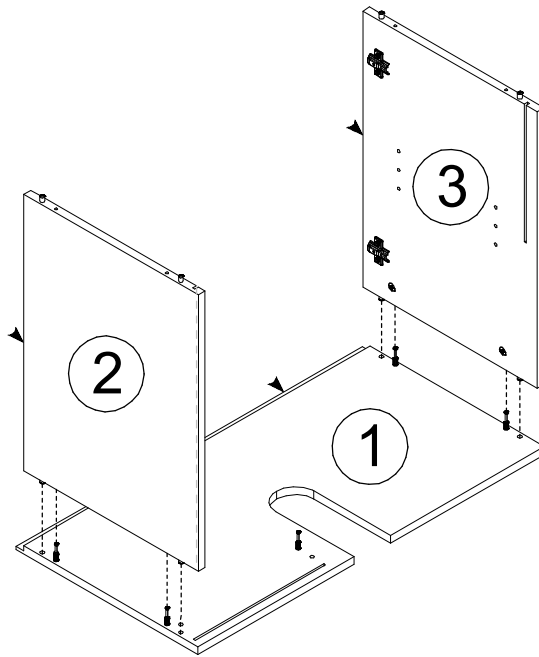
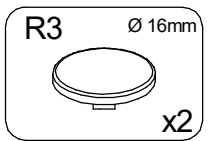

5

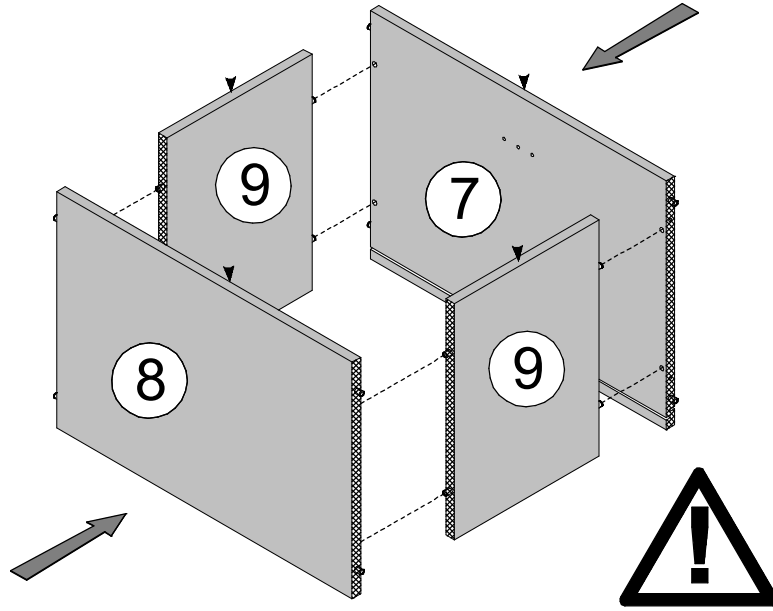
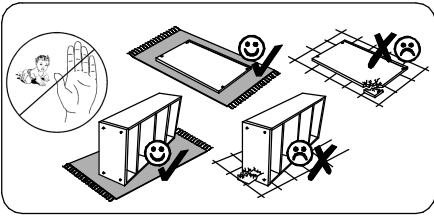

6

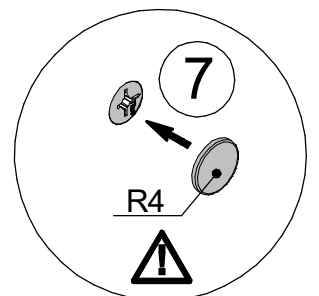
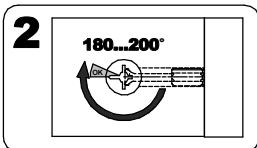
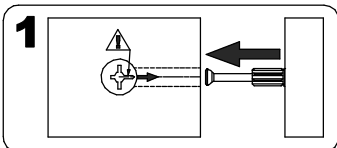
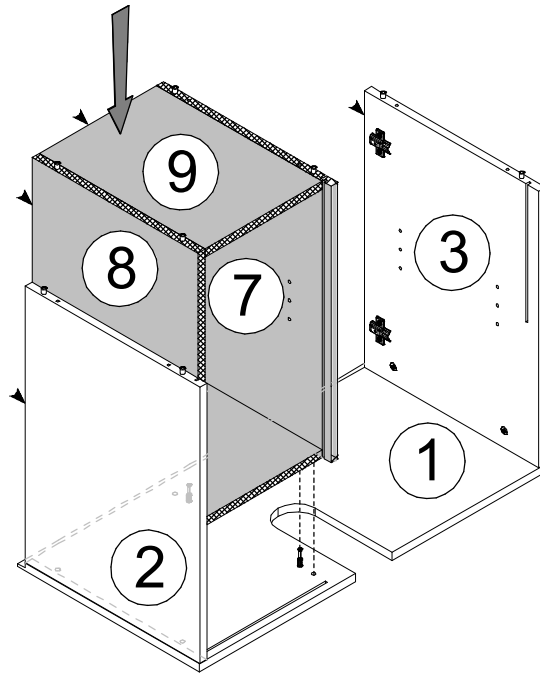
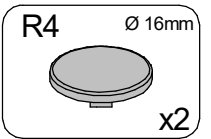

7

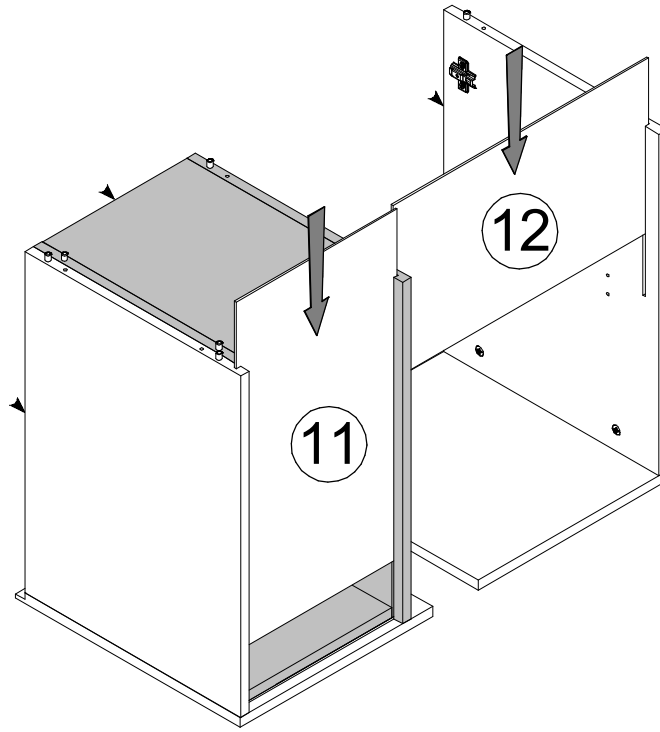
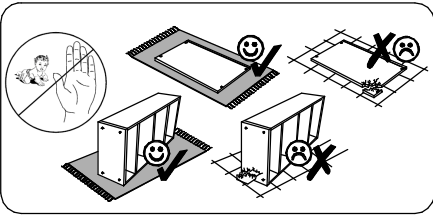

8

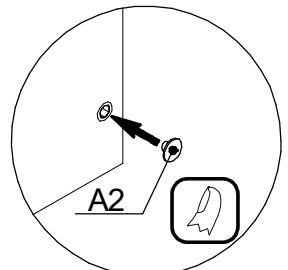
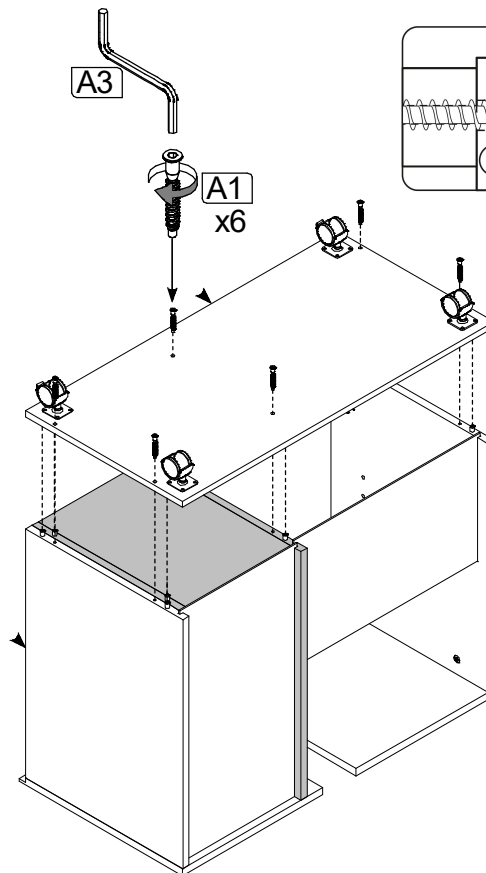
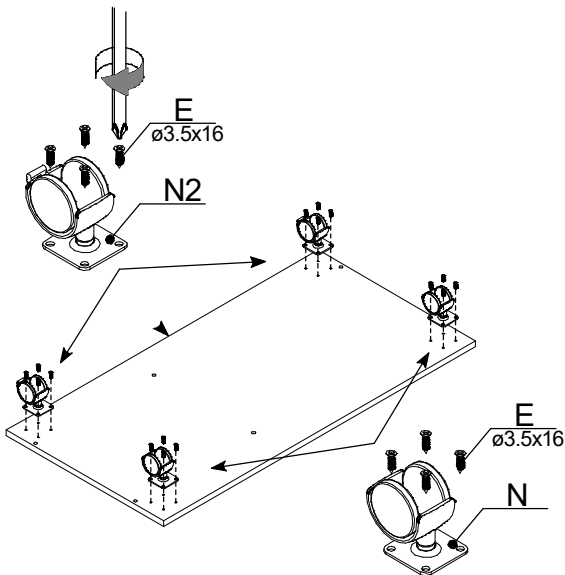
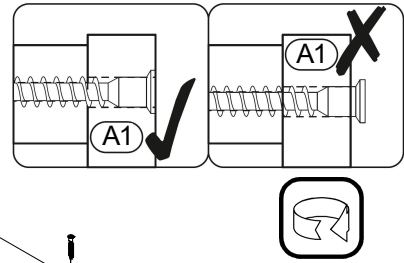
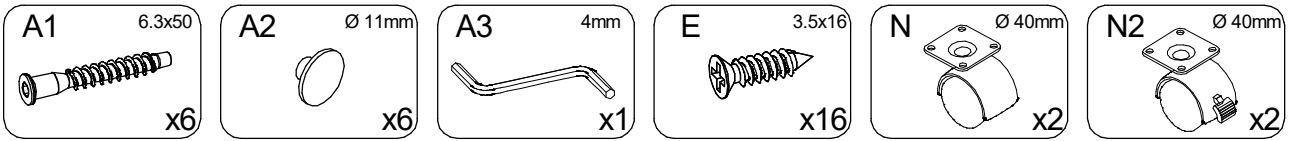

9

