



D Montageanleitung

F Notice de montage

NL Handleiding voor de montage

CZ Monzázní návod

HU Szereelési útmutató

TR Montaj talimatı

GB Assembly instructions

I Istruzione di montaggio

PL Instrukcja montaży

SK Návod na montáž

RO Instrucțiuni de montaj

RU ИНСТРУКЦИЯ ПО МОНТАЖУ

Art. Nr.

3721-62

3729-62

90 x 190 cm

120 x 220 cm

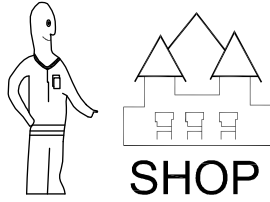
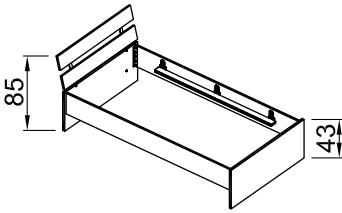

Art. Nr. 3721-62

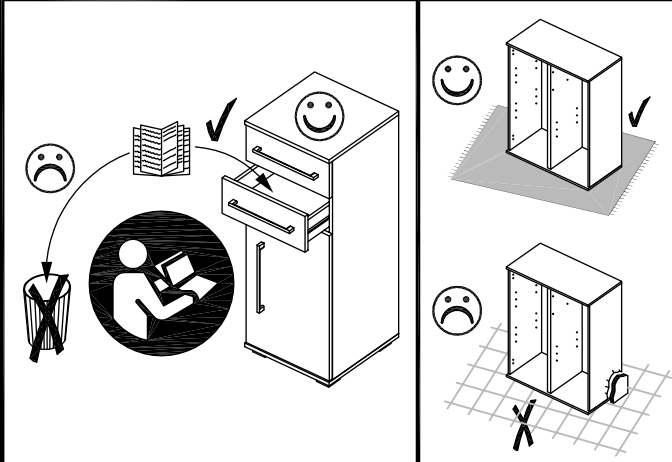
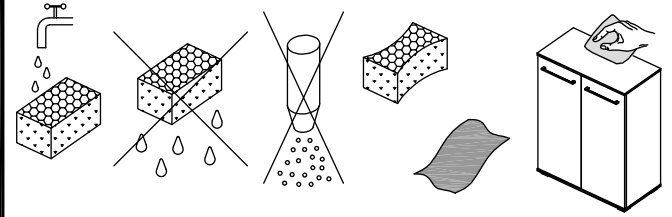
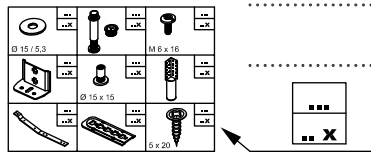
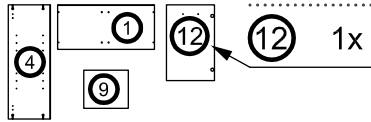

	99
	4x
Ø 18 / 6,4	
	123
	6x
	124
	12x
4 x 17	
	335
	4x
M 6 x 16	
	563
	4x
M 6 x 20	
	564
	2x
	566
	8x
Ø 15 x 15	
	632
	28x
5 x 17	

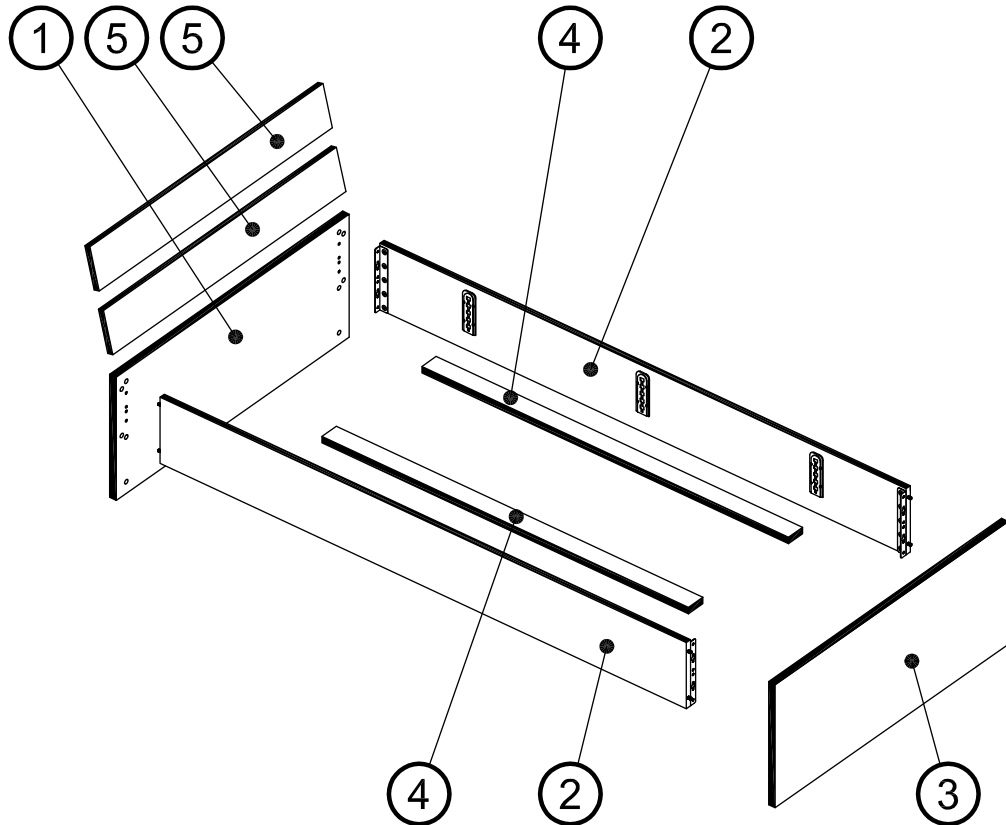

1

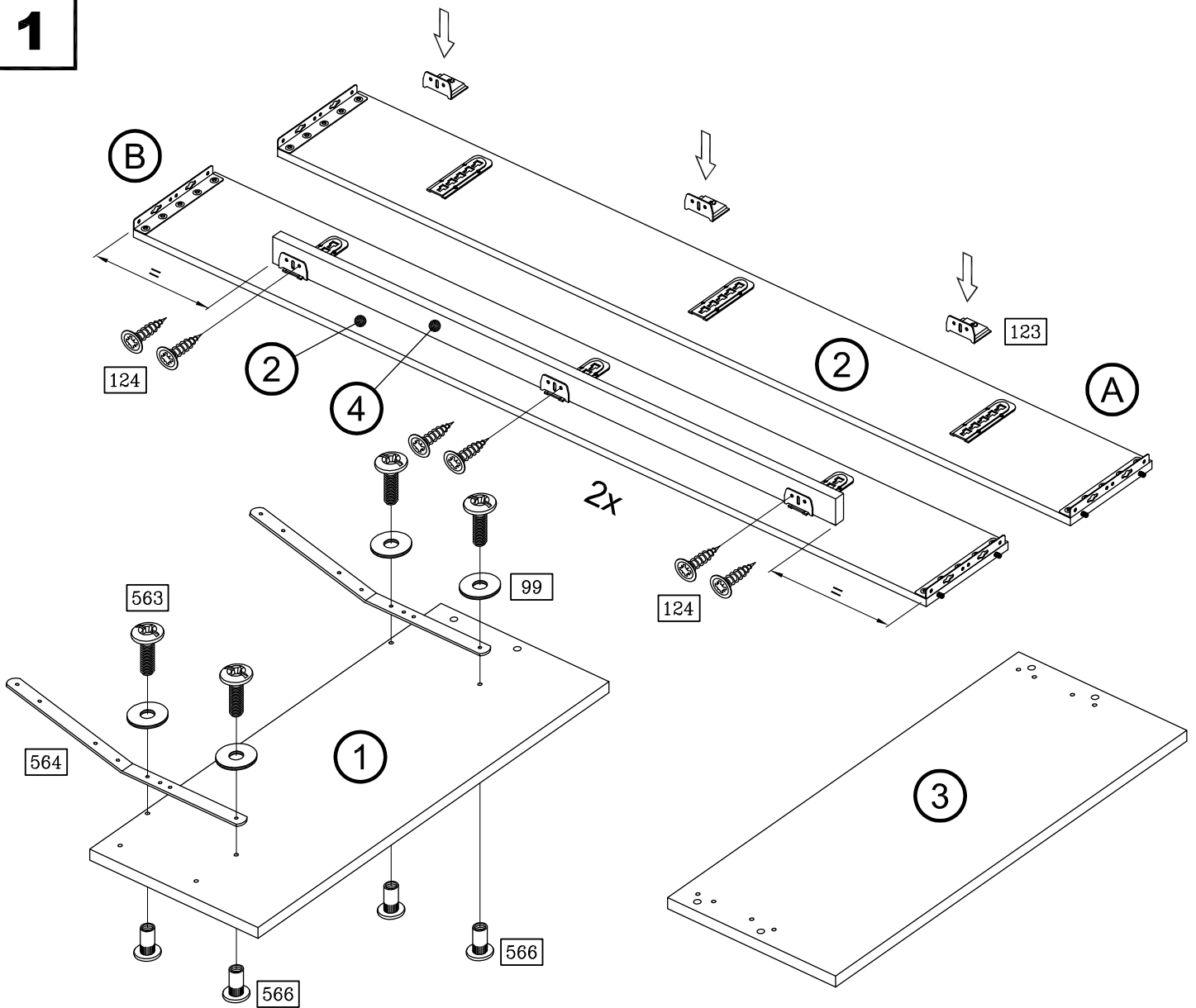

2

