

**D** Montageanleitung

**GB** Assembly instructions

**CZ** Montážní návod

**SK** Návod na montáž

**FR** Notice de montage

**IT** Istruzioni di montaggio

**HU** Szerelési útmutató

**RO** Instrucțiuni de montaj

**NL** Handleiding voor de montage

**PL** Instrukcja montażu

**TR** Montaj talimatı

**RU** Инструкция по монтажу

# SKIDI CORNER RIGHT

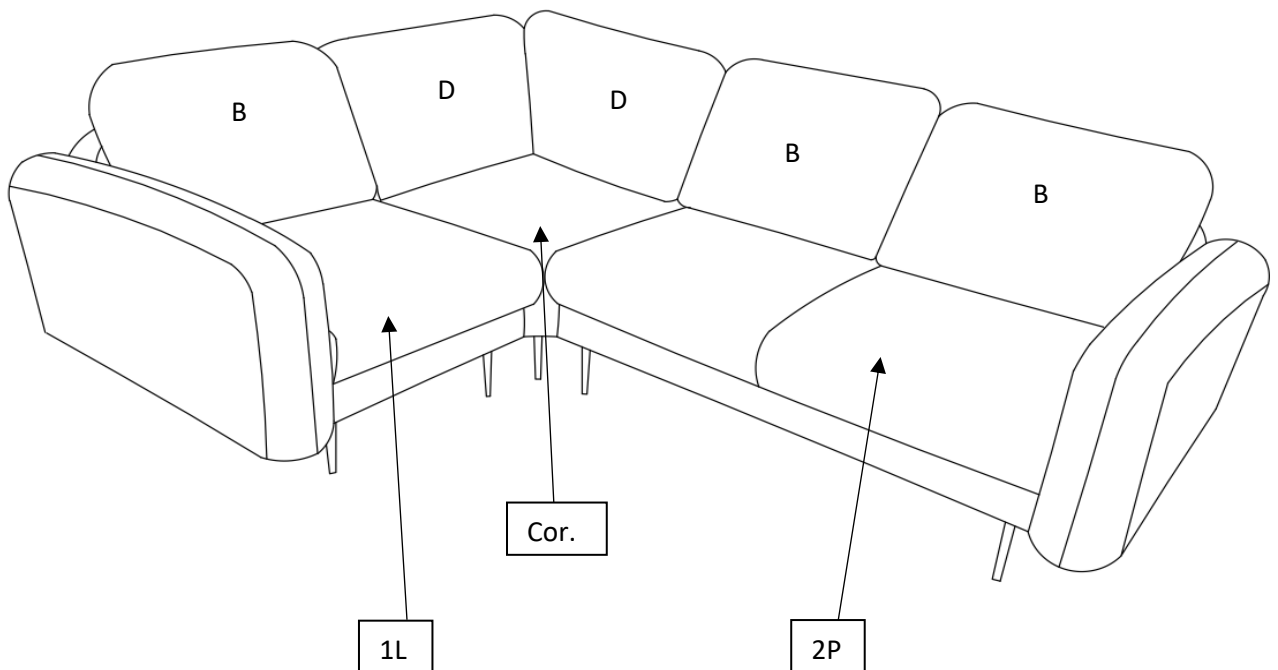
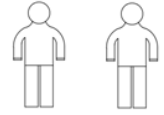

GR 1  
50x85x92  
1L x1  
B x1  
A x4  
C x4

GR 2  
50x95x95  
Cor. x1  
D x2  
A x4  
C x4

GR 3  
50x145x92  
2P x1  
B x2  
A x4  
C x4

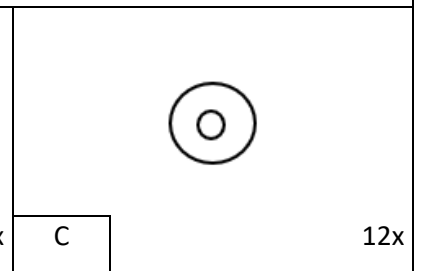
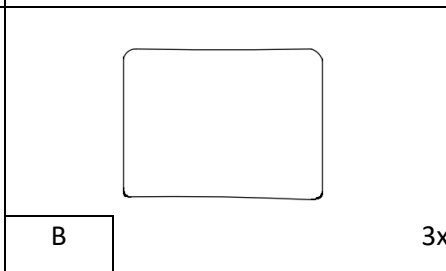
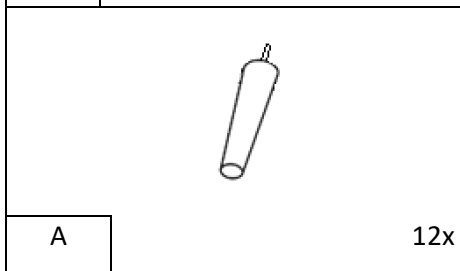
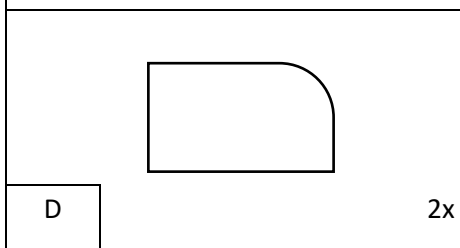

2P

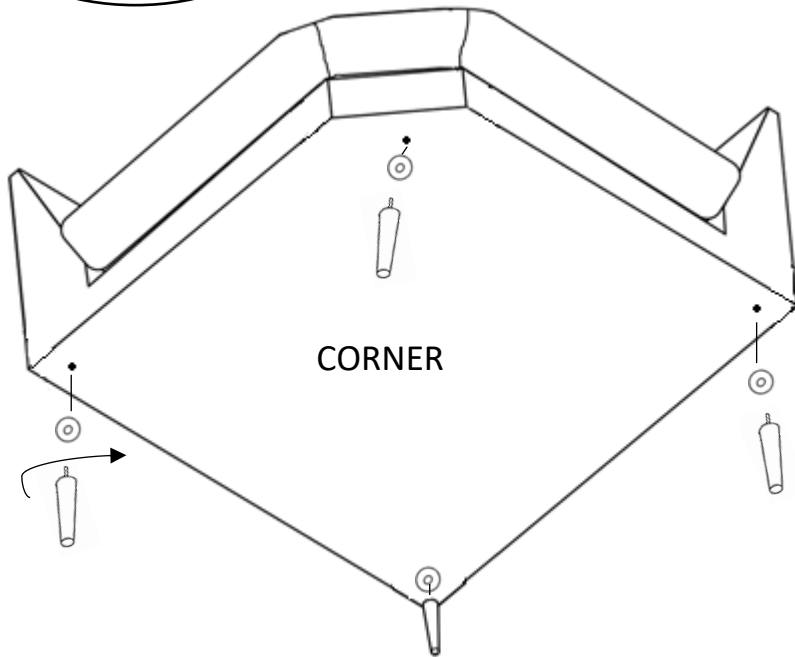
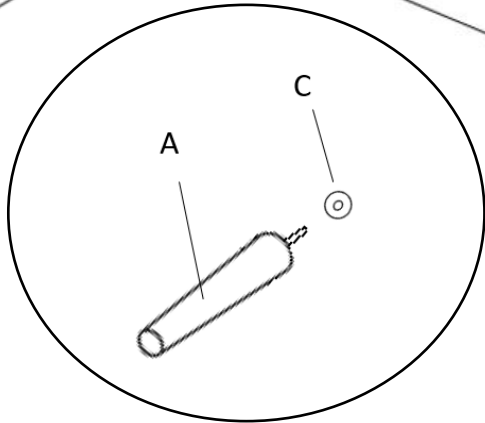
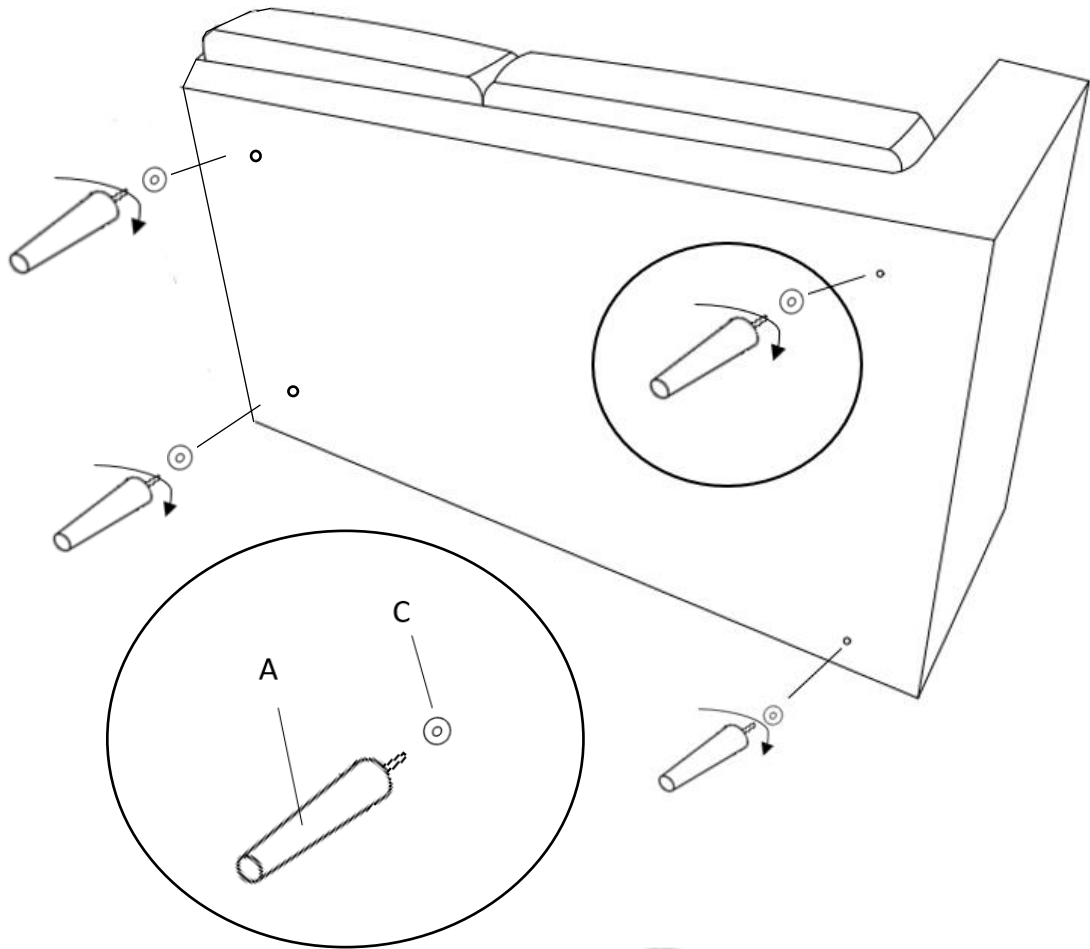

1L

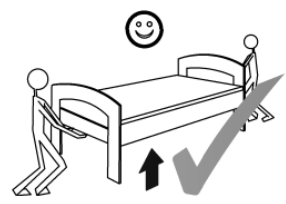
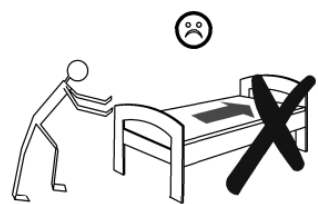
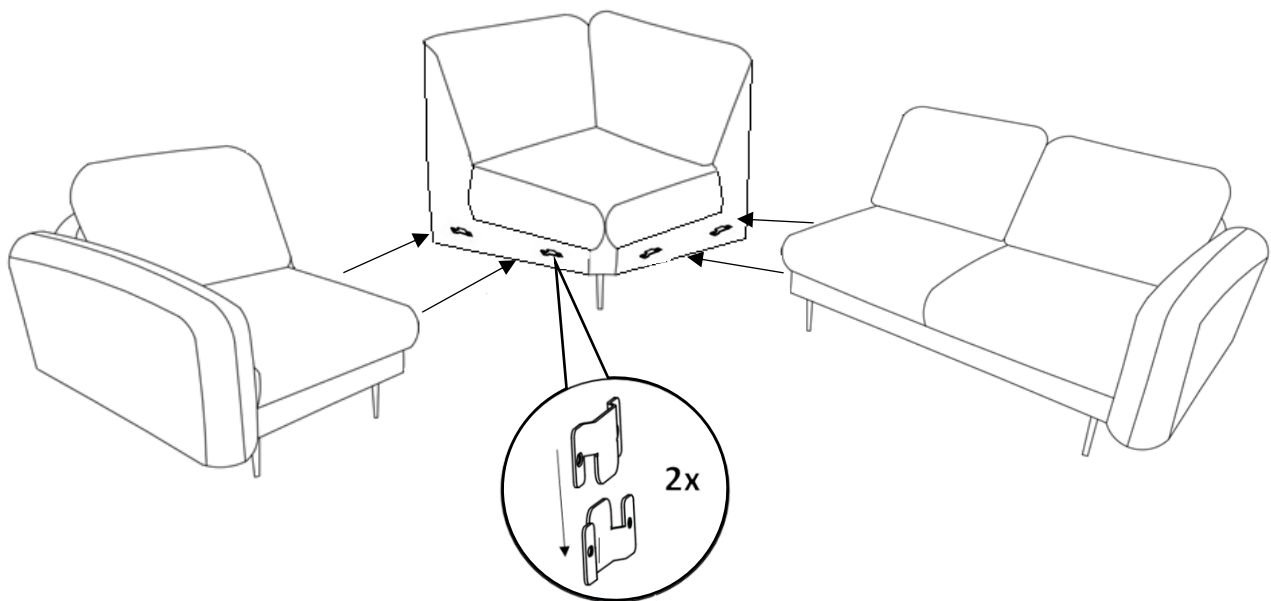
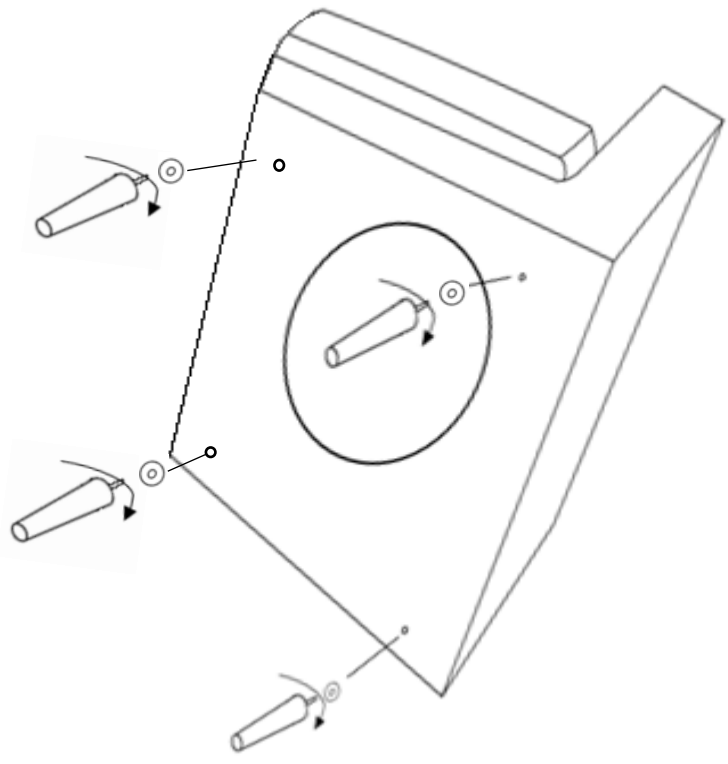

**Service • Assistenza • Dienstverlening • Serwis  
Servis • Szerviz • Сервисная служба**

Name • Naam • Nazwa • İsim • Название

**SKIDI**

Nr. • No. • Номер

Typ • Type • Тір • Тип

**CORNER RIGHT**

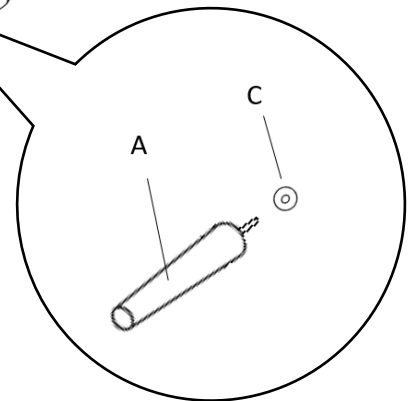
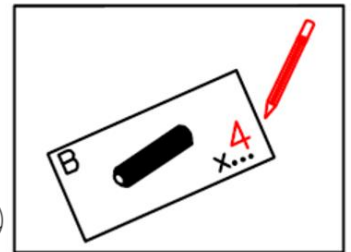
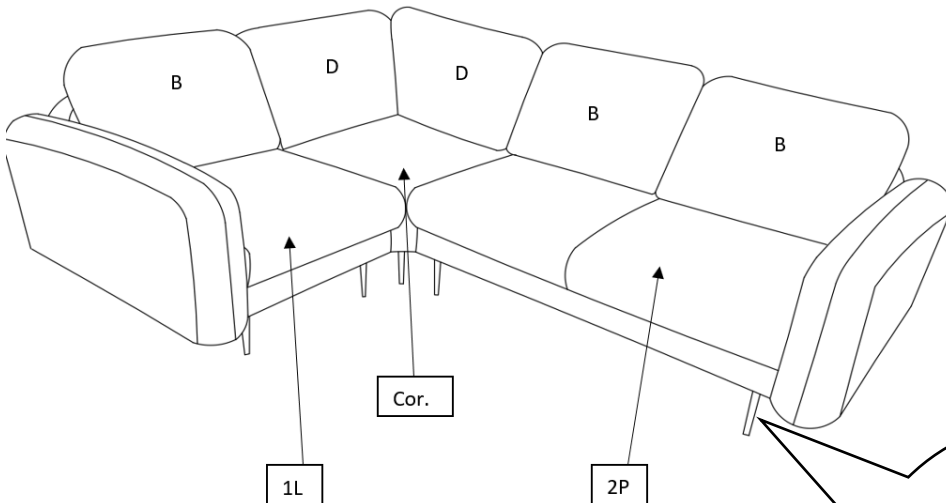
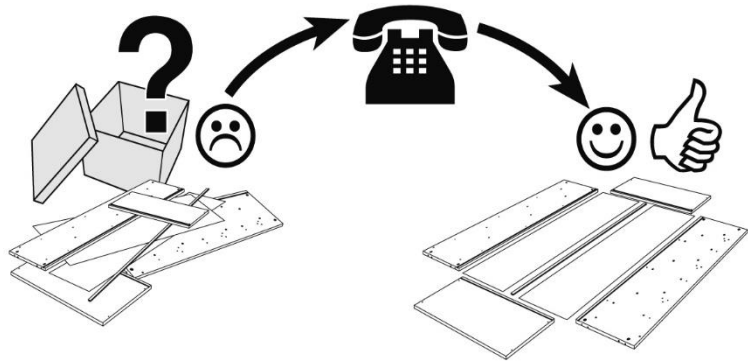
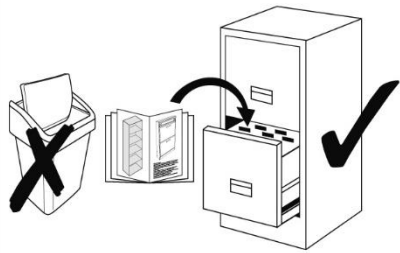

A	..... B	..... C	..... D