

Jerzy 71407

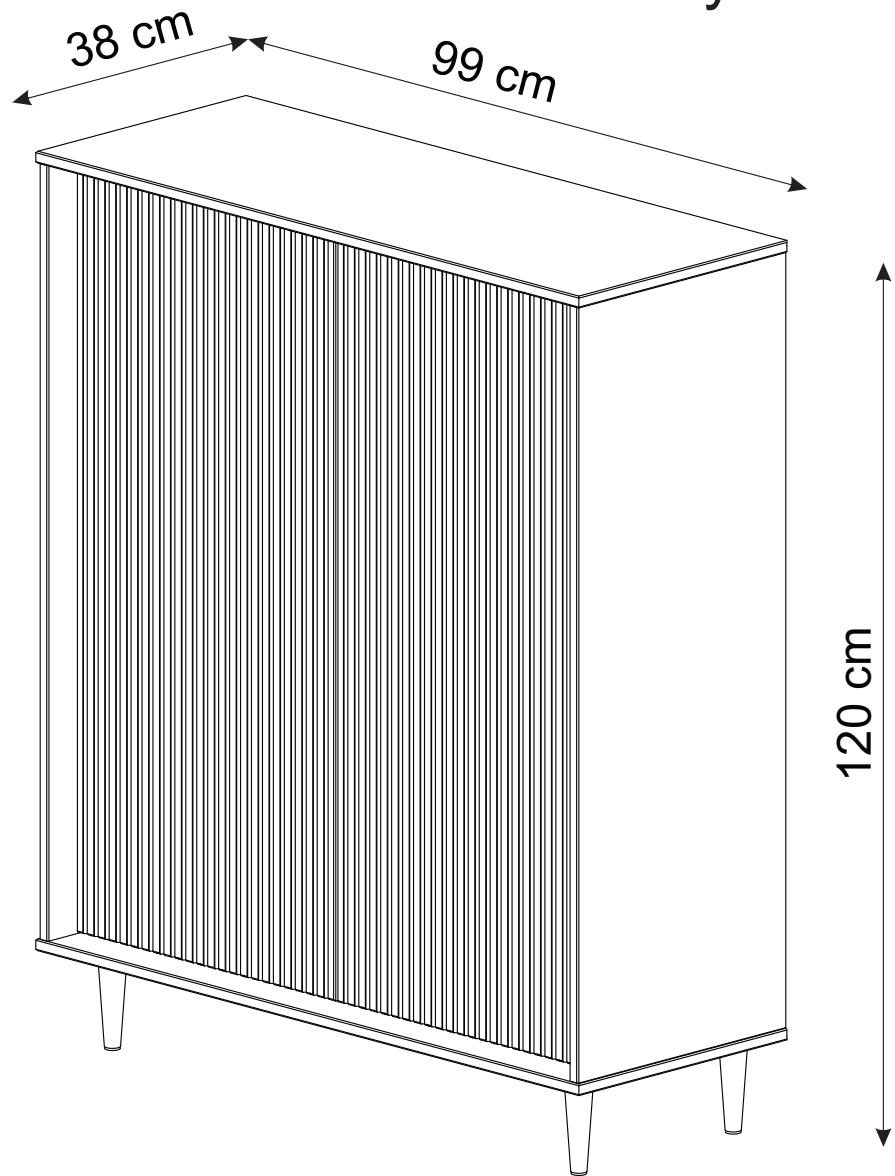

- | | |
|---|-------------------------------------|
| (D) Montageanleitung | (GB) Assembly instructions |
| (FR) Notice de montage | (IT) Istruzioni di montaggio |
| (NL) Handleiding voor de montage | (PL) Instrukcja montażu |
| (CZ) Montážní návod | (SK) Návod na montáž |
| (HU) Szerelési útmutató | (RO) Instrucțiuni de montaj |
| (TR) Montaj talimatı | (RU) Инструкция по монтажу |

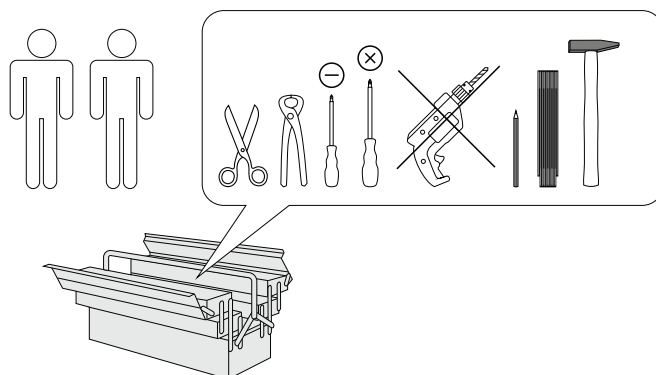

0
10
20
30
40
50
60
70
80
90
100
110
120
130
140
150
160
170
180
190
200

**Service • Assistenza • Dienstverlening • Serwis
Servis • Szerviz • Сервисная служба**

Name • Nom • Nome • Naam • Nazwa • Jméno • Názov • Név • Denumire • Ísim • Название		
Nr. • No. • N° • Номер • Č • Sz		
Typ • Type • Tip • Típus • Tipo • Тип		

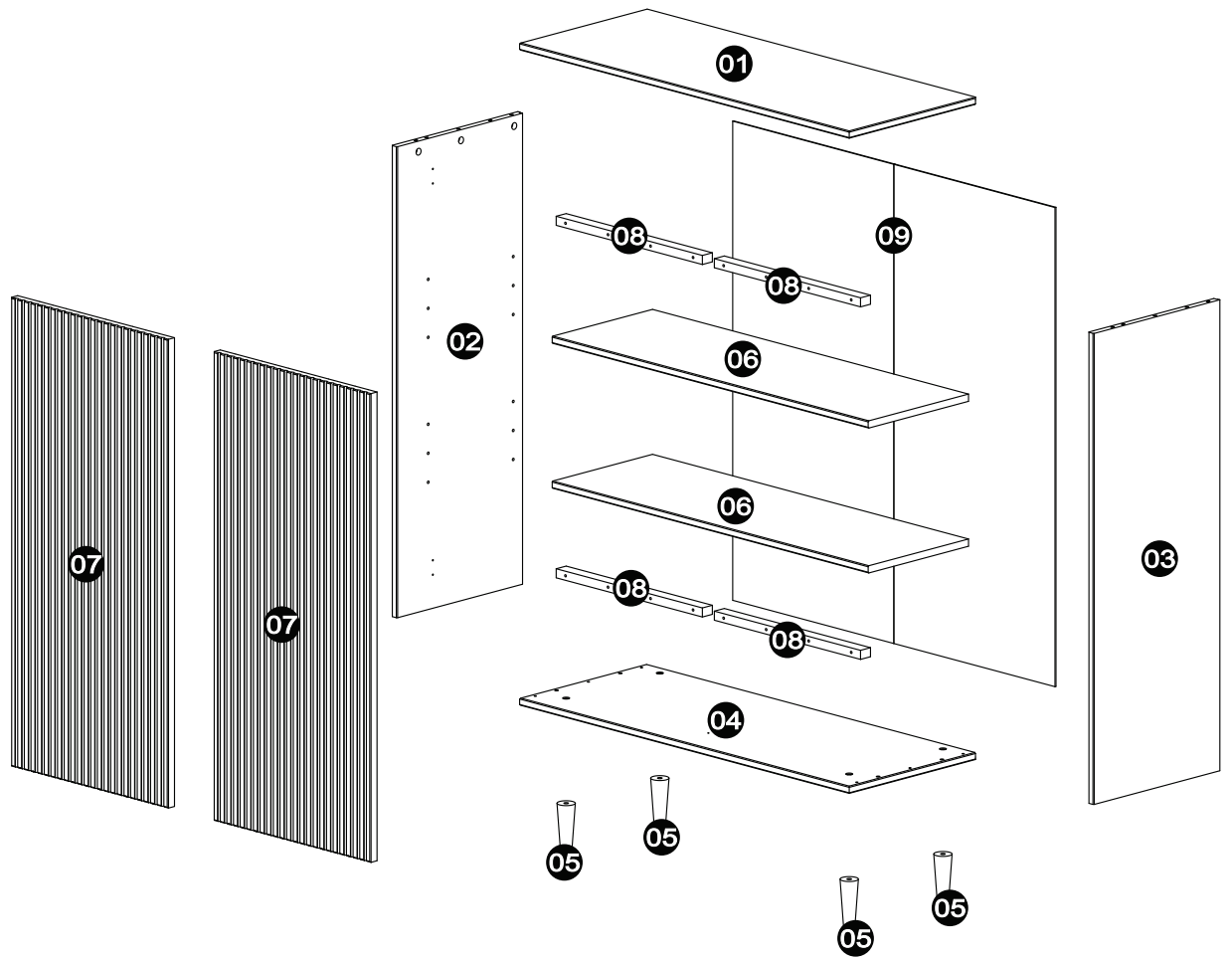

A 8x30 8x	B 6x 6x	C 8x 8x	D 1x 1x	E 3,5x14 28x	F 7x60 4x	G 1x 1x	H 6x 6x	I 4x35 22x
J 8x8 32x	K Ø15 4x	L C12 6x	M 1x 1x	N 4,5x60 1x	O 0.1 2x	O.2 0.2 2x	O.3 3x12 2x	O.4 3,5x14 4x

1

- | | | | | | | |
|------------------------|----------------|----------------|----------------|--------------------------|-----------------------|---------------------|
| A
8x30
8x | B
6x | C
8x | D
1x | E
3,5x14
2x | O
O.1
2x | O.4
3,5x14
4x |
|------------------------|----------------|----------------|----------------|--------------------------|-----------------------|---------------------|

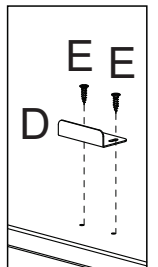
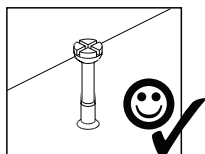
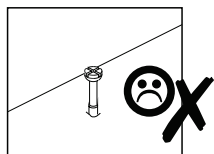
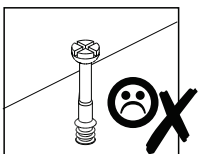
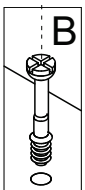
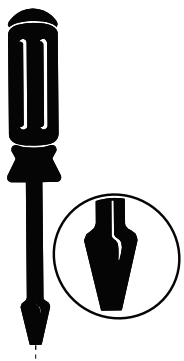
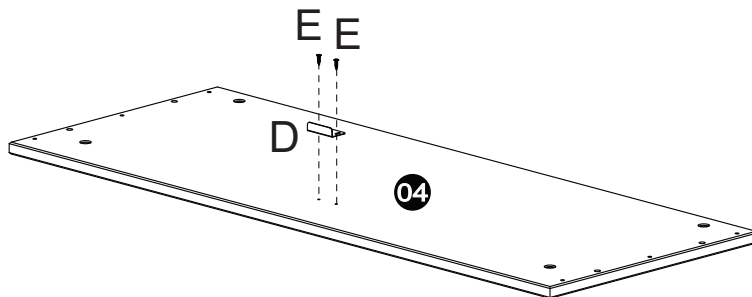
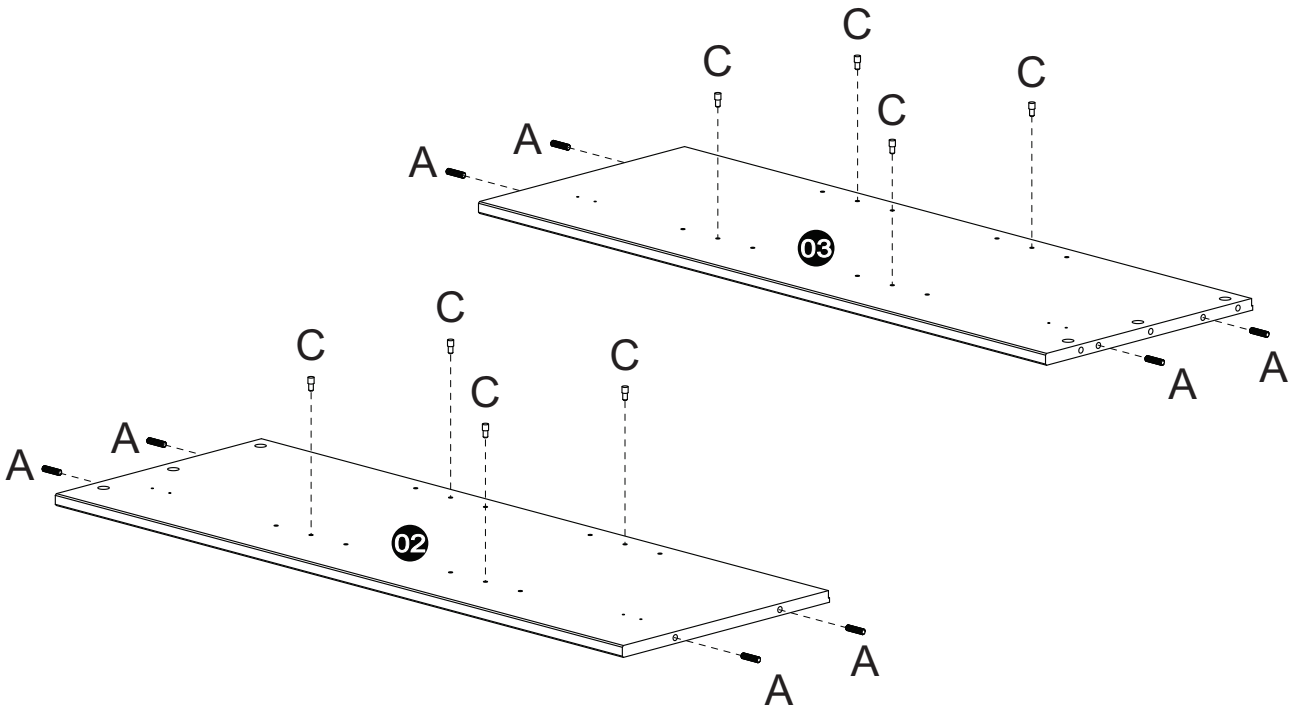
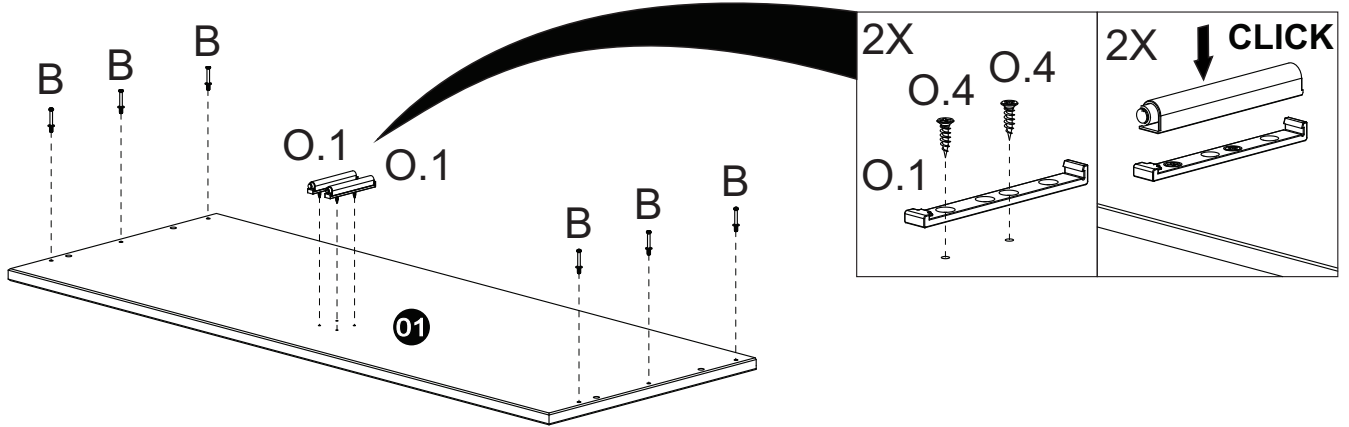

2

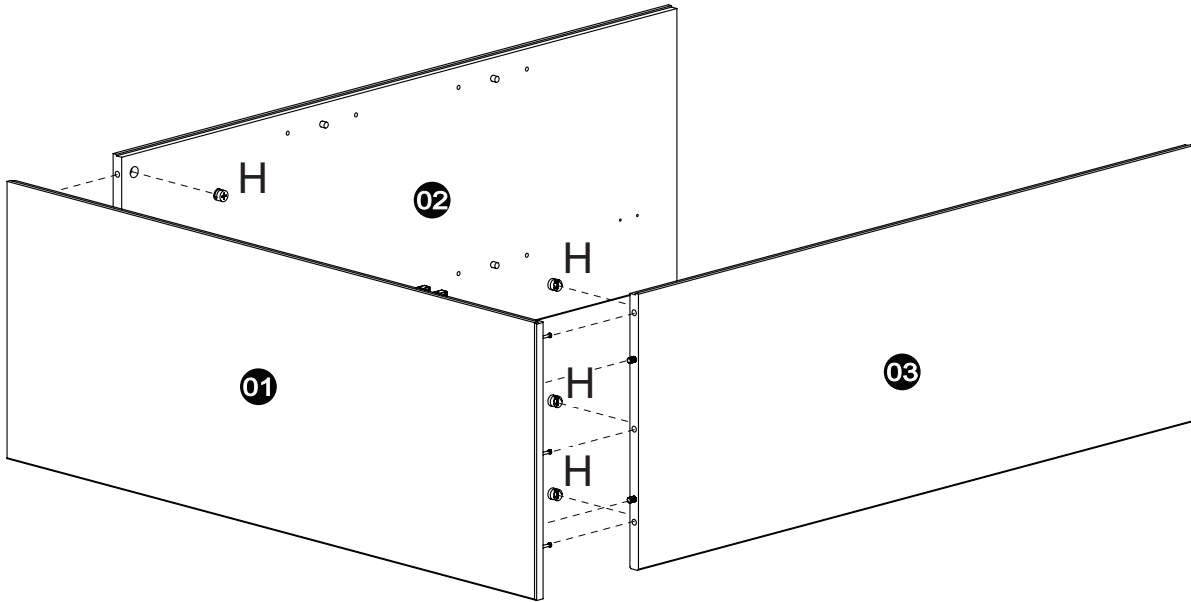
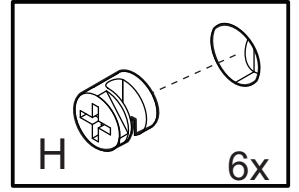
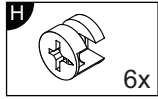

3

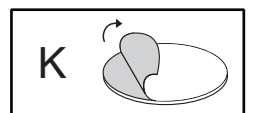
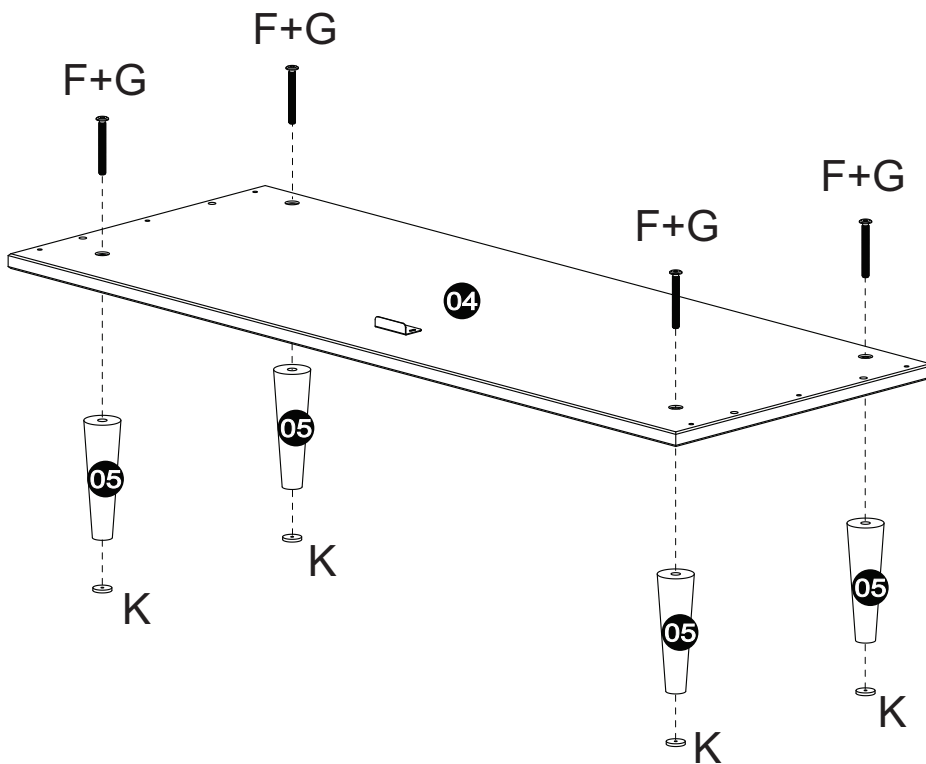
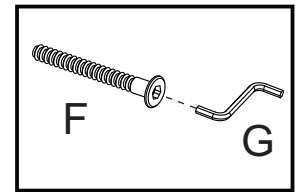
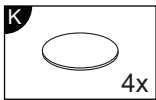
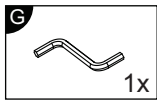
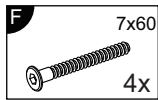

4

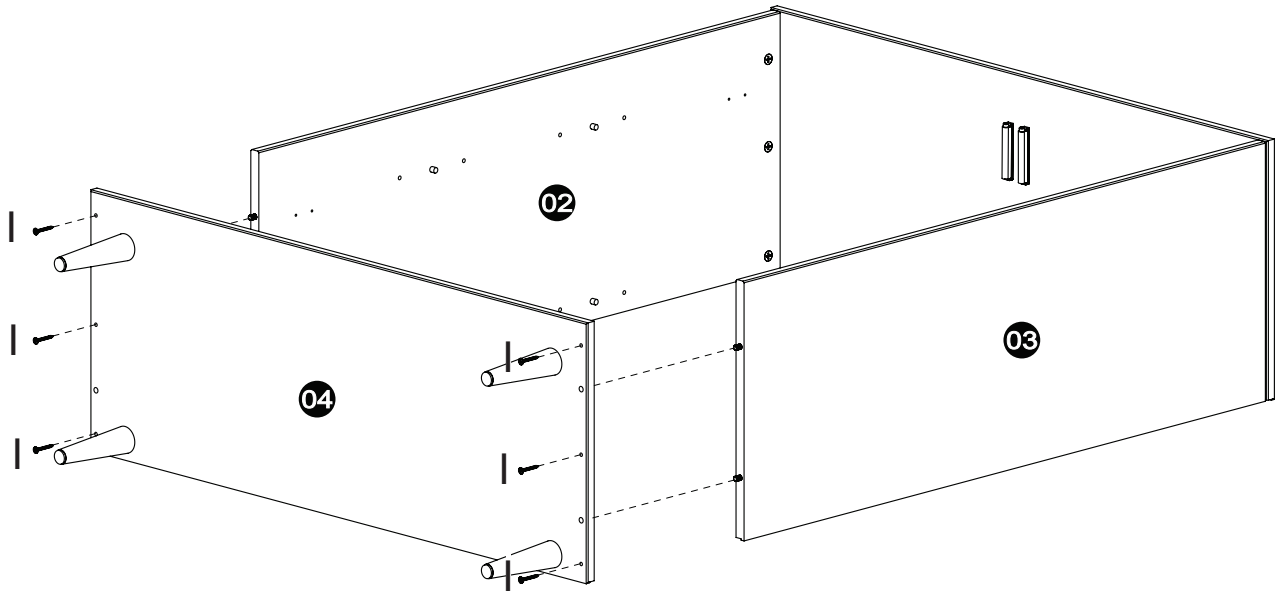
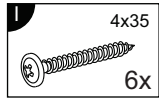

5

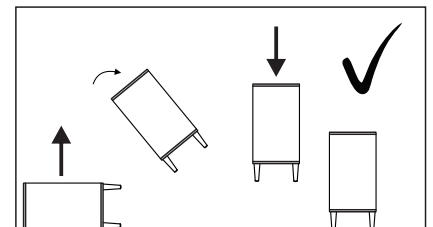
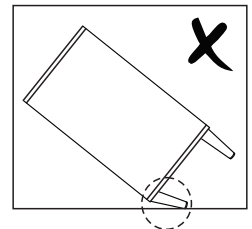
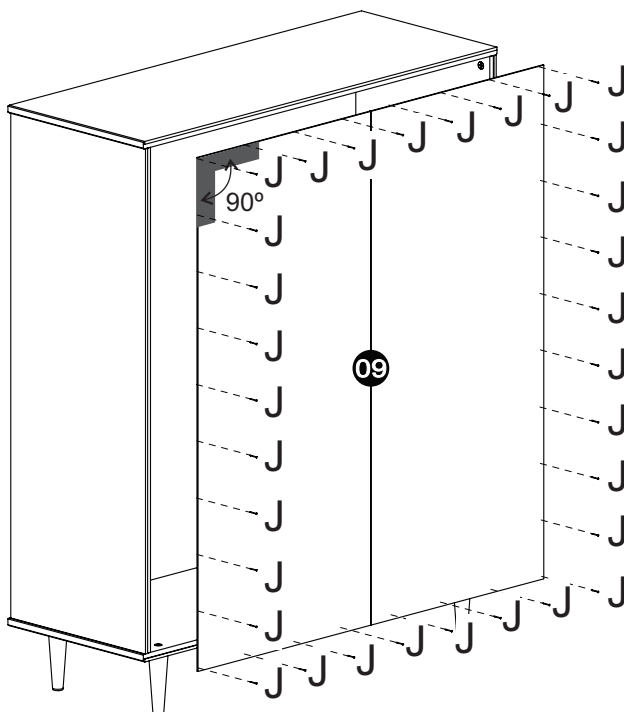
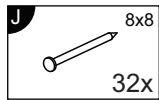

6

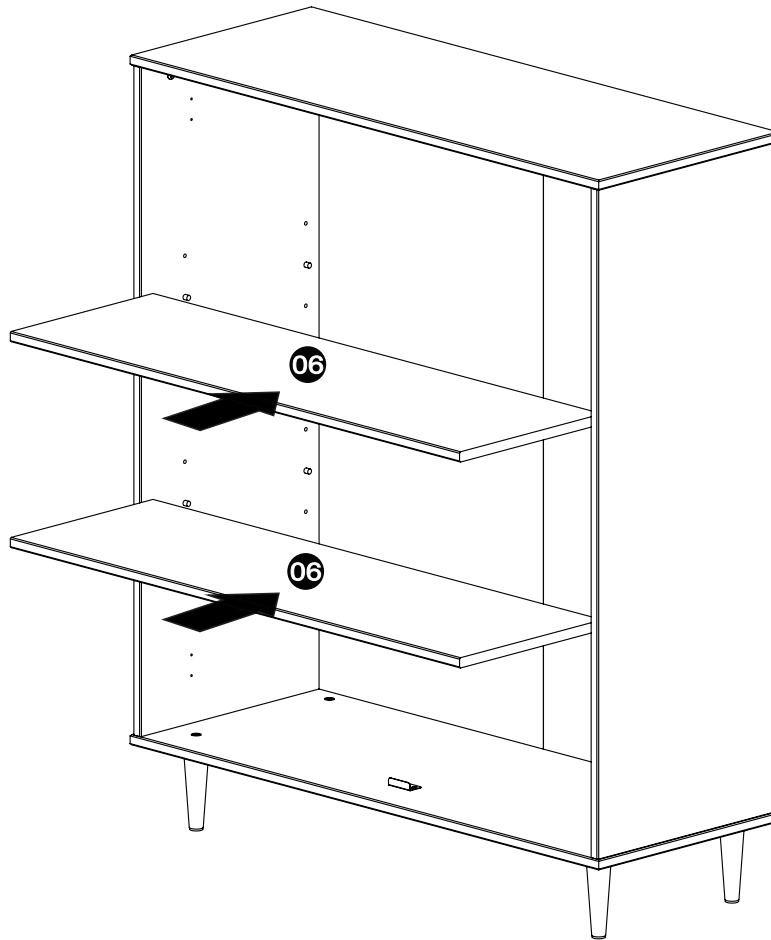

7

E 3,5x14 12x	L 4x35 16x	L C12 6x	P O.2 2x	O.3 3x12 2x
------------------------	----------------------	--------------------	--------------------	----------------

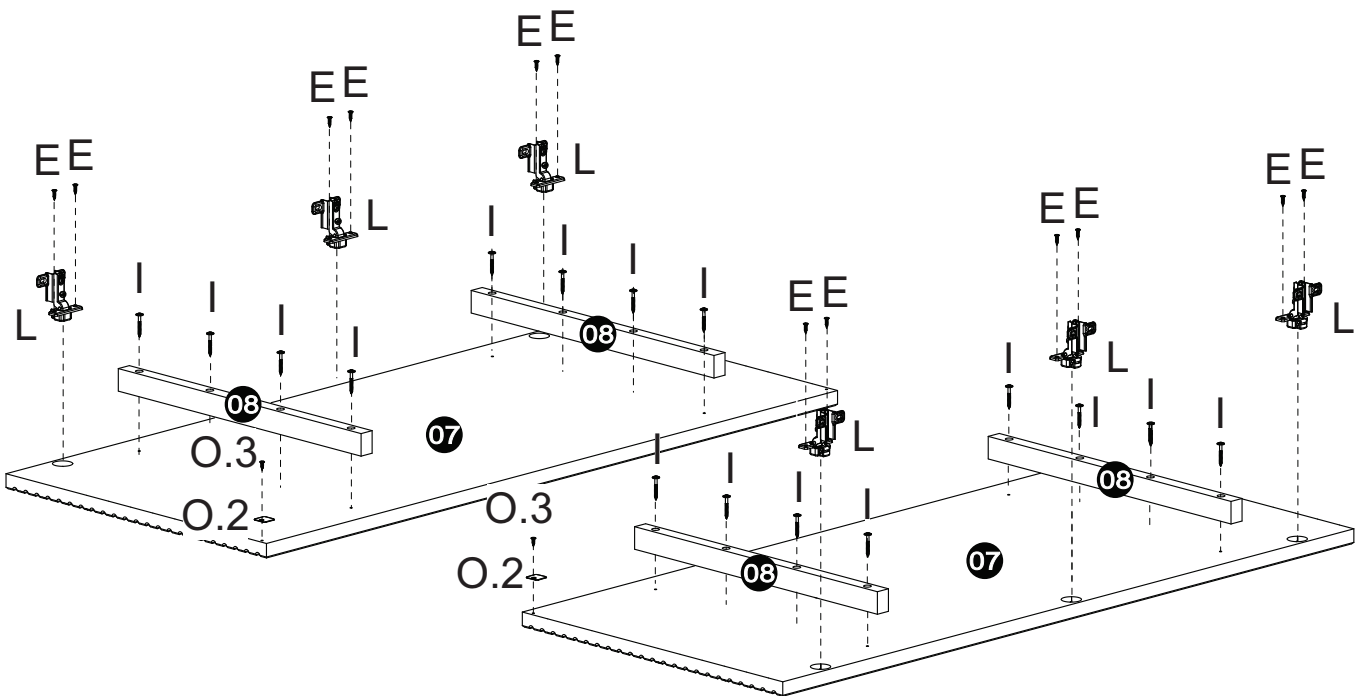

8

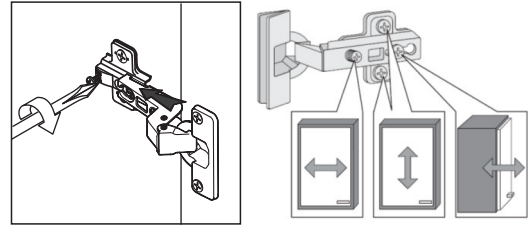
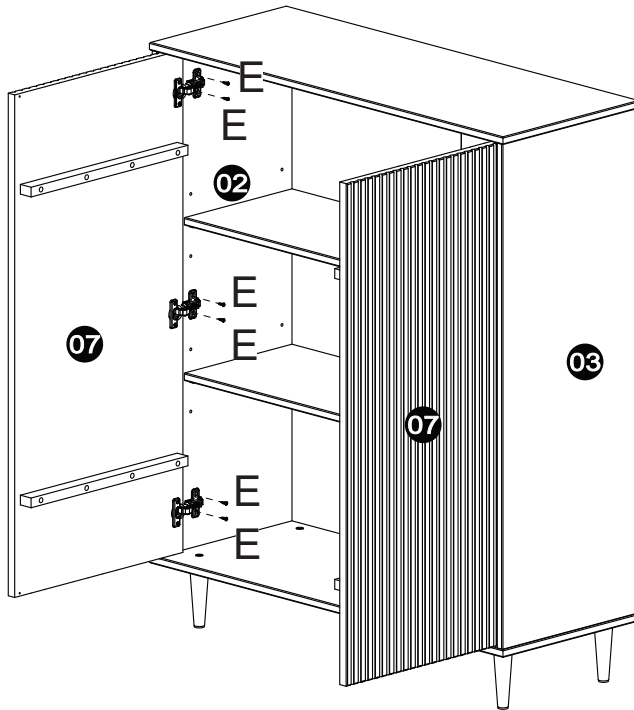
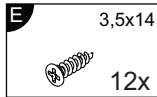

Türen einstellen (Scharniere justieren)
 Adjusting the doors (adjusting the hinges)
 Régler les portes (ajuster les charnières)
 Sistemare le porte (regolare le cerniere)
 Deuren instellen (scharniëren afstellen)
 Nastawić drzwi (wyregulować zawiasy)
 Vyrovnajte dvířka (seřid'te závěsy)
 Nastavenie dverí (nastavenie závesov)
 Állítsa be az ajtókat (állítsa be a zsanérokat)
 Reglare ușii (ajustare balamale)
 Kapıların ayarlanması (menteselerin seviye ayarı)
 Регулировка Дверей (регулировка шарнира)

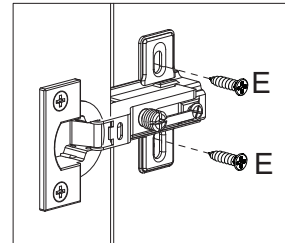

9

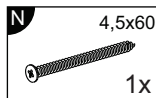
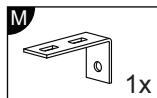
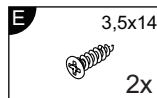

Achtung • Attention • Attenzione Opgelet • Uwaga • Pozor • Figyelem Atenție • Dikkat • Внимание	
(D)	Wandbefestigung dient als Kippschutz – unbedingt anbringen! Bei einigen Wandtypen kann ein Spezialdübel erforderlich sein!
(GB)	The wall fastening serves to prevent tipping – be absolutely sure to mount it! For certain wall types, a special wall plug may be necessary!
(FR)	La fixation murale sert de protection contre le basculement – à installer impérativement ! Pour certains types de murs il faut des chevilles spéciales !
(IT)	Il fissaggio alla parete serve da protezione anti-ribaltamento – attaccarla assolutamente! Per alcune strutture di parete può essere necessario un tassello speciale!
(NL)	Bevestiging aan de muur dient als kantelbescherming – zeker en vast bevestigen! Bij enkele muurtypes is een speciale plug mis-schien vereist!
(PL)	Mocowanie do ściany jest jednocześnie zabezpieczeniem przed przewróceniem – koniecznie zamontować! Do niektórych rodzajów ścian koniecznie zastosować specjalne kolki mocujące.
(CZ)	Montáž na stěnu slouží jako ochrana proti převrnutí – bezpodmínečně umístěte! U některých typů stěn může být zapotřebí speciální hmoždinka!
(SK)	Upevnenie na stenu slúži ako ochrana proti prevráteniu – bezpodmienečne použite! Pre niektoré druhy stien môže byť potrebná špeciálna hmoždinka!
(HU)	A terméket a falhoz kel rögzíteni, különben az felborulhat! Egyes faltípusoknál speciális tiplít kell használni!
(RO)	Sistemul de fixare la perete servește ca protecție la răsturnare – de montat obligatoriu! Pentru unele tipuri de pereți este posibil să fie necesar un diblu special!
(TR)	Duvardaki sabitleme, devrilmeye karşı bir emniyet tedbiridir ve mutlaka monte edilmelidir! Bazı duvar tiplerinde bunun için özel bir dübel gerekli olabilir!
(RU)	Обязательно установите крепление на стене во избежание опрокидывания! Для некоторых типов стен может потребоваться специальный дюбель!

