

Art.nr. 1032041501

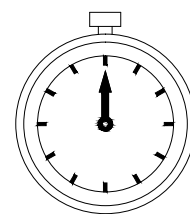

60 min

Achtung bei Reklamationen bitte den EAN rausschneiden und zurücksenden
und die Montageanleitung beifügen

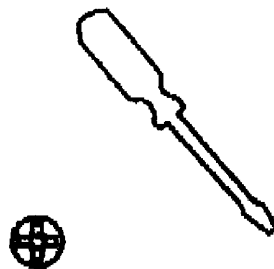
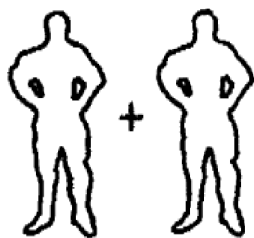

- | | | | | |
|----------------|---------------------------|------------------------|----------------|------------------------|
| A
x4 | B
x4 | C
x8 | D
x8 | E
8x32
x2 |
| F
x8 | G
3.5x15
x16 | H
SW 6
x1 | I
x8 | J
x4 |
| K
x4 | L
x16 | | | |

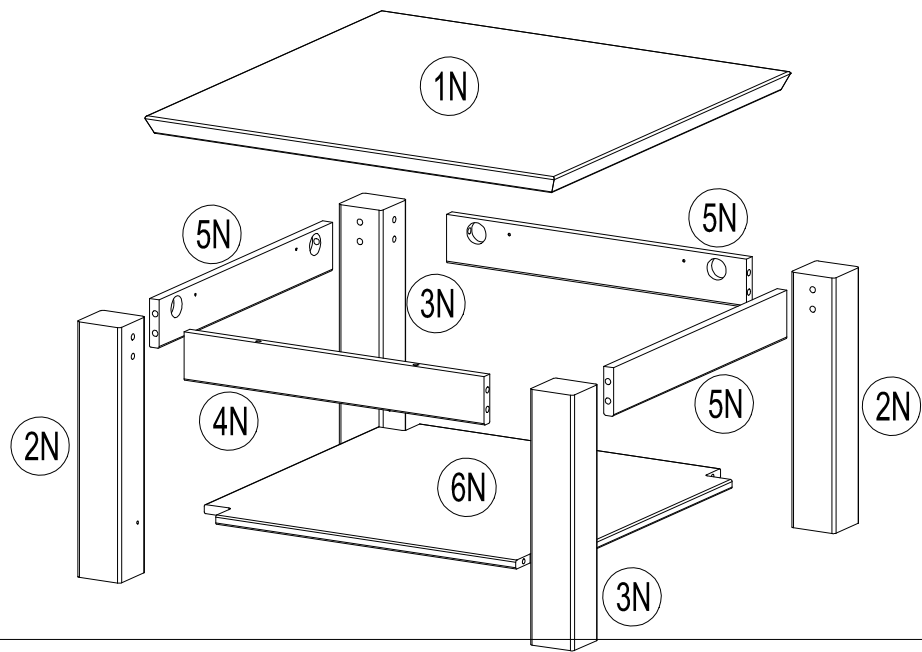

- | | | | | | | |
|----------|----------------|----------------|----------------|------------------------|----------------|--------------------------|
| 1 | A
x4 | C
x8 | D
x8 | E
8x32
x2 | F
x8 | G
3.5x15
x8 |
|----------|----------------|----------------|----------------|------------------------|----------------|--------------------------|

- | | | |
|----------------|----------------|-----------------|
| I
x8 | K
x4 | L
x16 |
|----------------|----------------|-----------------|

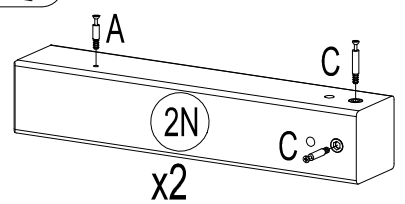
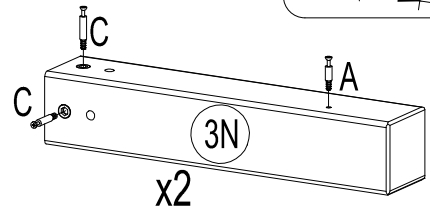
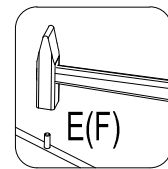
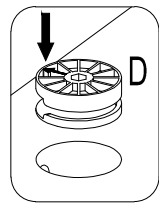
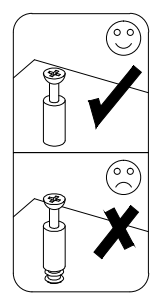
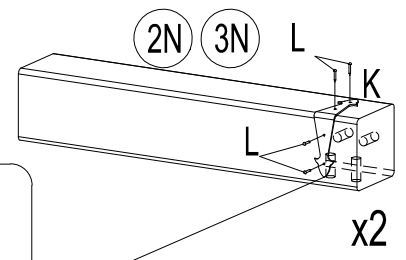
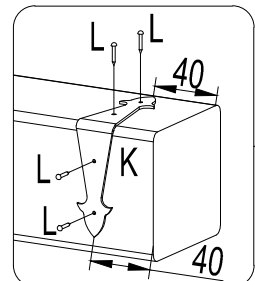
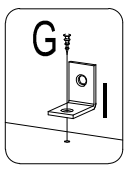
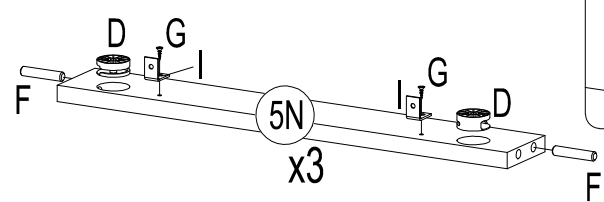
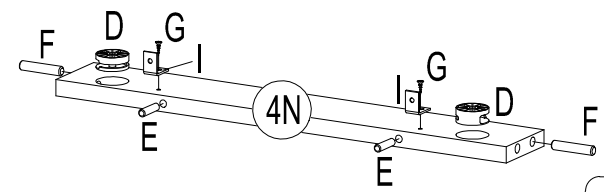

2

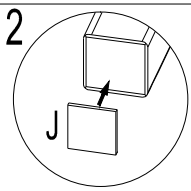
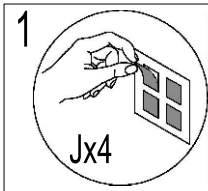
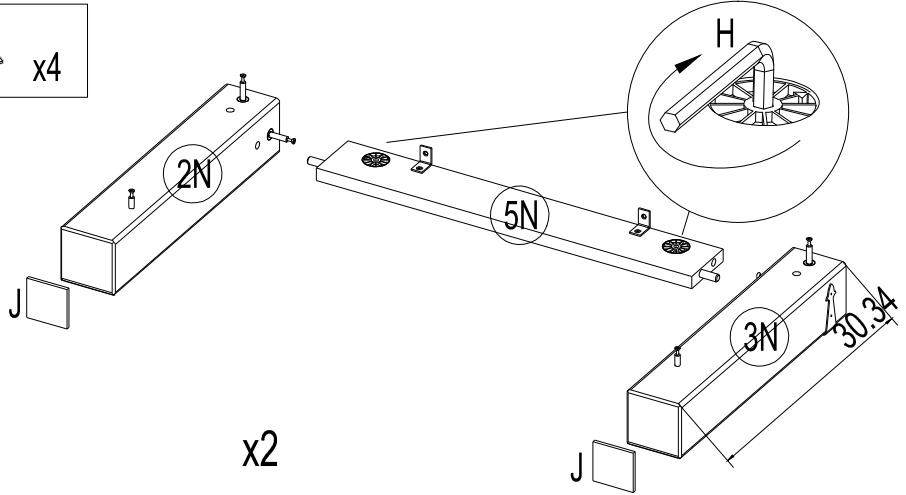
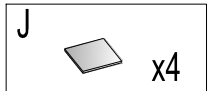
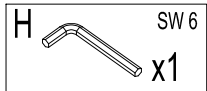

x2

3

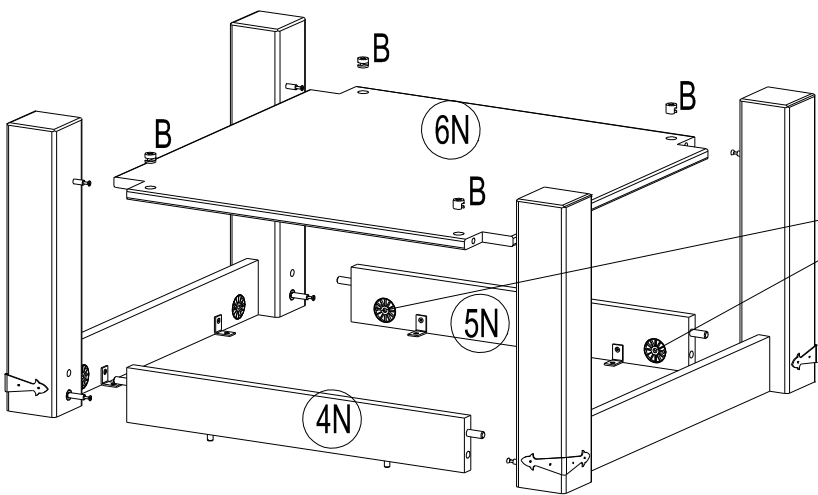
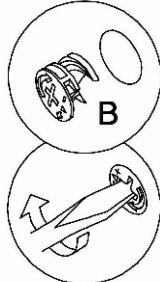
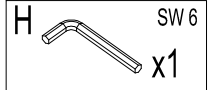

4

