

# Kira

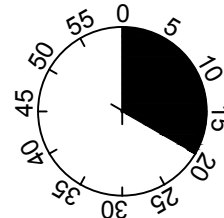
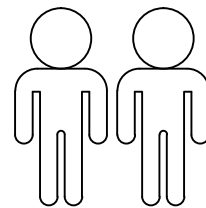
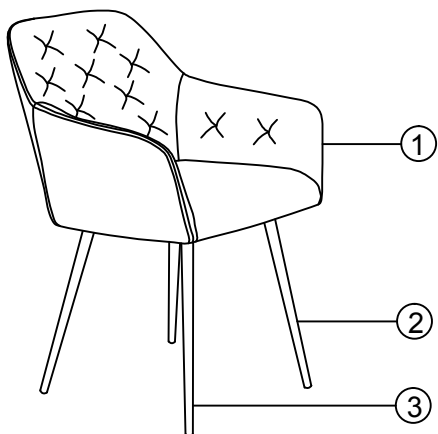

1

2

3

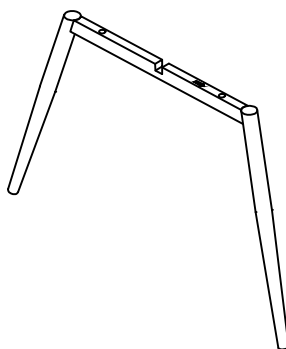
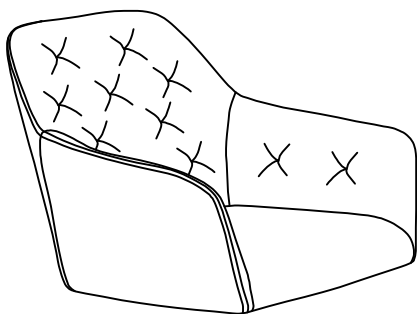

R

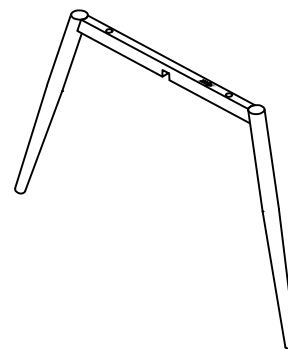

L

1	1 x
2	1 x
3	1 x

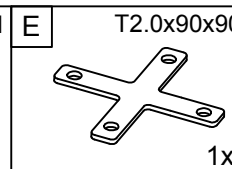
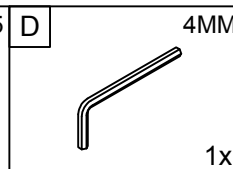
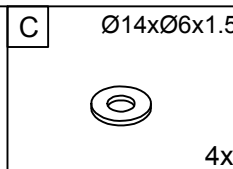
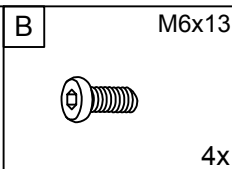
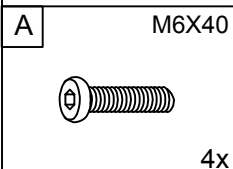

**I.**

**1**

2

3

D

B

F

R

L

**B** M6x13  
4x

**D** 4MM  
1x

**E** T2.0x90x90  
1x

75%

**2**

1

D

A

C

**A** M6x40  
4x

**C** Ø14xØ6x1.5  
4x

**D** 4MM  
1x

75%

**3**

**D** 4MM  
1x

100%

