

ACHTUNG:
Bei Modellen mit losen Kissen wird die Kopfstütze hinter die Rückenkissen gestellt. Es ist keine Tasche im Rückenkorpus eingenäht.

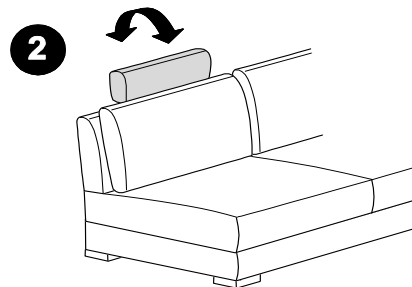

30.11.2011

Stand

00

Revision

VHÖ

Verfasser

1 / 1

Seite(n)

Bedienungsanleitung Elementverbinder

Bezeichnung

FOB_MO_0004

lfd. Nr.

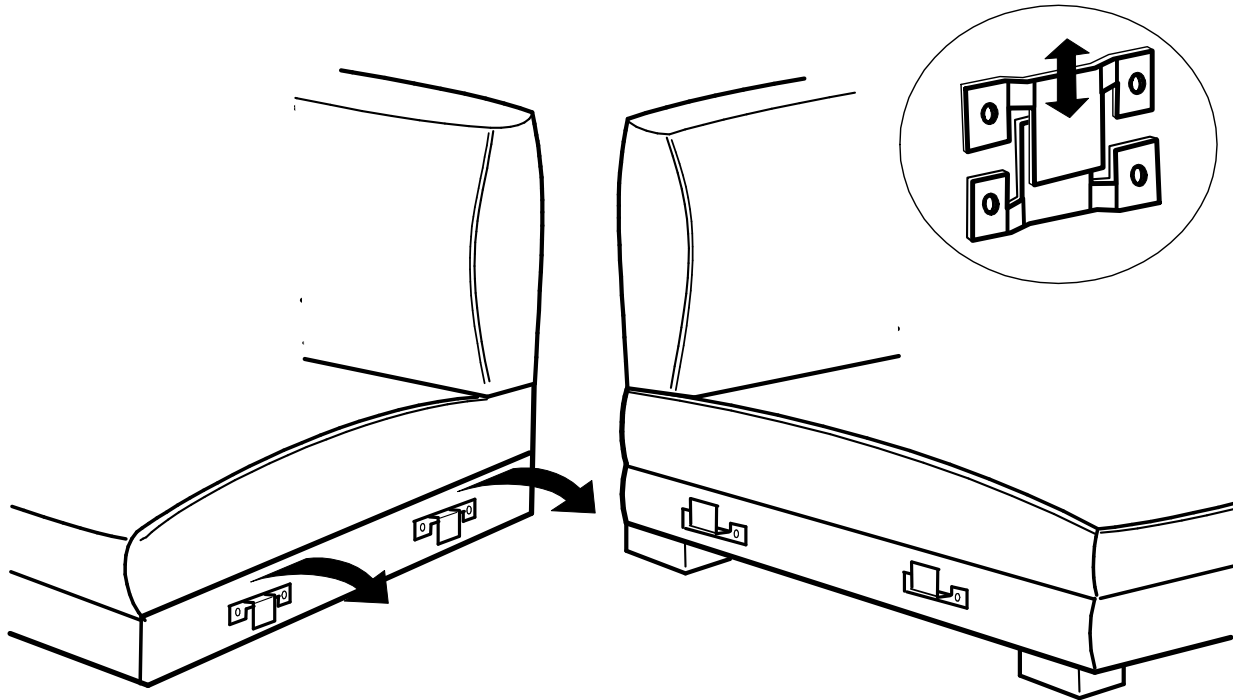

21.11.2012

Stand

00

Revision

VFR

Verfasser

1 / 1

Seite(n)

Montageanweisung höhenverstellbarer Stützfuß

Bezeichnung

FOB_MO_0008

lfd. Nr.

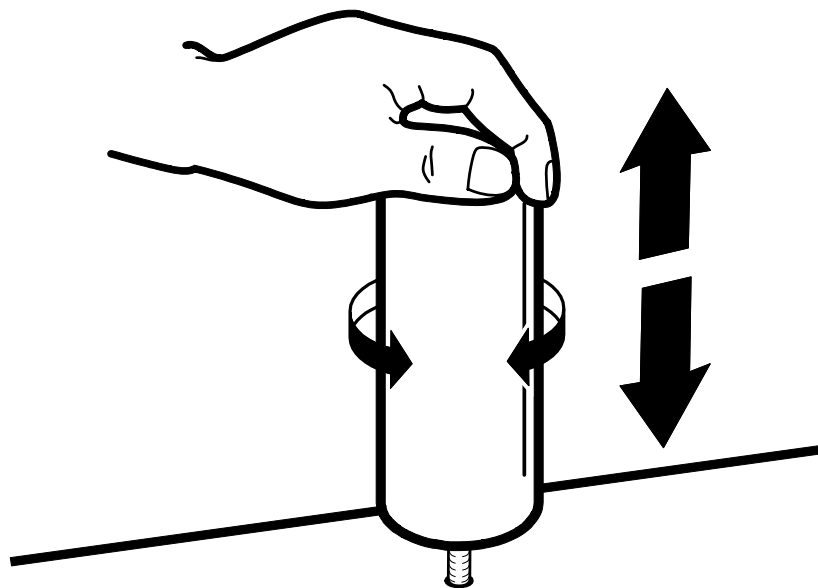

25.03.2013

Stand

00

Revision

APO

Verfasser

1 / 1

Seite(n)

höhenverstellbarer Stützfuß

Bezeichnung

FOB_MO_0011

lfd. Nr.

1

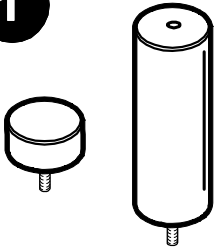

2

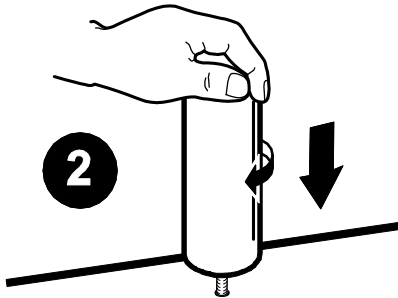

3

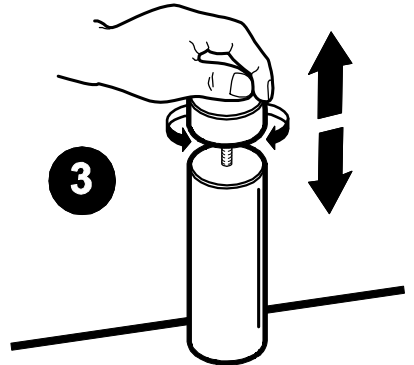

DE Fuß / Position

EN Foot / Position

NL Poot / Positie

IT Piedi / Posizione

RU Ноги / Позиция

FR Pied / Position

ES Pie / Posición

TR Ayak / Pozisyon

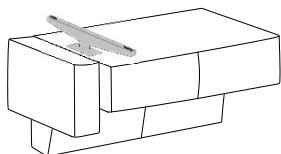

2-Sitzer mit AL links/rechts
RTV manuell oder motor

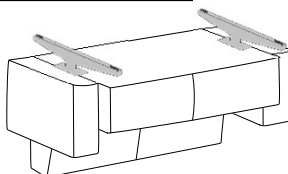

2-Sitzer mit 2 Armlehnen
RTV manuell oder motor

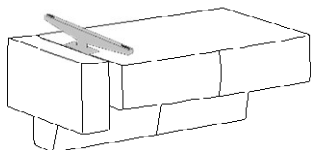

2,5-Sitzer mit AL links/rechts
RTV manuell oder motor

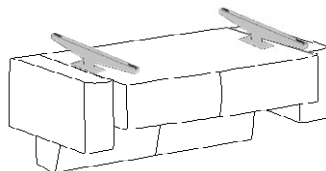

2,5-Sitzer ohne Armlehnen
RTV manuell oder motor

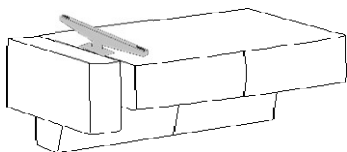

3-Sitzer ohne Armlehnen

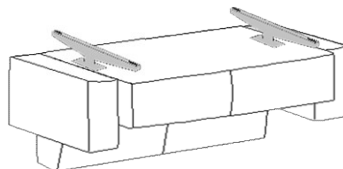

3-Sitzer mit AL links/rechts

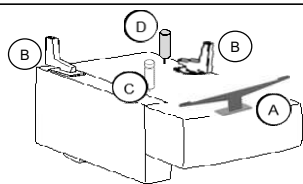

Eckelement + 1-Sitzer mit Abschlussteil
Fest oder RTV manuell

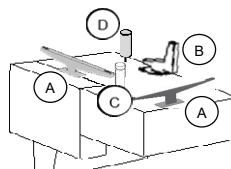

Longchair mit Armlehne li./re.

A	Höhe 15/18cm	B	Höhe 15/18cm	C	Höhe 15/18cm	D			Modellnummer 15004
									Stand 08.04.2021
Metallkufe		Stützfuß		Kunststoff		Kunststoff			Revision 00
Kundenseitig		Kundenseitig		Kundenseitig		Kundenseitig			Verfasser JMA

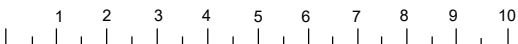

DE Fuß / Position

EN Foot / Position

NL Poot / Positie

IT Piedi / Posizione

RU Ноги / Позиция

FR Pied / Position

ES Pie / Posición

TR Ayak / Pozisyon

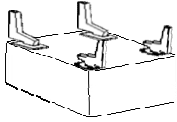

Hocker

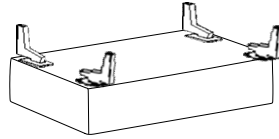

Hockerbank



Metallfuß 346 , 702 H-150

Metallfuß 283 , 284 H-180



Metallkufe 425 , 426 H-150

Metallkufe 459 , 460 H-180



Kunststoff-Stützfuß

Montage

A Höhe 15/18cm	B Höhe 15/18cm	C Höhe 15/18cm	D		Modellnummer 15004
					Stand 08.04.2021
Metallkufe Kundenseitig	Metallfuß Kundenseitig	Stützfuß Kundenseitig	Kunststoff Kundenseitig		Revision 00
					Verfasser JMA

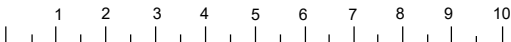

23.10.2017

Stand

01

Revision

MVI

Verfasser

1 / 1

Seite(n)

Armlehnenfunktion

Bezeichnung

FOB_BE_0015

lfd. Nr.

