

-21P1

Montageanweisung / Installation instructions / Instruction de montage / Istruzioni di montaggio
montagehandleiding / Instrukcja montażu / Montaj talimatlar / Osszeszerelési útmutató / Nàvod k montáži /
Nàvod na montáž / Instrucțiune de montaj / Инструкция по монтажу / Montaj talimatina / Monteringsanvisningar
Upute za montažu / Instrucciones de Montaje / Navodila za montažo

AMBURGO

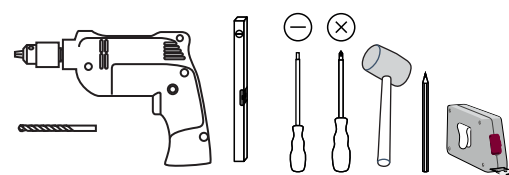
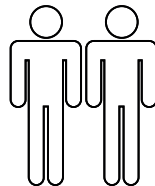
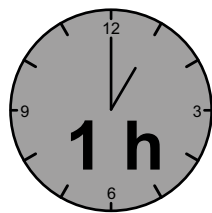

LC S.p.A
Via del Piano s.n
61030 Isola del Piano (PU)
Italia
<http://www.lcmobili.com/>

D – bitte lesen sie diese montageanleitung gut durch,
Da wir für fehler, die durch falsche montage entstehen,
Keine haftung übernehmen!

Gb – please read these installation instructions
Through carefully as we cannot accept any liability
For faults occurring as a result of incorrect installation!

Cz – přečtěte si prosím pozorně tento návod k montáži,
Aby jste předešli chybám vzniklých špatnou montáží,
Za které neručíme!

F – veuillez lire attentivement cette notice de montage,
Car nous déclinons toute responsabilité en cas d'erreurs
Découlant d'un montage erroné !

I – prego leggere attentamente le istruzioni per il montaggio,
Poiché decliniamo qualsiasi responsabilità
Per difetti derivanti da montaggio errato.

S - läs monteringsanvisningarna noggrant.
Vi avsåger oss allt ansvar för defekter som
Uppstår p.g.a. Felaktig montering.

Hr – pažljivo pročitajte upute za montažu,
Jer otklanjamo svaku odgovornost za pogreške
Nastale uslijed pogrešne montaže.

Slo – prosimo, da pozorno preberete navodila za montažo,
Saj zavračamo vsakršno odgovornost za napake,
Ki bi nastale zaradi napačne montaže.

NI – leest u alstublieft deze montagehandleiding goed door,
Voor fouten door verkeerde montage zijn wij niet verantwoordelijk.

Pl – prosze uwaznie zapoznac sie z instrukcja montazu,
Poniewaz nie ponosimy odpowiedzialnosc za niewlasciwy montaz.

HU – Kérjük, olvassa el figyelmesen
ezt az összeszerelési útmutatót,
mert a helytelen összeszerelésből
a dódó hibákért nem vállalunk felelősséget!

SK – Prosíme, dobre prečítajte si tento návod na montáž,
pretože nepreberáme žiadne ručenie za chyby,
ktoré vzniknú na základe chybnej montáže!

RO – Vă rugăm să cititi cu atenție aceste instrucțiuni
de montaj deoarece nu preluăm garanția pentru defecte
ce apar datorită unui montaj incorect!







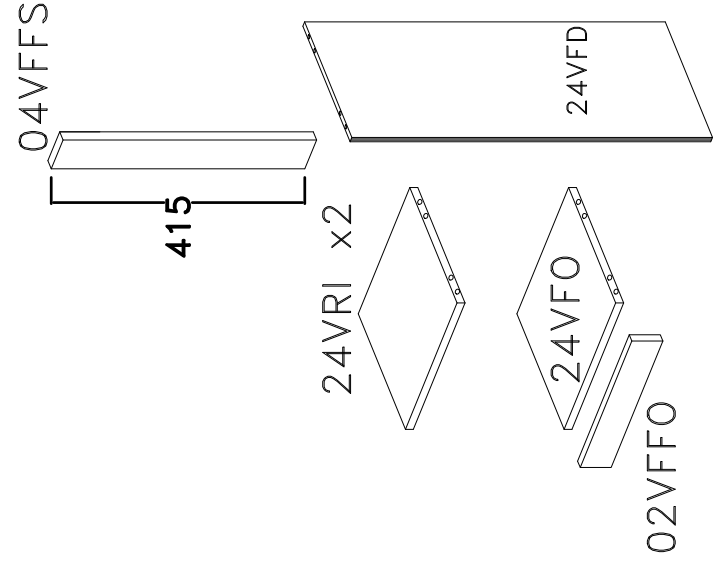
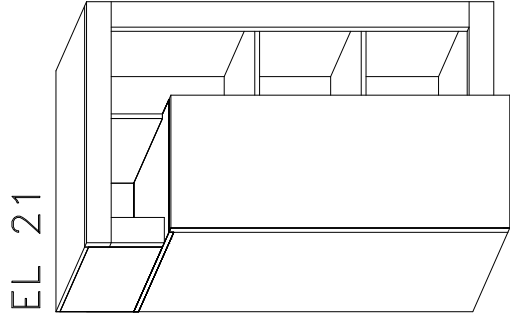
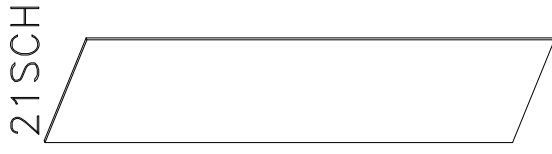
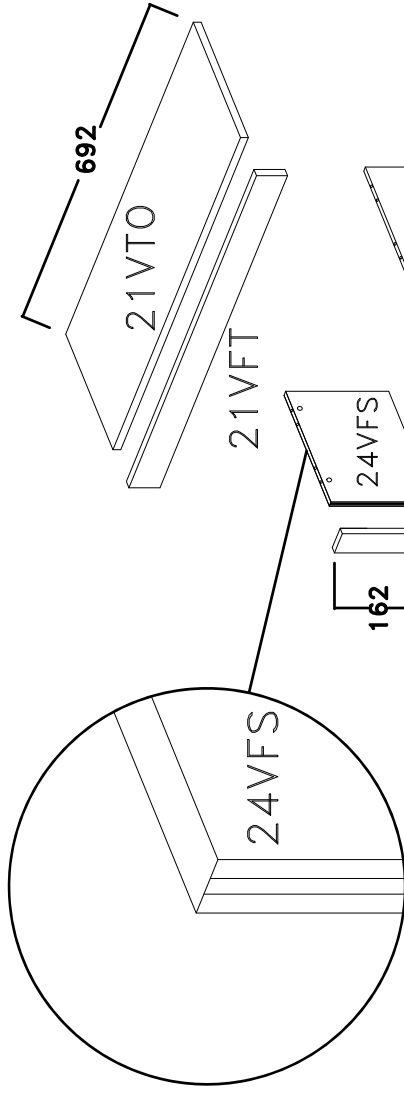

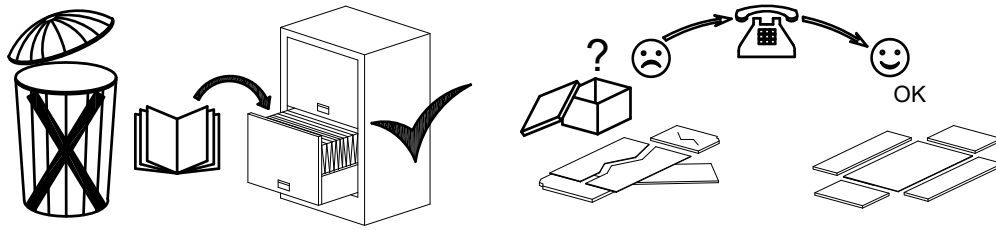

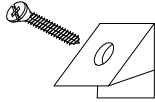
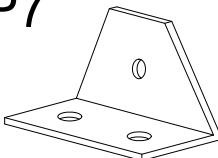
RUS – Пожалуйста, внимательно ознакомьтесь ù
с данной инструкцией по монтажу, поскольку мы не
несем ответственности за ошибки, причиной которых
является неправильный монтаж.

TU – İlkonce kullanma klavuzunu iyi okkuyun,
yalnis montaj yapasaniz bunun sorumlusu biz degiliz.

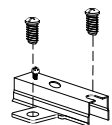
ES – Se ruega leer con atención las instrucciones
de montaje debido a que declinamos cualquier
responsabilidad
por defectos derivados de un montaje erróneo.

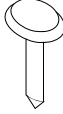
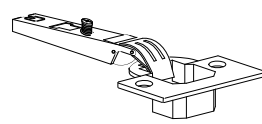
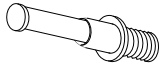

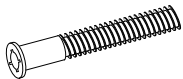
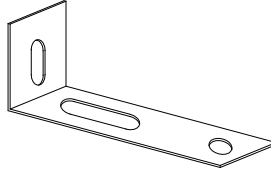
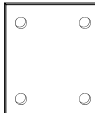
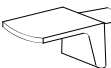

F		x18	P7		x8	L15		4x15 mm.	x4
B		8x30 mm. x30	L418		4x18 mm. x26	H2E		x2	
C		ø15 mm. x16	CH		x6	C0		x2	
D		x16	P		x2				
E		7x60 mm. x14	PST		x1				
PST		x2	R		x8				
L416		4x16 mm. x8							

1

B

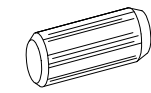

8x30 mm.

x16

H2E

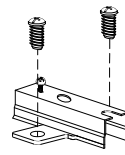

x2

R

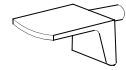

x8

D

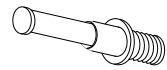

x8

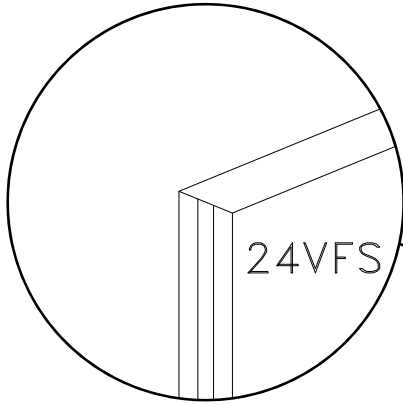

24VFS

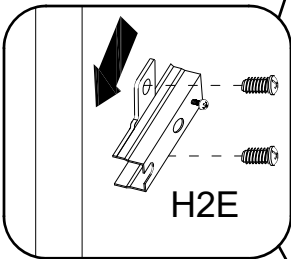
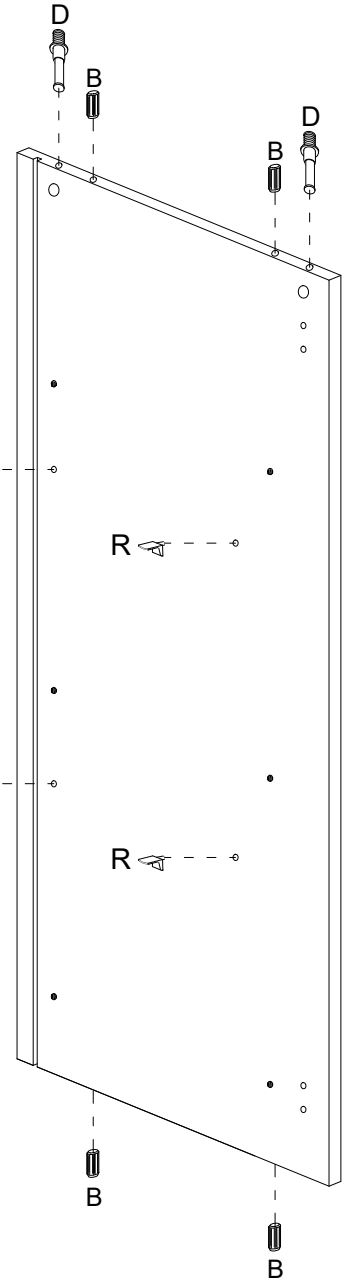
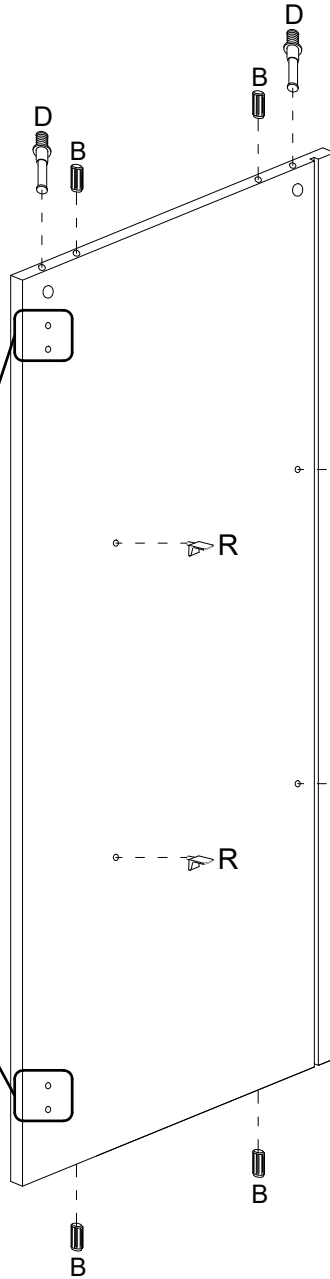
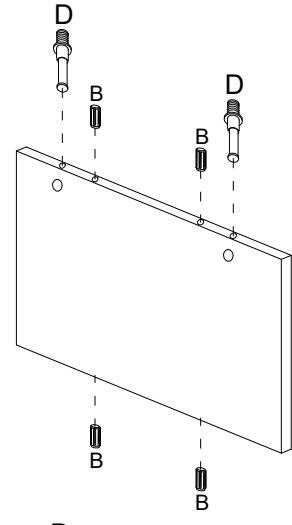
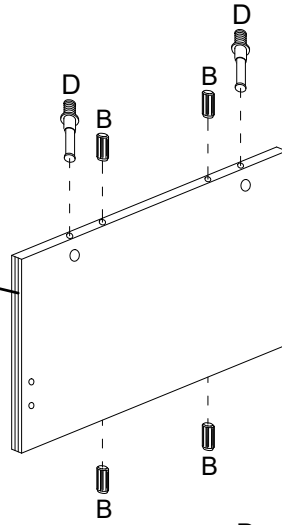

H2E

R

R

R

R

R

R

R

R

2

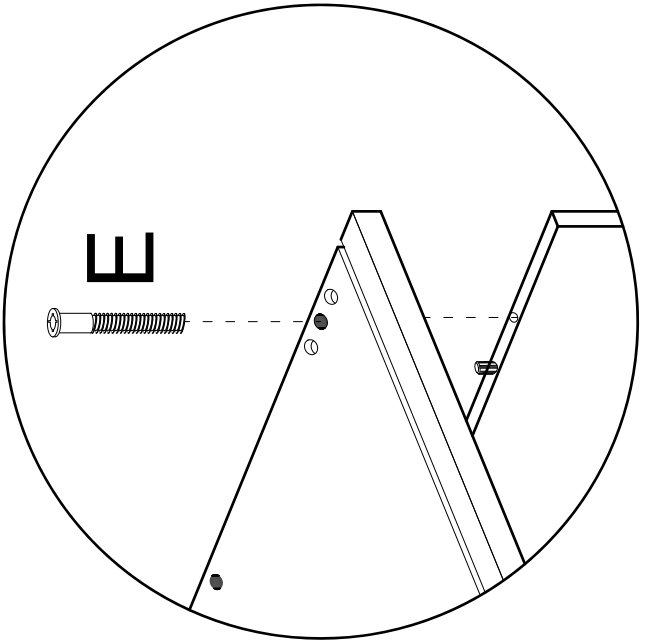
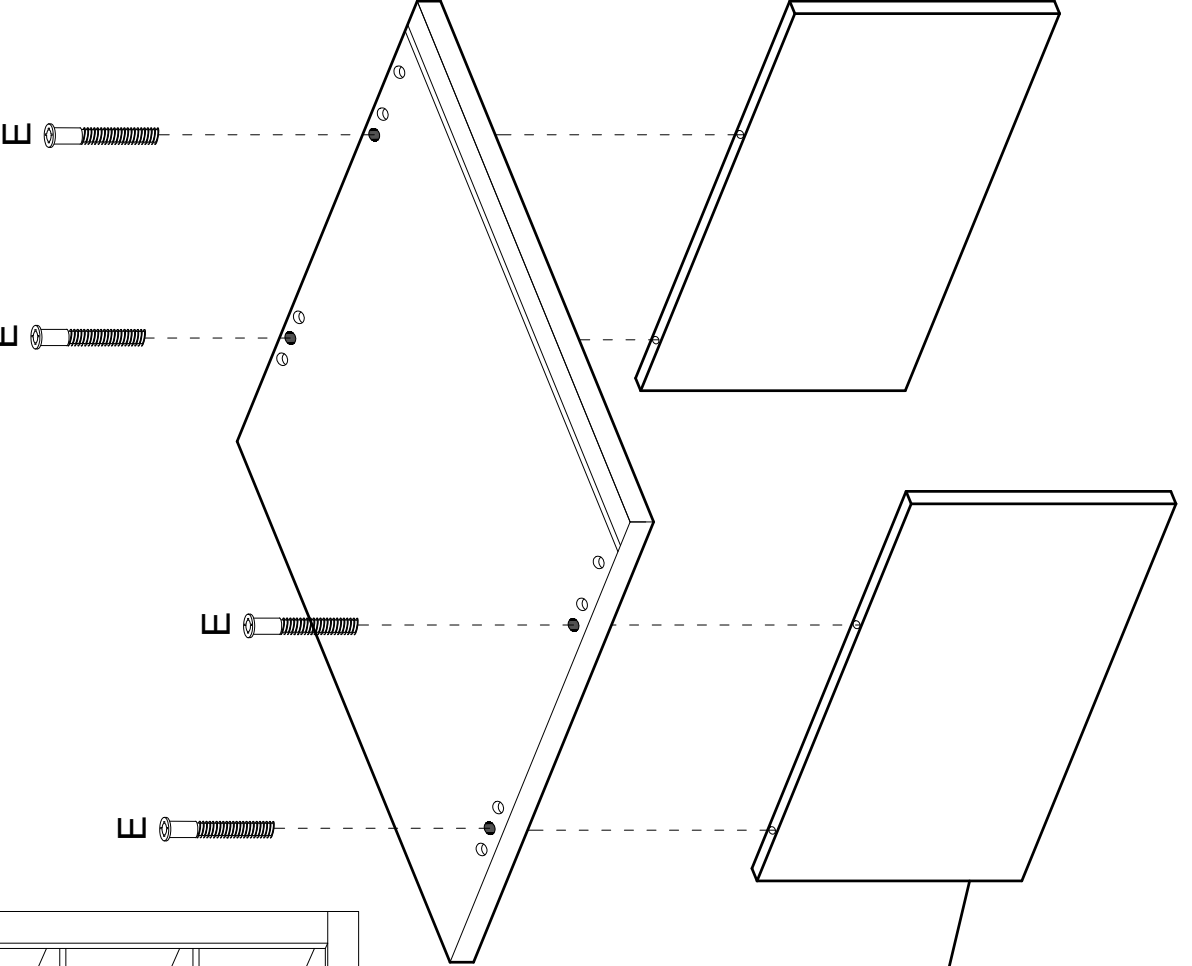
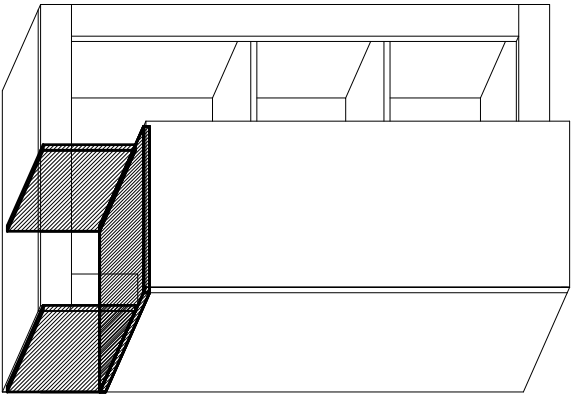

E



7x60 mm.

X4

24VFS

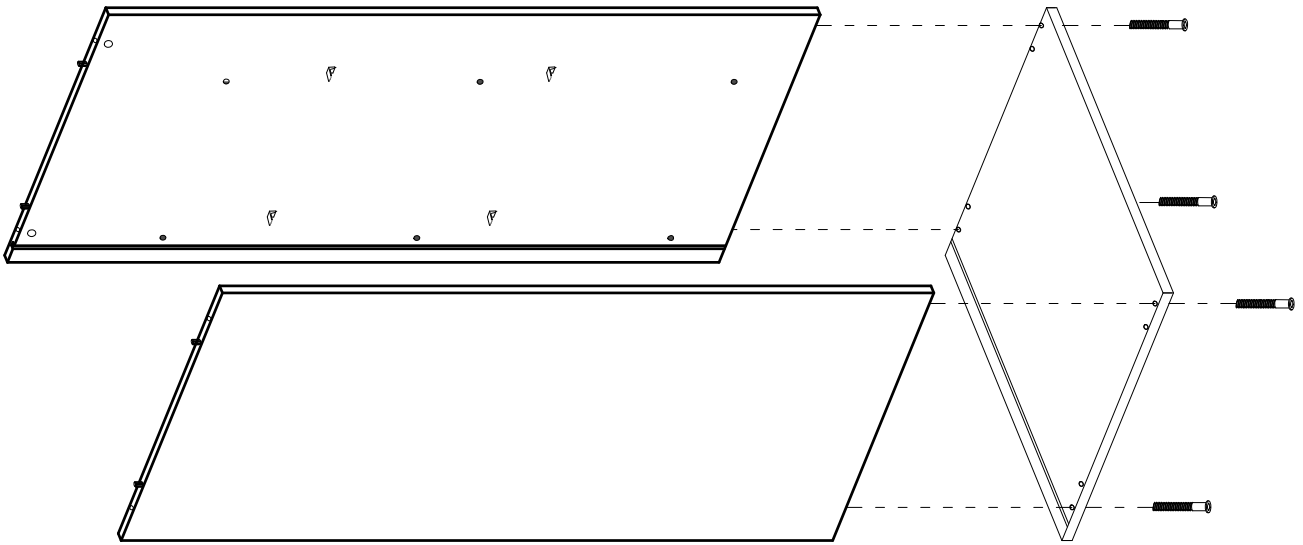
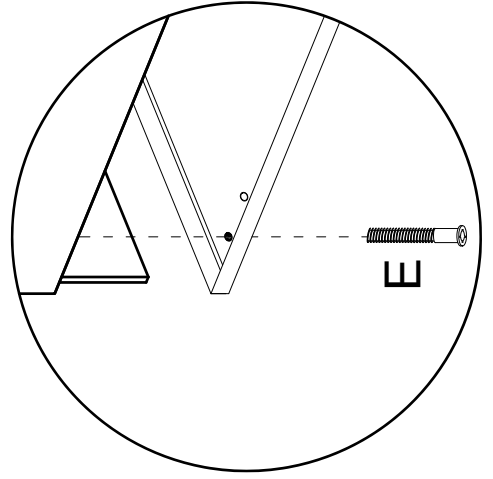
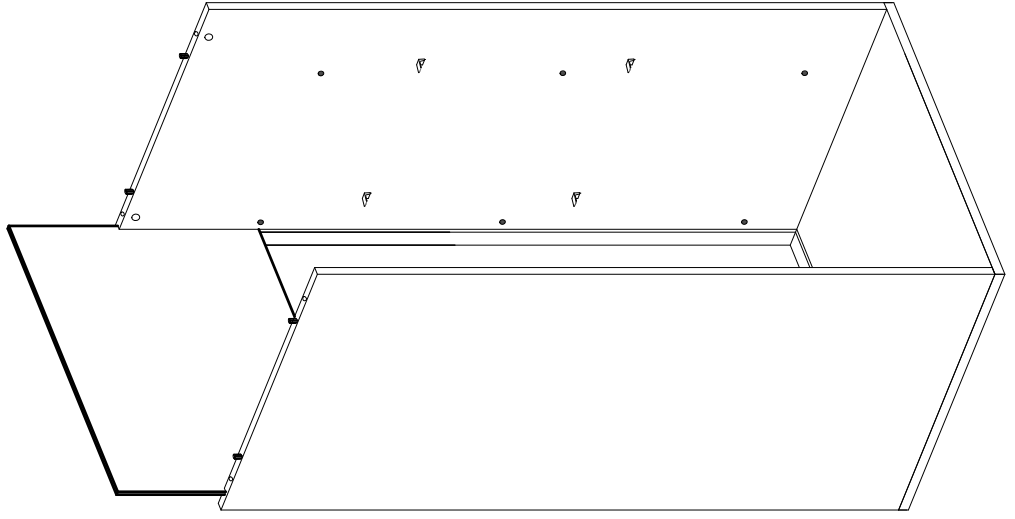
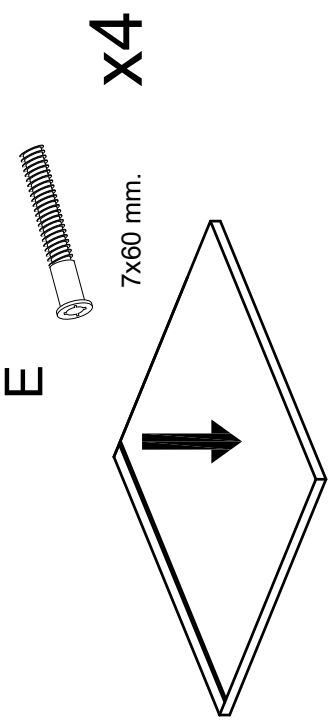

4

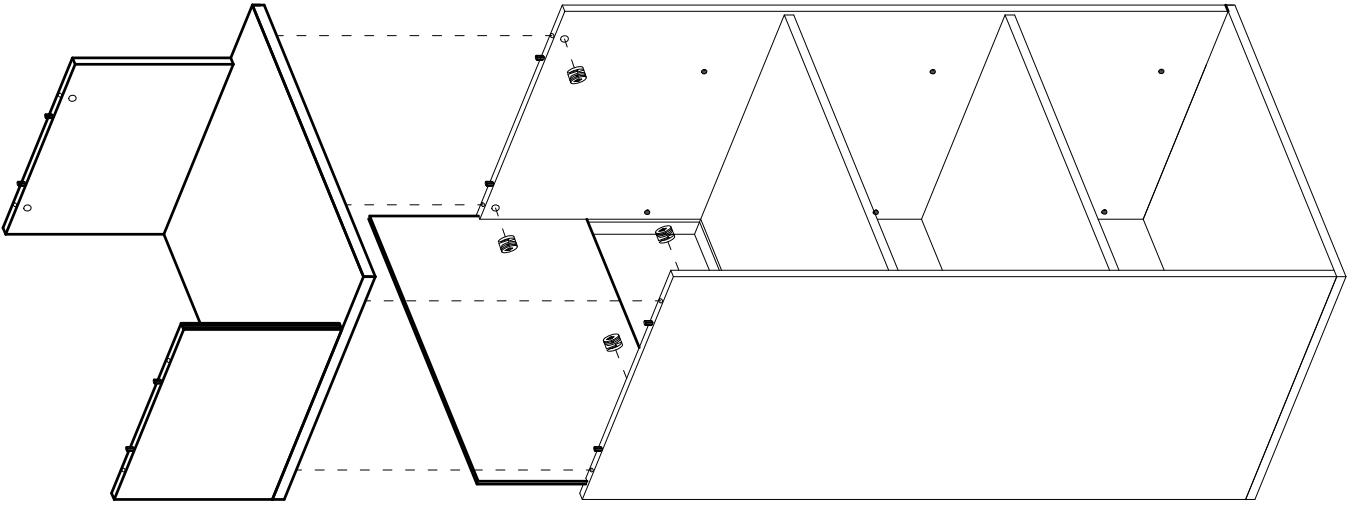
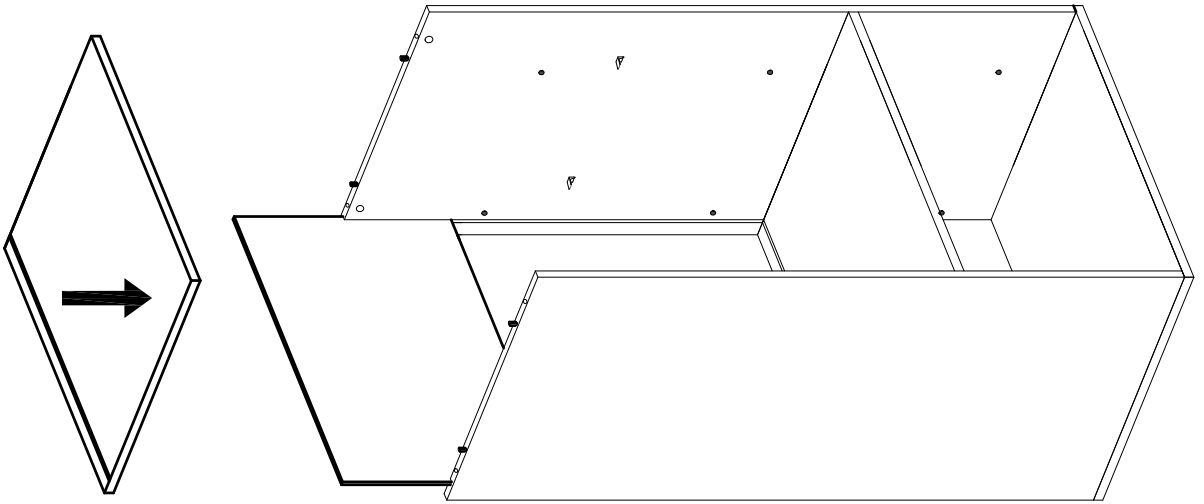

C

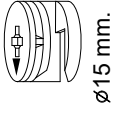

x4

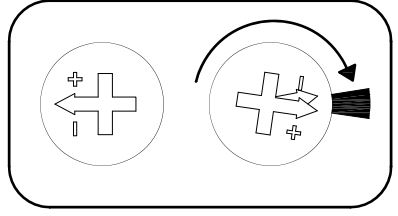
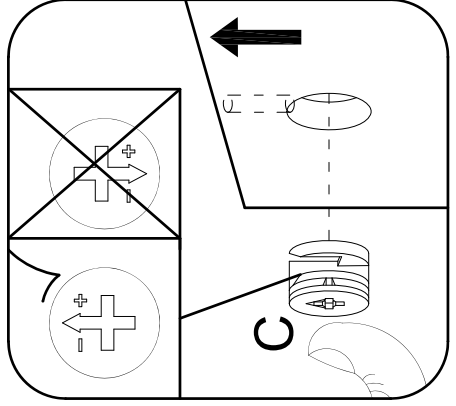

5

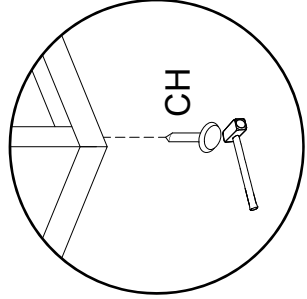
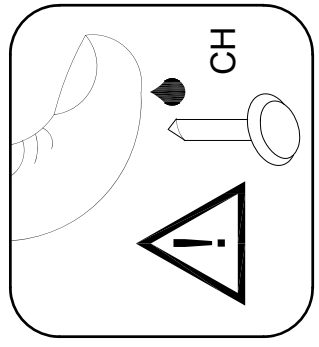
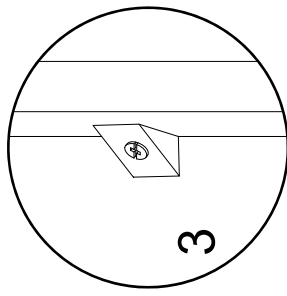
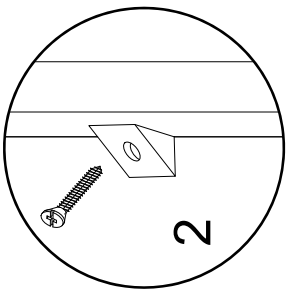
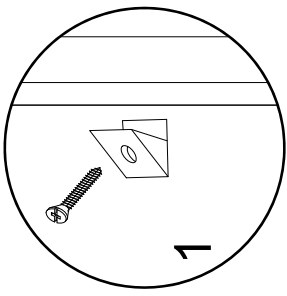
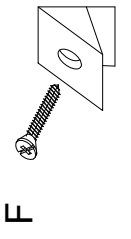
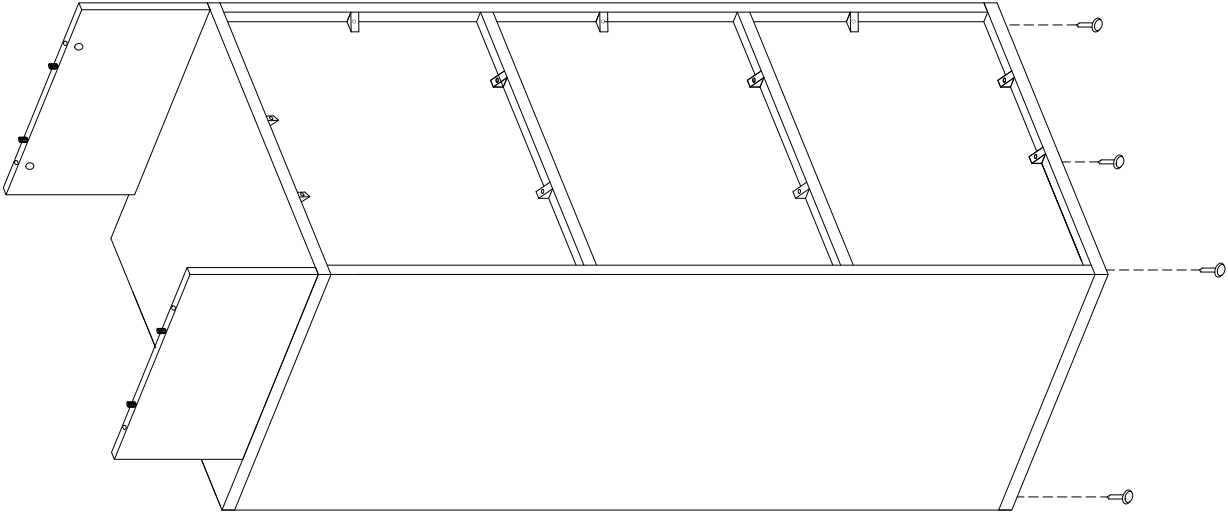
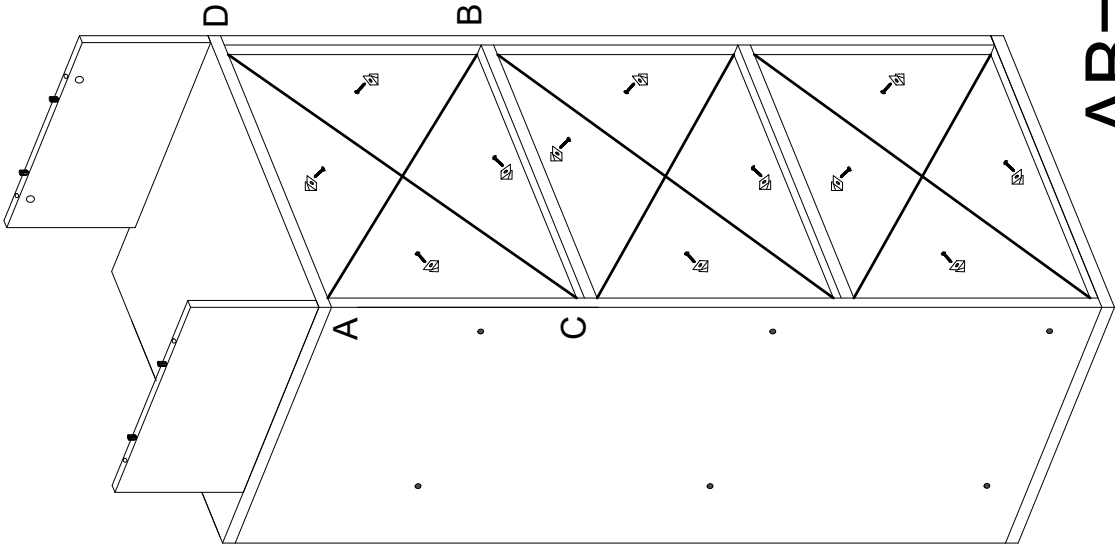

5

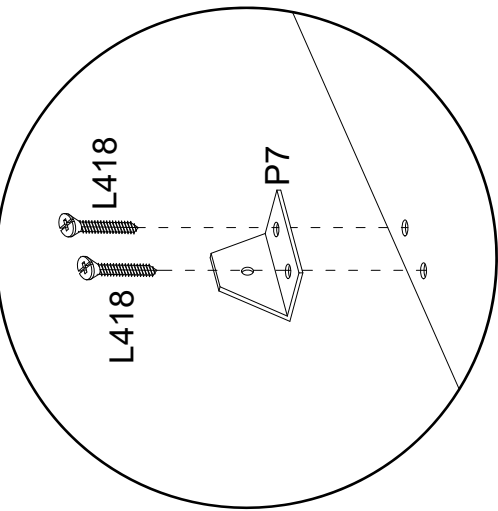

B

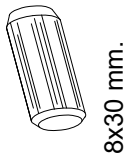

x8

P7

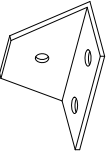

L418

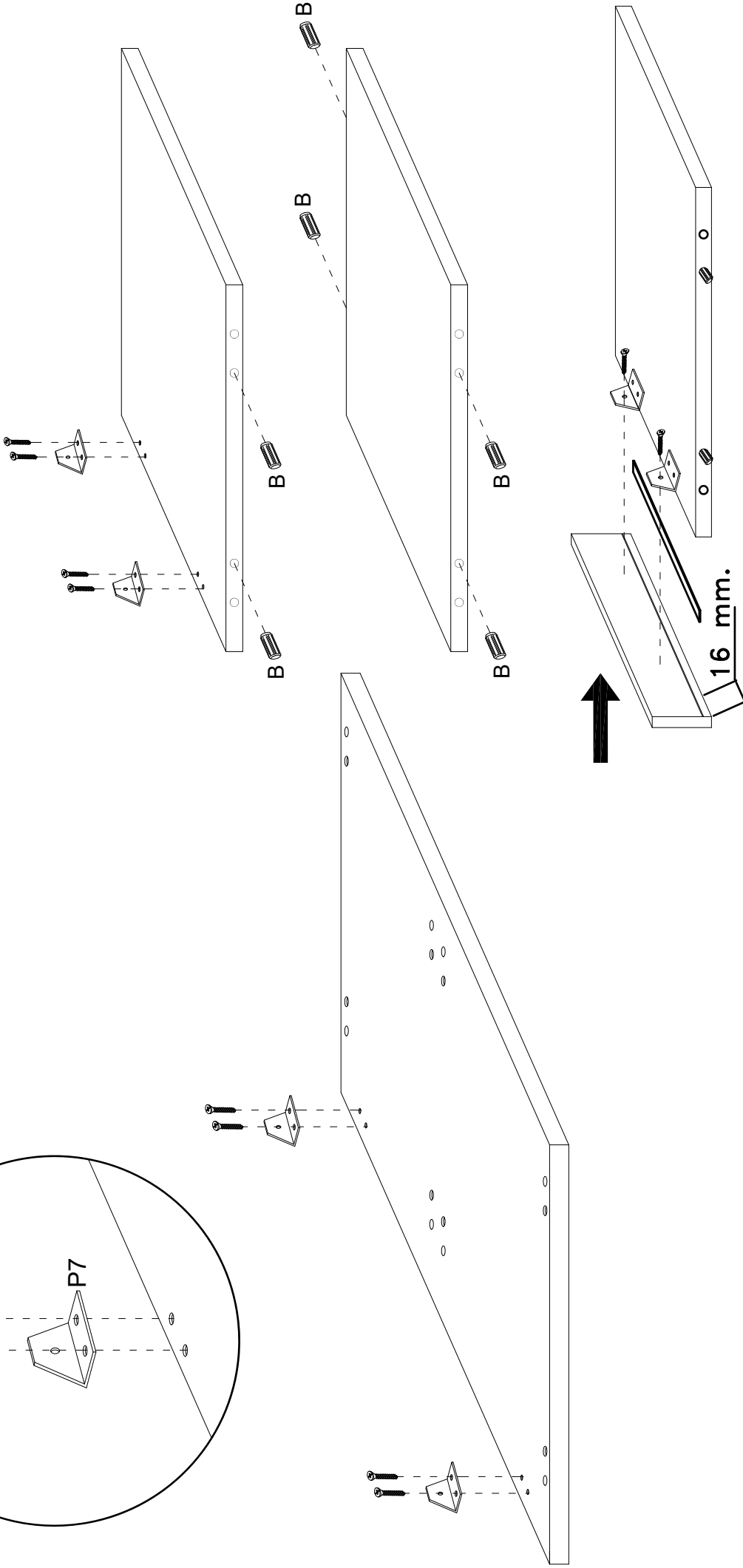

E



7x60 mm.

X6

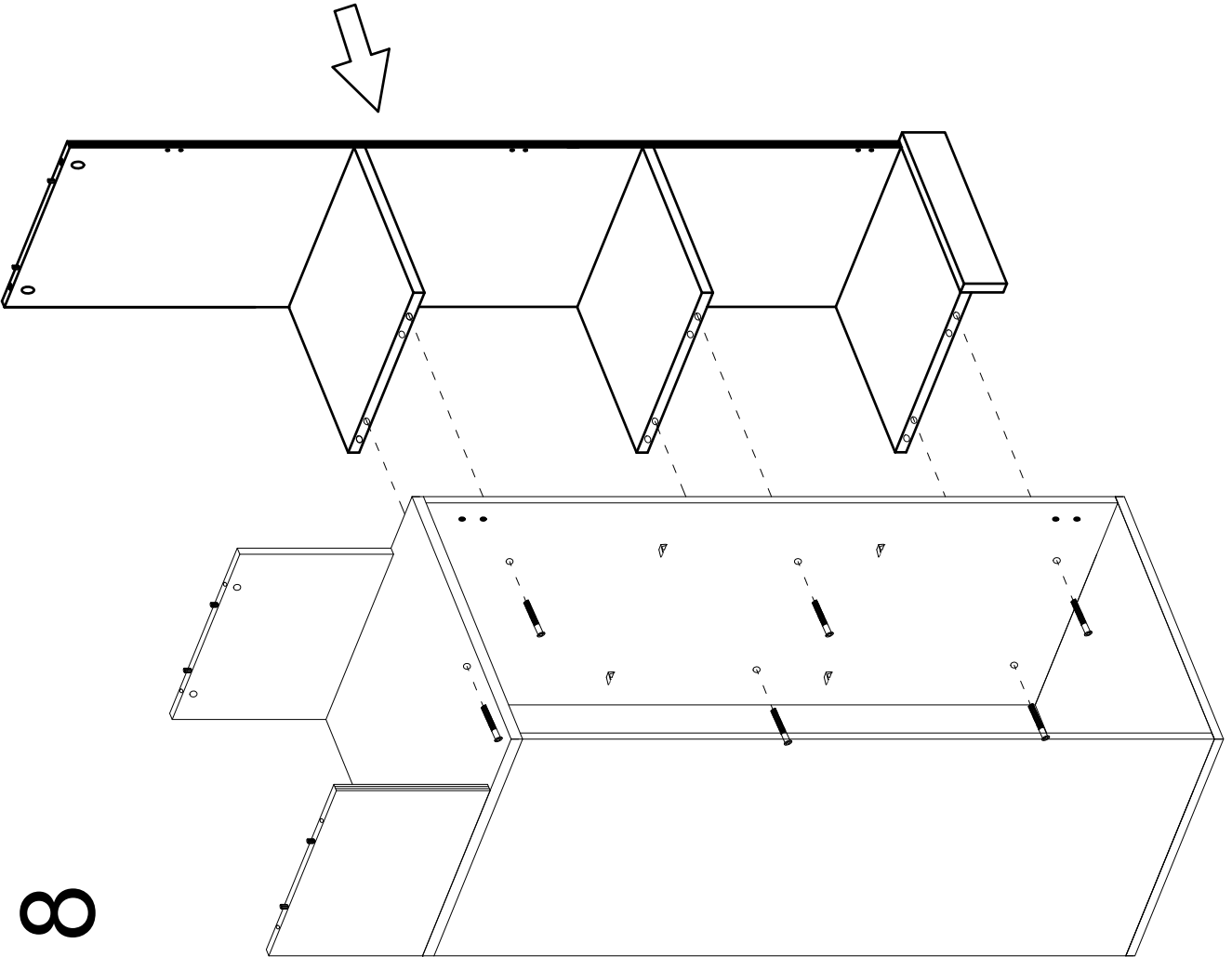

8

9

P7

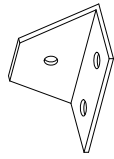

x4

L418

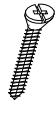

4x18 mm. x12

C



ø15 mm.

x6

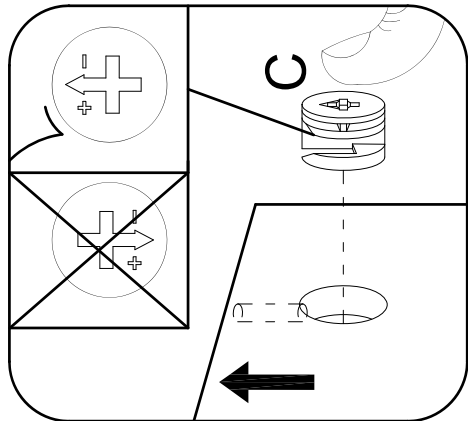
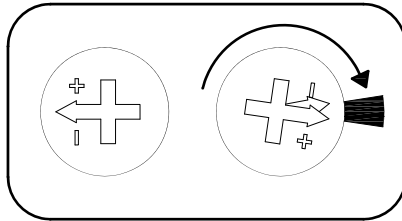
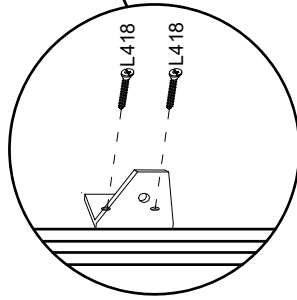
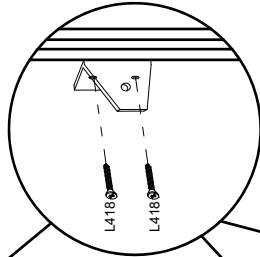
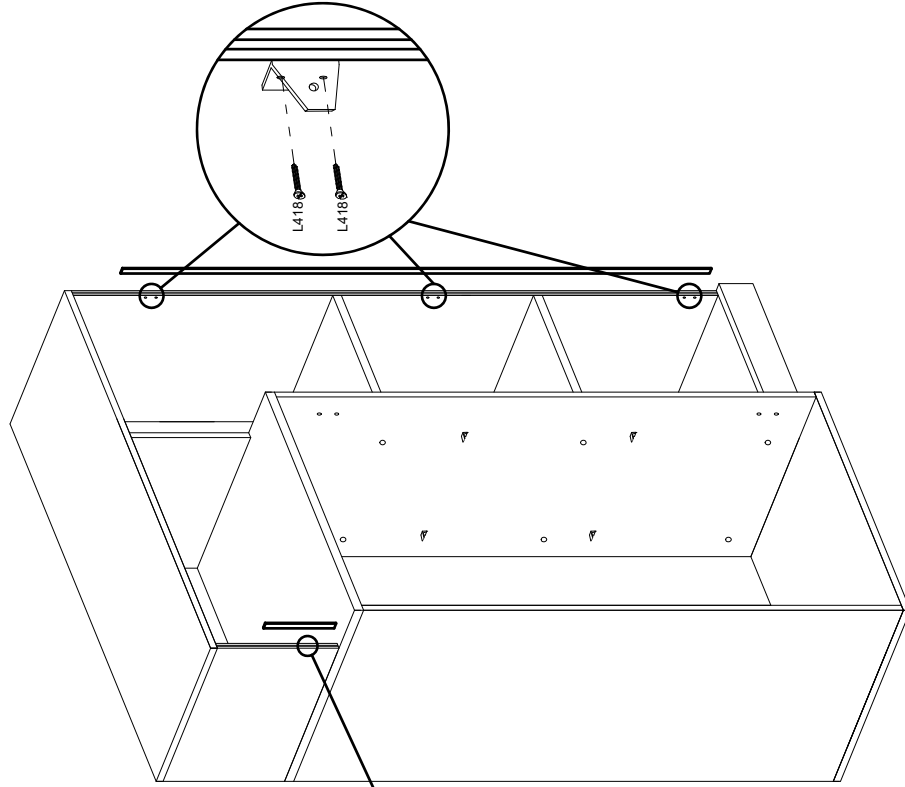
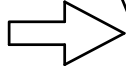

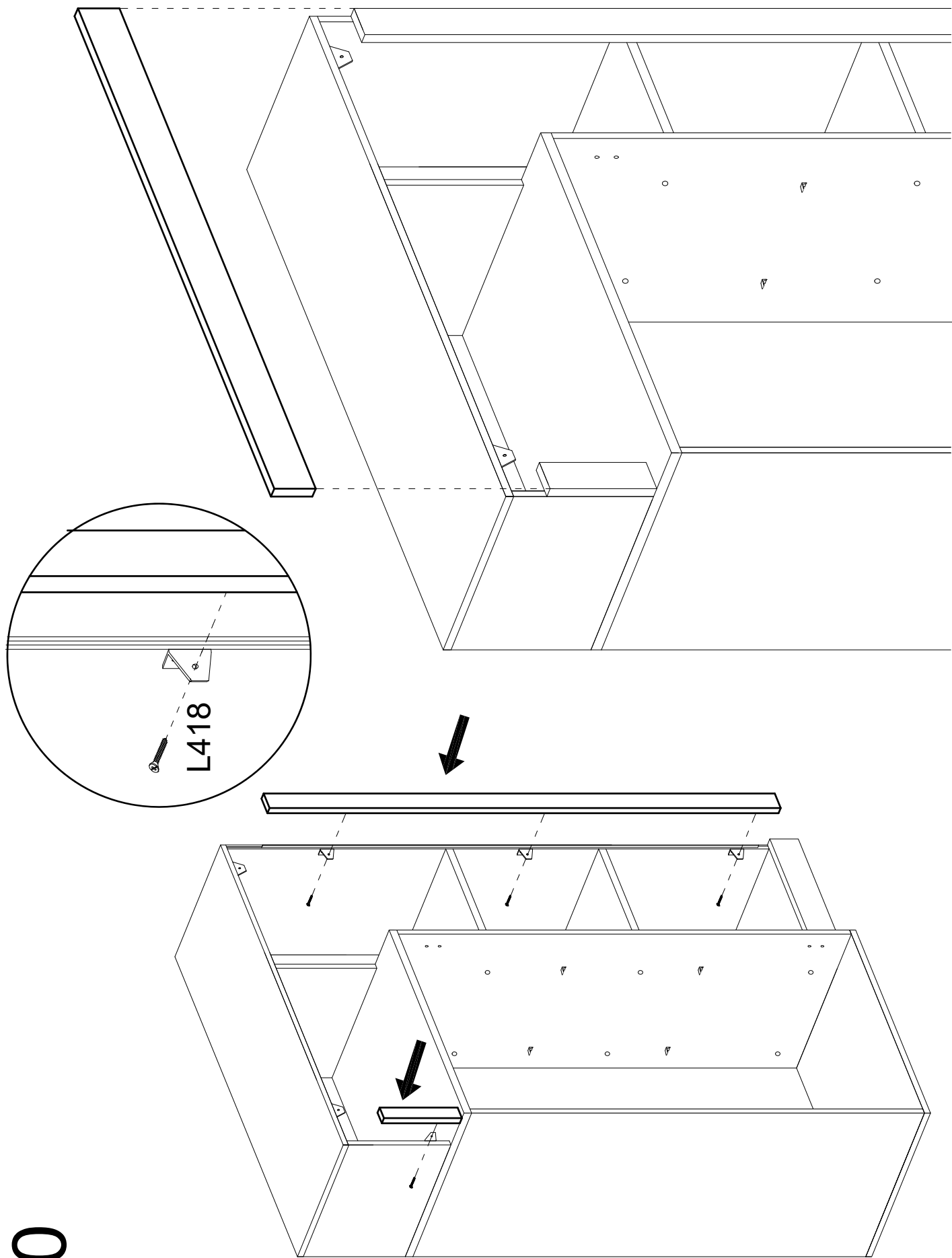

L418



x2

4x18 mm.

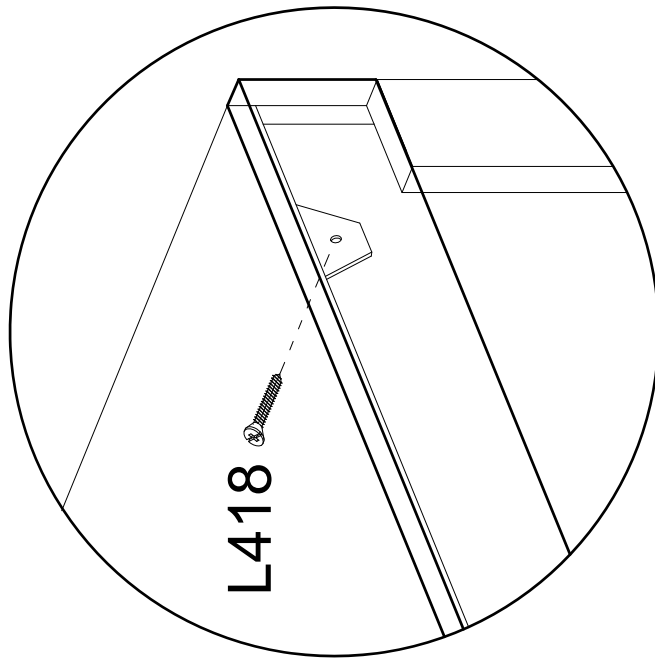
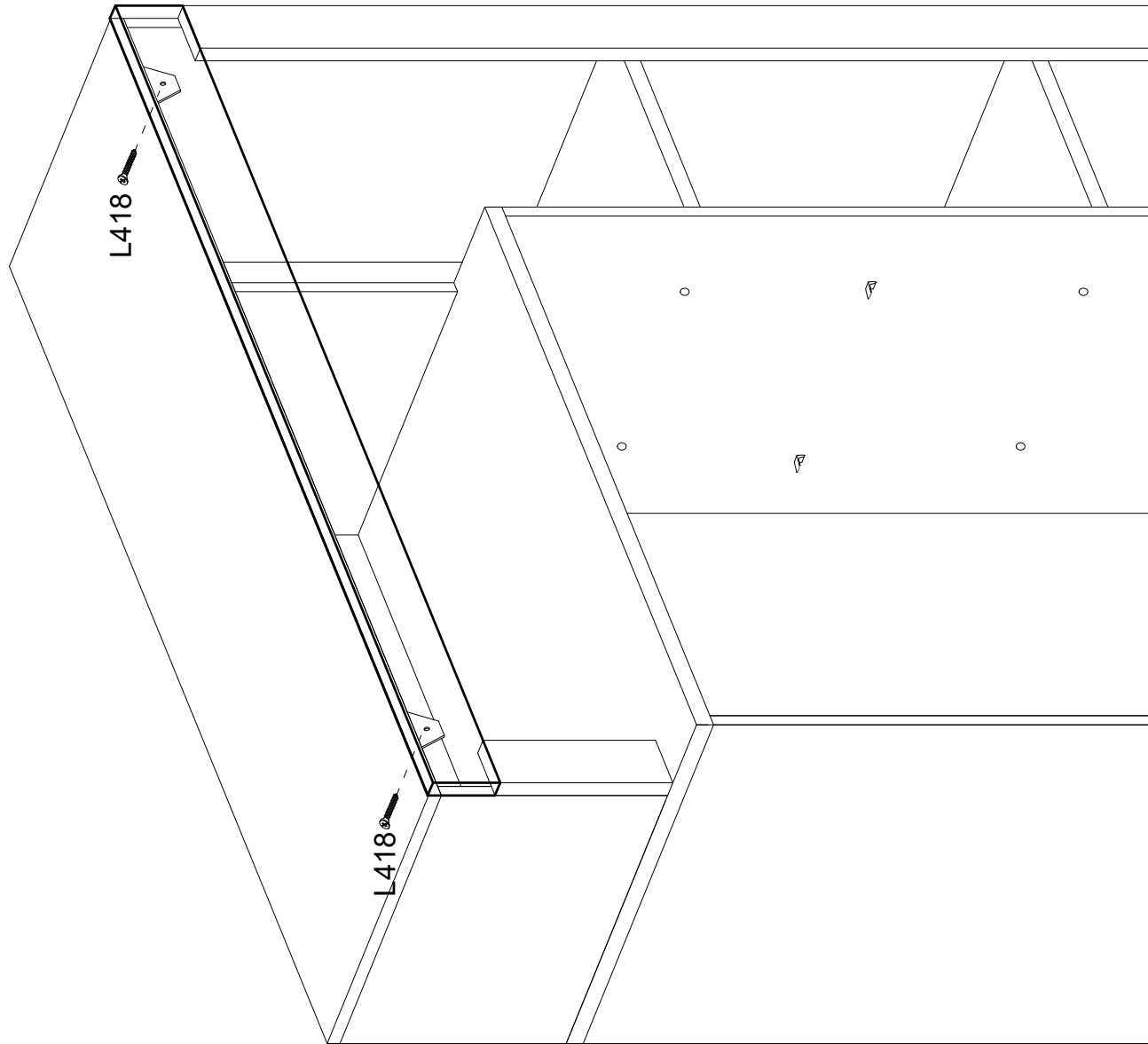

L416



4x16 mm.

X8

PST

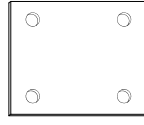

X2

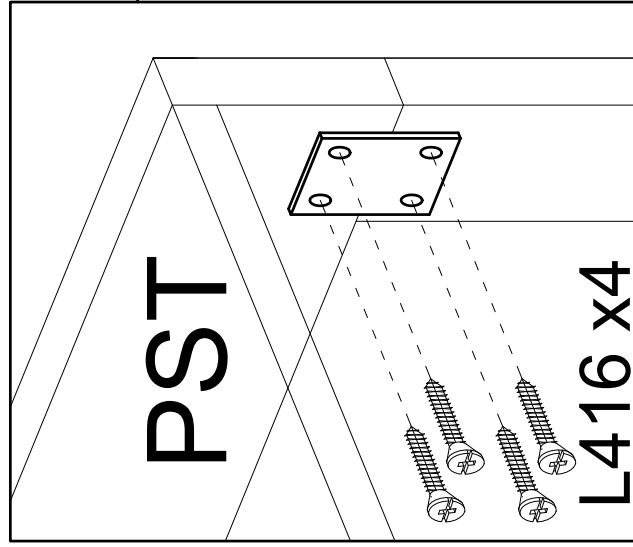
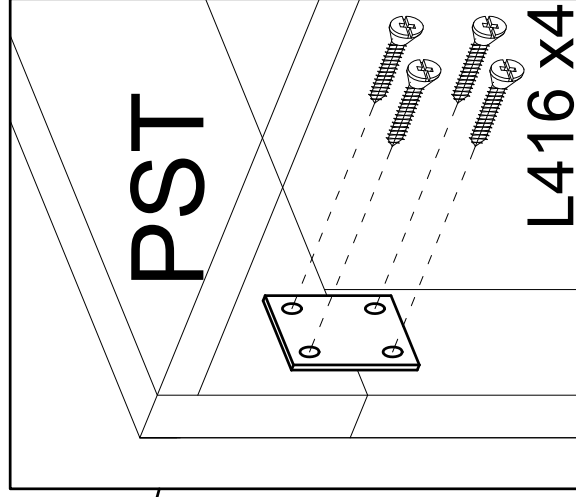
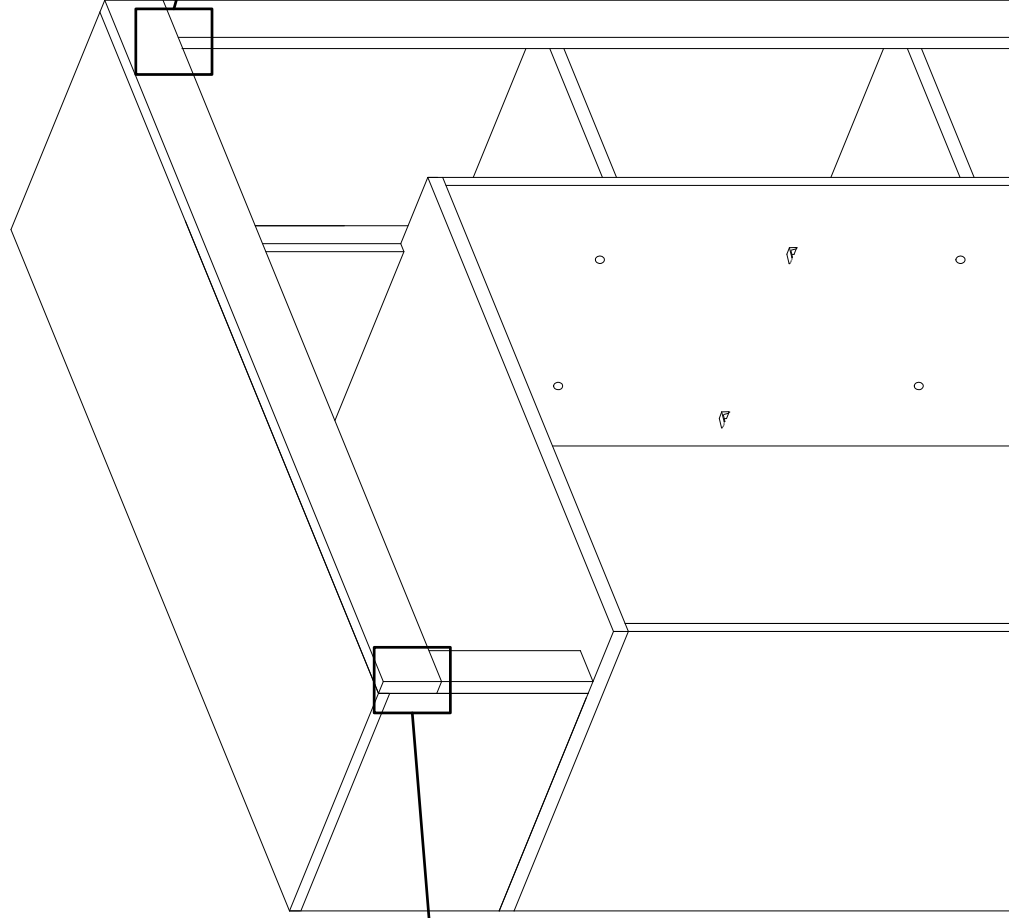

13

L15

x4



4x15 mm.

C0

x2

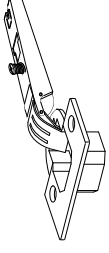

P

x2

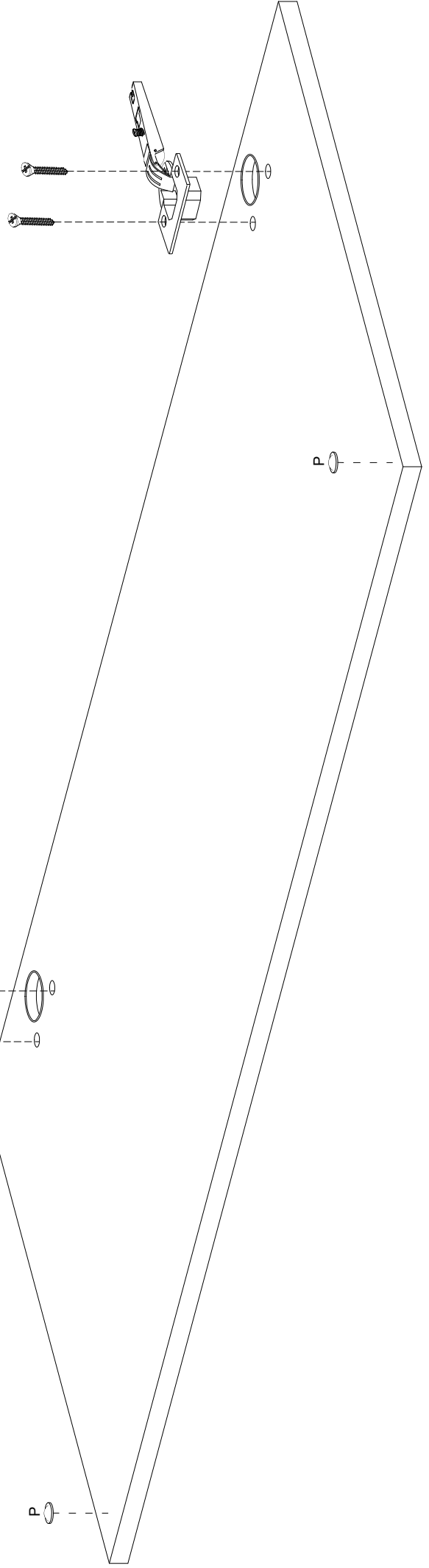
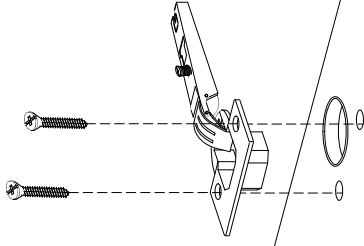
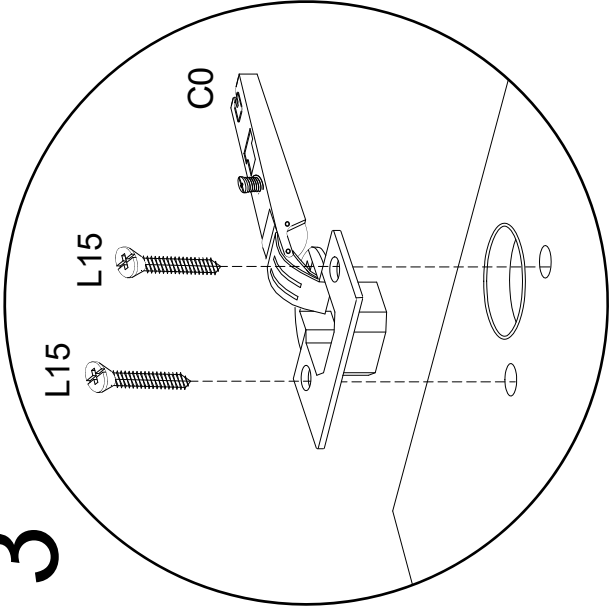

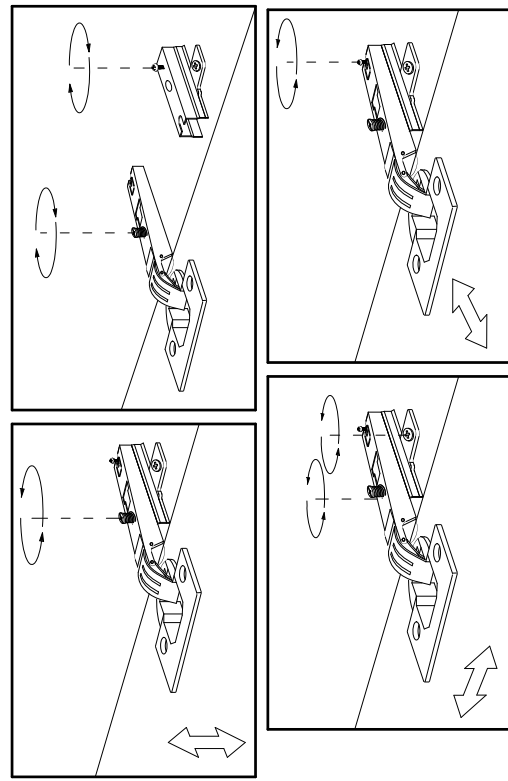
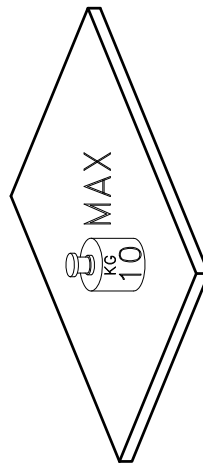
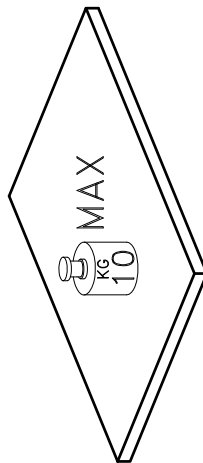
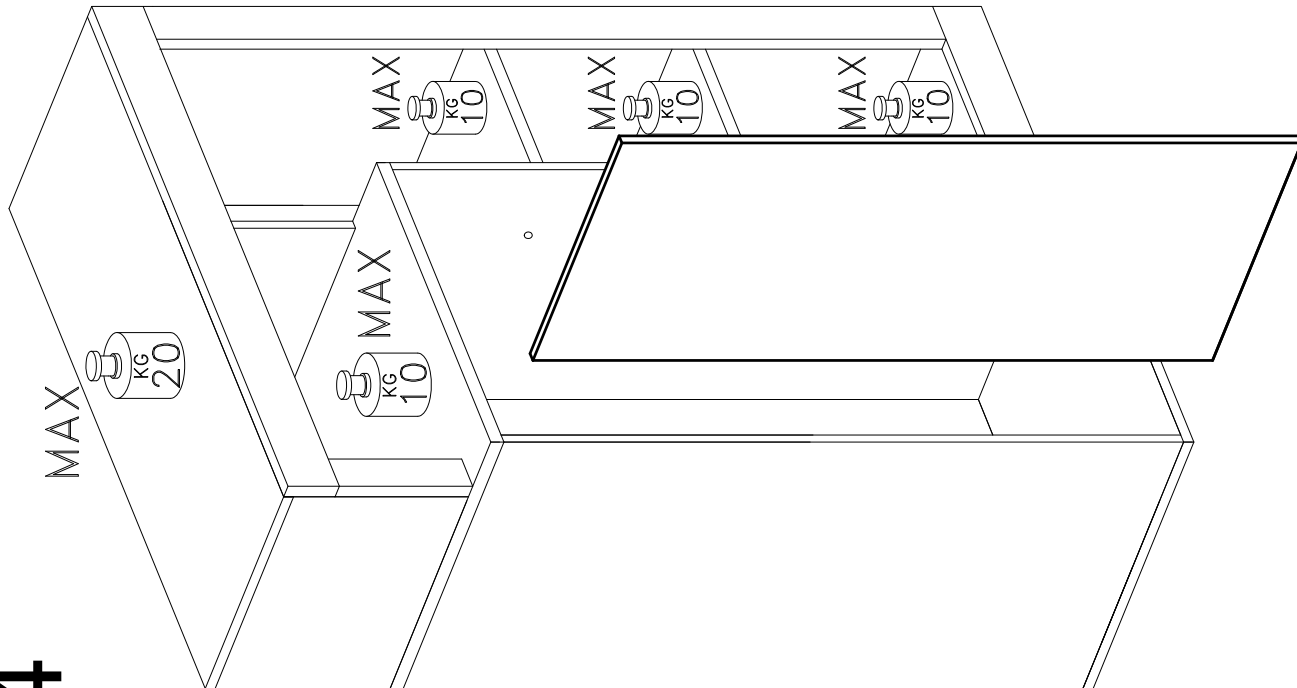

16

346 mm · 346 mm ·

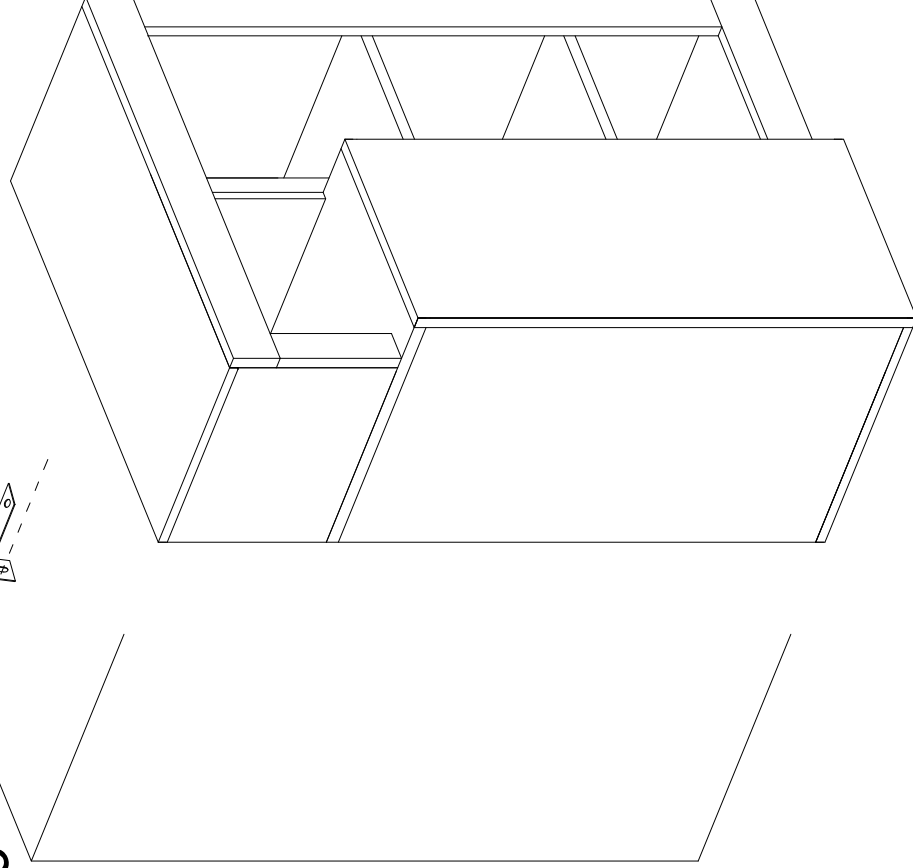

1230 mm.

Cher client,
l'installation des meubles suspendus doit être effectuée par un personnel compétent.

Les fishers ne sont pas inclus dans la quincaillerie.

Choisir les types des fishers pour le fixage apte au mur.

S'assurer de l'adéquation du mur pour support sûr du meuble

Dear Customer

The assembling of the hanging elements must be done by a competent staff.

The fishers are not included in the hardware package.

Choose the fisher more suitable to the type of the wall.

Ensure the suitability of the wall for a secure support of the hanging element.

Sehr geehrter Kunde, die Montage der Haengeelemente muss von Fachpersonal ausgefuehrt werden! Bitte verwenden Sie eigene, der Beschaffenheit der Wand entsprechende Duebel. Zu Ihrer eigenen Sicherheit legen wir dem Beschlagbeutel keine Fischerduebel bei.

Gentile Cliente

Il montaggio dei pensili deve essere effettuato da personale competente.

I tasselli di fissaggio non sono compresi nella ferramenta.

Scegliere il tipo di tassello per il fissaggio più adatto alla tipologia di muro.

Assicurarsi l'idoneità della parete per un sostegno sicuro del pensile.

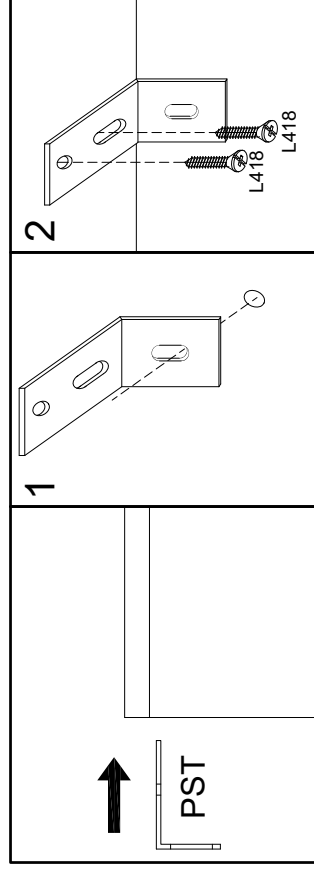

4x18 mm.

L418 x2 PST x1