

## Lotus

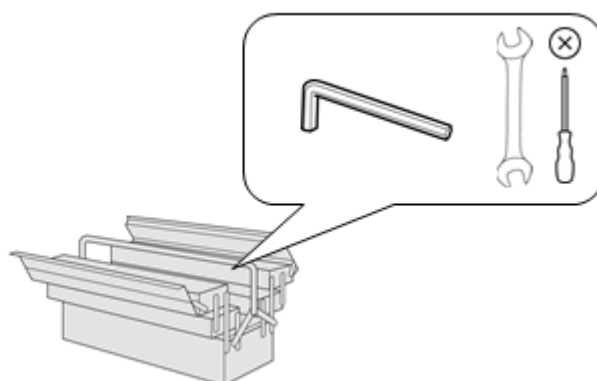

- |                                  |                                       |
|----------------------------------|---------------------------------------|
| <b>D</b> Montageanleitung        | <b>GB</b> Assembly instructions       |
| <b>FR</b> Notice de montage      | <b>NL</b> Handleiding voor de montage |
| <b>CZ</b> Montážní návod         | <b>IT</b> Istruzioni di montaggio     |
| <b>RO</b> Instrucțiuni de montaj | <b>RU</b> инструкция по сборке        |
| <b>PL</b> Instrukcja montażu     | <b>SK</b> Návod na montáž             |
| <b>HU</b> Szerelési útmutató     | <b>TR</b> Montaj talimatı             |

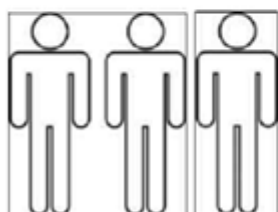

0  
10  
20  
30  
40  
50  
60  
70  
80  
90  
100  
110  
120  
130  
140  
150  
160  
170  
180  
190  
200

<b>Service • Assistenza • Dienstverlening • Serwis</b> <b>Servis • Szerviz • Сервисная служба</b>	
Name • Nom • Nome • Naam Nazwa • Jméno • Názov • Név Denumire • İsim • Название	<b>Lotus zerl.</b>
Nr. • No. • N° • Номер • Č • Sz	<b>SH55</b>
Typ • Type • Tip • Típus • Тип	<b>LARO</b>

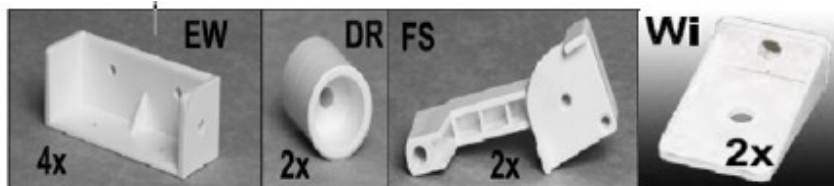
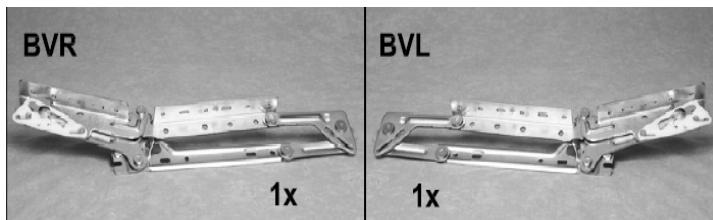
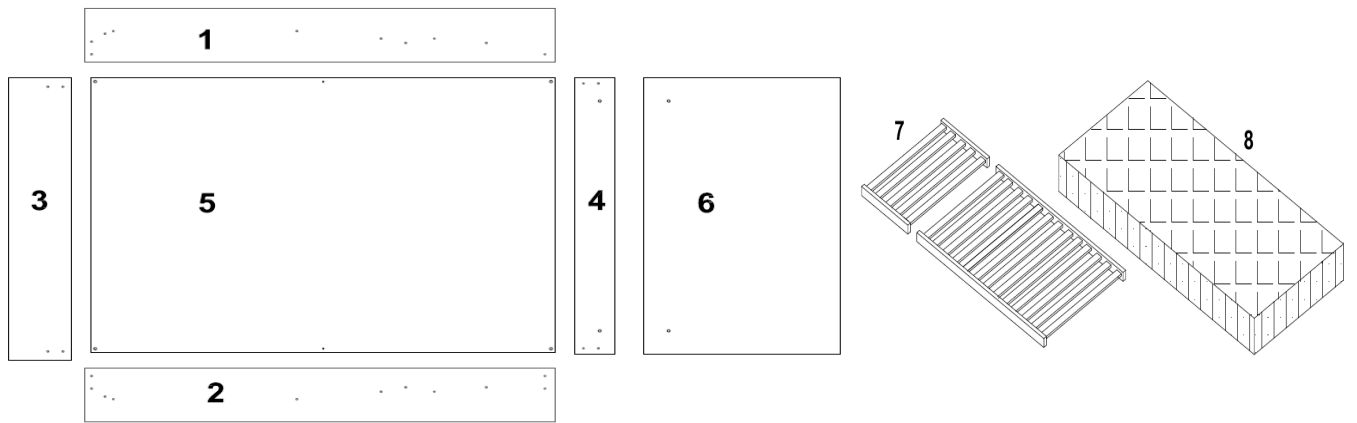

A	B	C	D	E	F	G	H	I	J	K	L	M	N	O
2x	20x 4,5x20	2x 6x35	2x 6x45	2x 4,5x45	2x 6x30	2x M8	2x M5	2x M5	2x 4,5x20	2x	2x 8x45	6x 8x20	6x M8	4x 8x60

1.

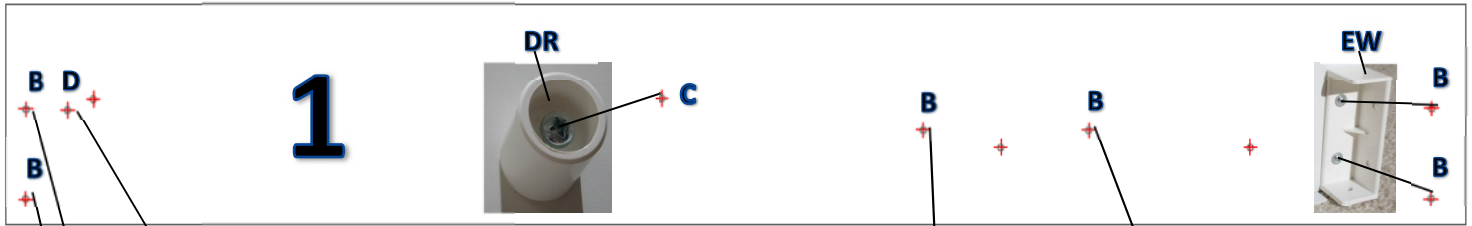

Handfest anziehen  
 Ne serrez pas  
 Nedotahujte  
 Nu strângeți  
 Nie dokrećac  
 Ne húzza meg  
 Do not tighten  
 Nog niet vastdraaien  
 Non serrare  
 Не затягивайте  
 Nedotahujte  
 Sıkmayın

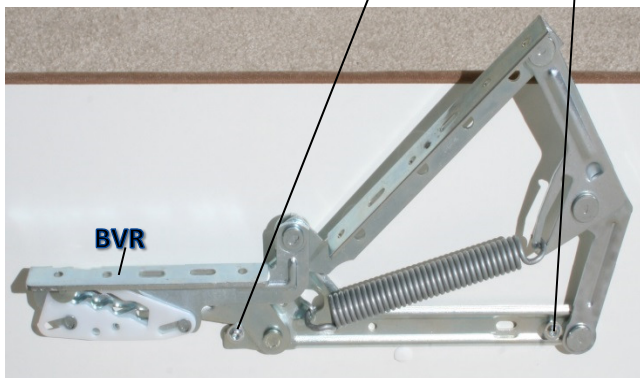
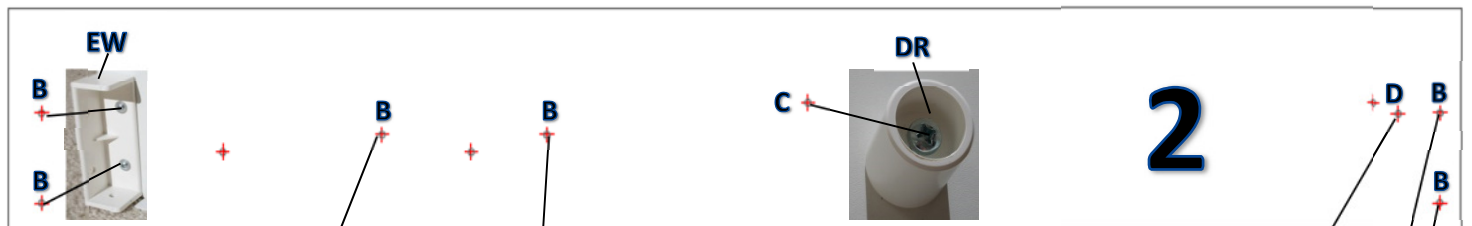
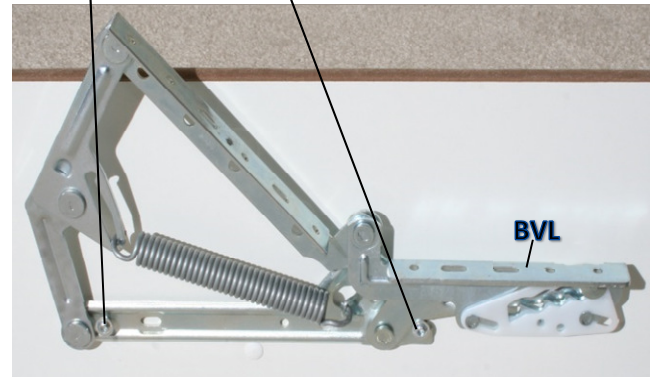

Handfest anziehen  
 Ne serrez pas  
 Nedotahujte  
 Nu strângeți  
 Nie dokrećac  
 Ne húzza meg  
 Do not tighten  
 Nog niet vastdraaien  
 Non serrare  
 Не затягивайте  
 Nedotahujte  
 Sıkmayın





2.



Schrauben fest anziehen  
 Serrer les vis  
 Utáhněte šrouby  
 Strângeți șuruburile  
 Dokrećić šrubby  
 Húzza meg a csavarokat  
 Tighten the screws  
 Draai de schroeven  
 Serrare le viti  
 Затянуть винты  
 Utiahnite skrutky  
 Vidaları sıkın

3.





4.

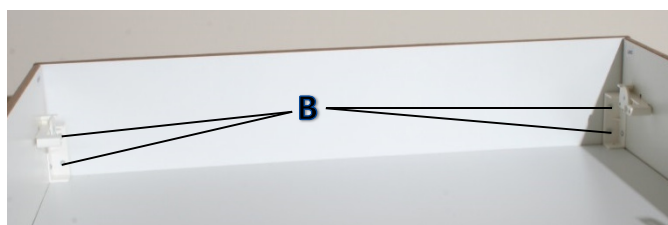
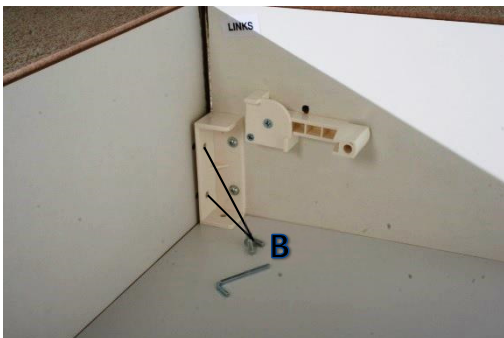

5.



6.

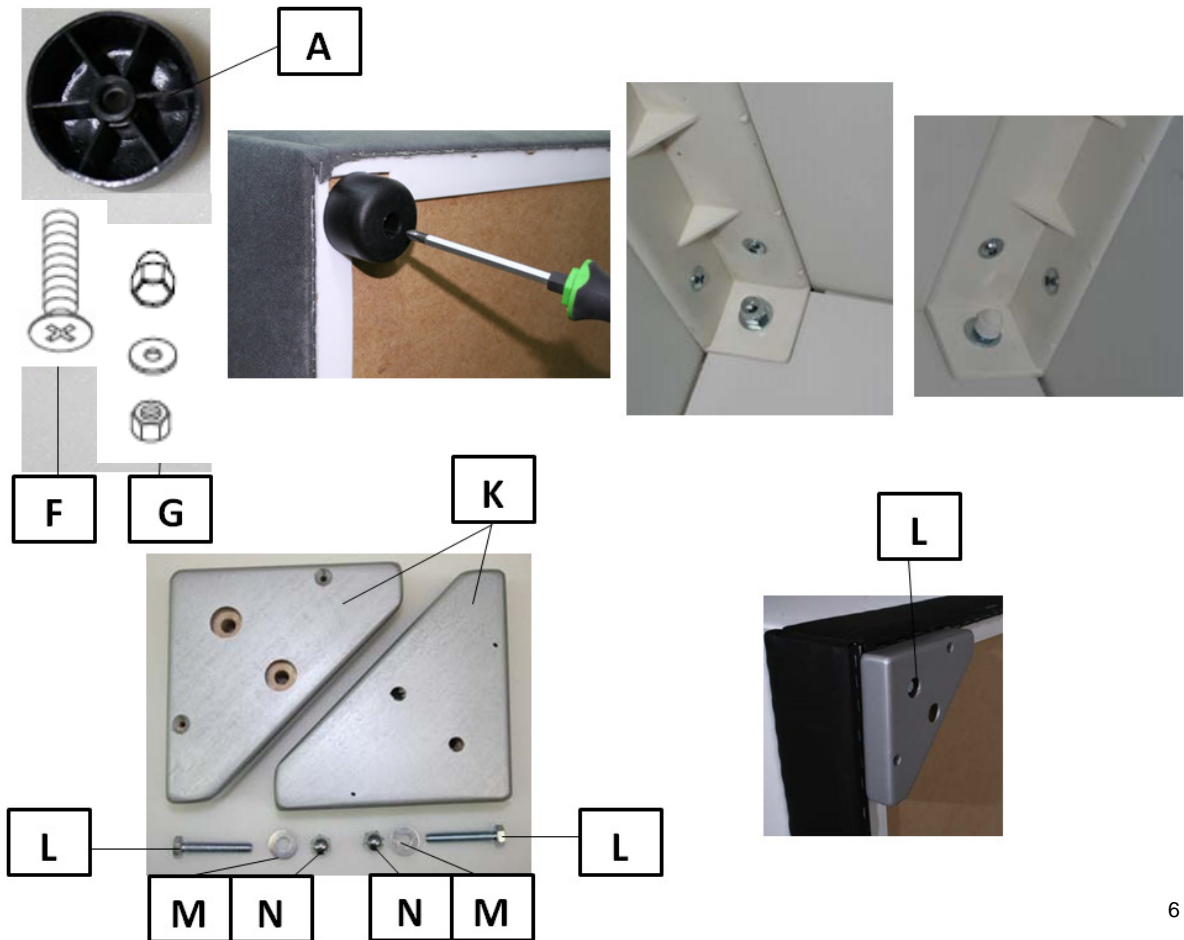





7.



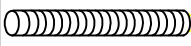

M		4x 8x60
N		4x M8
O		4x M8

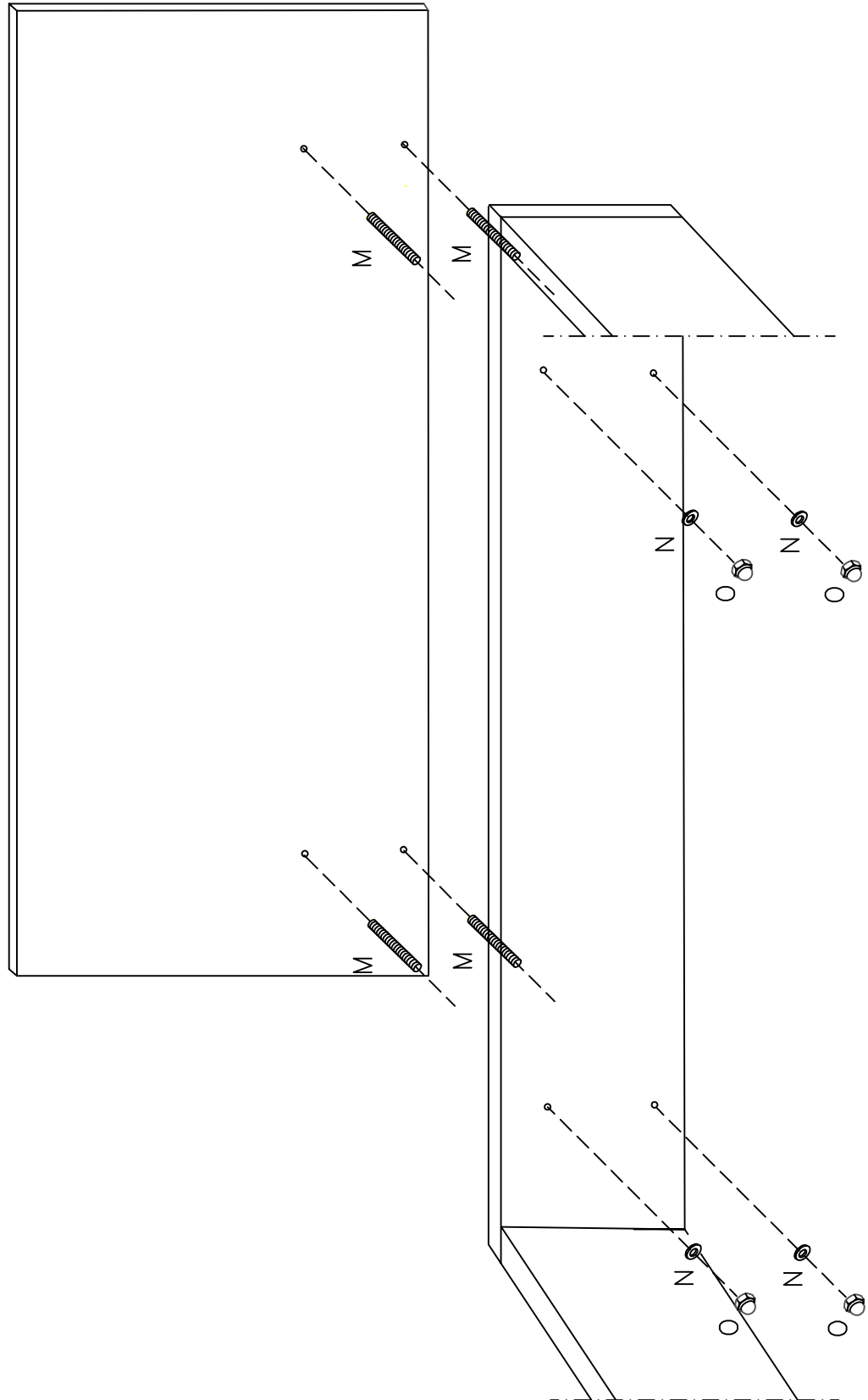

KT\_4xGEW\_8x60