

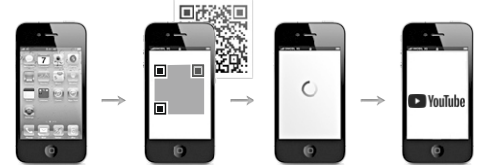

- (D) Videounterstützte Montageanleitung
- (TR) Video destekli kurulum talimatları
- (RU) инструкция по монтажу с помощью видеосигнала
- (RO) Instrucțiuni de instalare acceptate video
- (GB) Video-assisted assembly instructions
- (IT) Istruzioni di montaggio video-assistite
- (CZ) Instalační pokyny podporované videem
- (PL) Instrukcje montażu wspomagane sygnałem wizyjnym
- (FR) Instructions de montage assistées par vidéo
- (NL) Video-ondersteunde montage-instructies
- (HU) Video-támogatott telepítési utasítások
- (SK) Inštalčné pokyny podporované videom

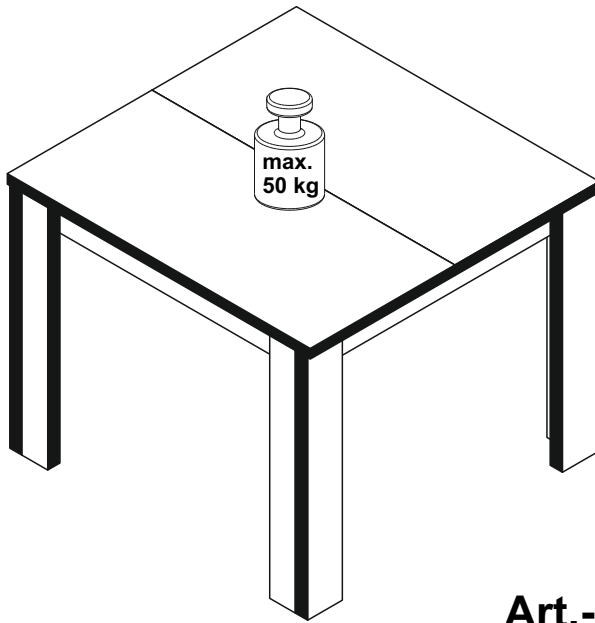

Art.-Nr.: **0567_80x80**
Esstisch

REPC-Nr.:

**Service • Assistenza • Dienstverlening • Serwis
Servis • Szerviz • Сервисная служба**



SCAN ME

Das Ersatzteil-Anforderungsformular finden Sie auf
The replacement parts requisition form you find on
<https://www.maeusbacher.de/ersatzteile/>

Beutel 0567_80x80 0-12 Colli 1/1

B01-80 28x 3,5x13		B01-122 24x 4x13		B02-167 4x		B02-211 8x		B02-212 8x	
B05-130 1x		B05-190 8x		B01-315 4x		B02-215 4x		B03-92 2x	



Beutel 0567_80x80 0-22 Colli 1/1

B01-10 4x		B01-140 32x		B05-20 8x		B02-10 8x		B02-20 8x	
--------------	--	----------------	--	--------------	--	--------------	--	--------------	--

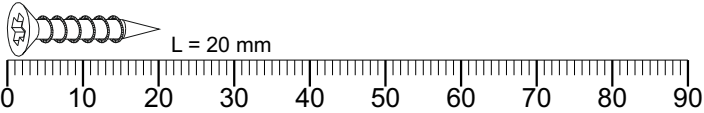

Colli 1/1

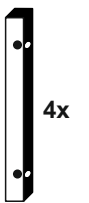

4x
728 x 71
Seitenteile

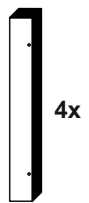

4x
728 x 90
VH-Teile

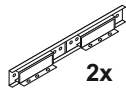

2x
Z05-35

Querstreben

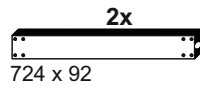

2x
724 x 92

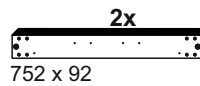

2x
752 x 92
Längsstreben

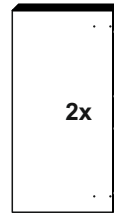

2x
800 x 400
Außenplatten

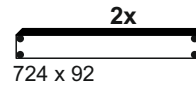

2x
724 x 92
Mittelleisten

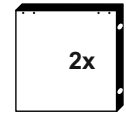

2x
400 x 400
Mittellplatte

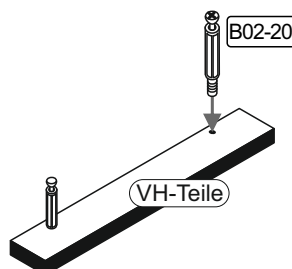
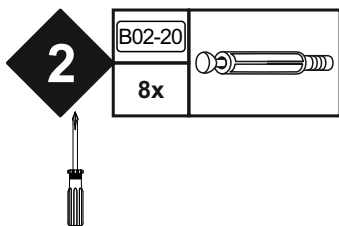
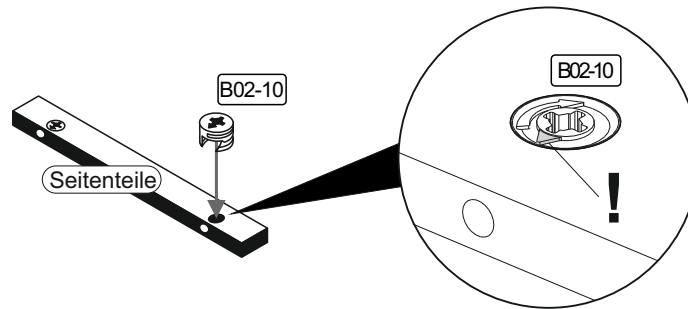
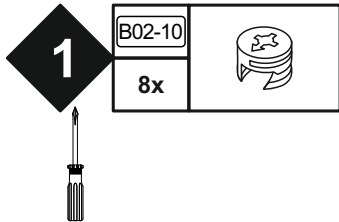



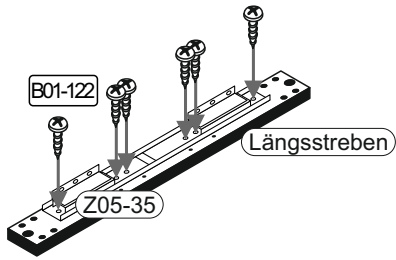

3	B01-122		4x13
	12x		

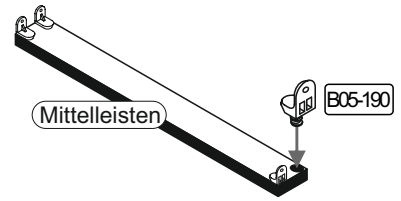

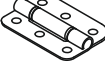



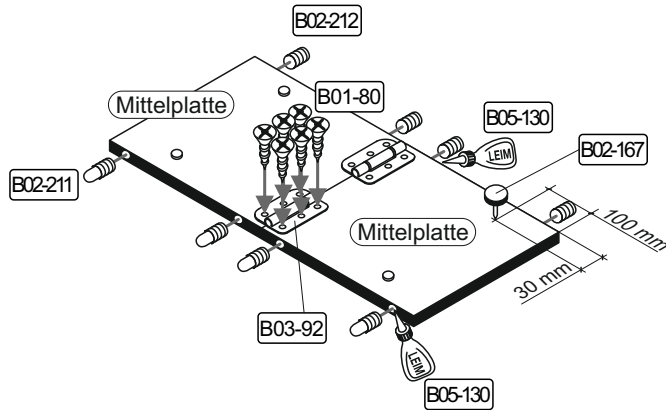
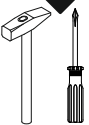

4	B05-190	
	8x	



5	B01-80		3,5x13	B03-92	
	12x			2x	
	B02-167		B02-211		
	4x		4x		
B02-212		B05-130			
4x		1x			



6	B01-80		3,5x13	B01-315	
	8x			4x	
	B02-211		B02-212		
	4x		4x		
	B02-215		LEIM		
	4x				
B05-130	1x				

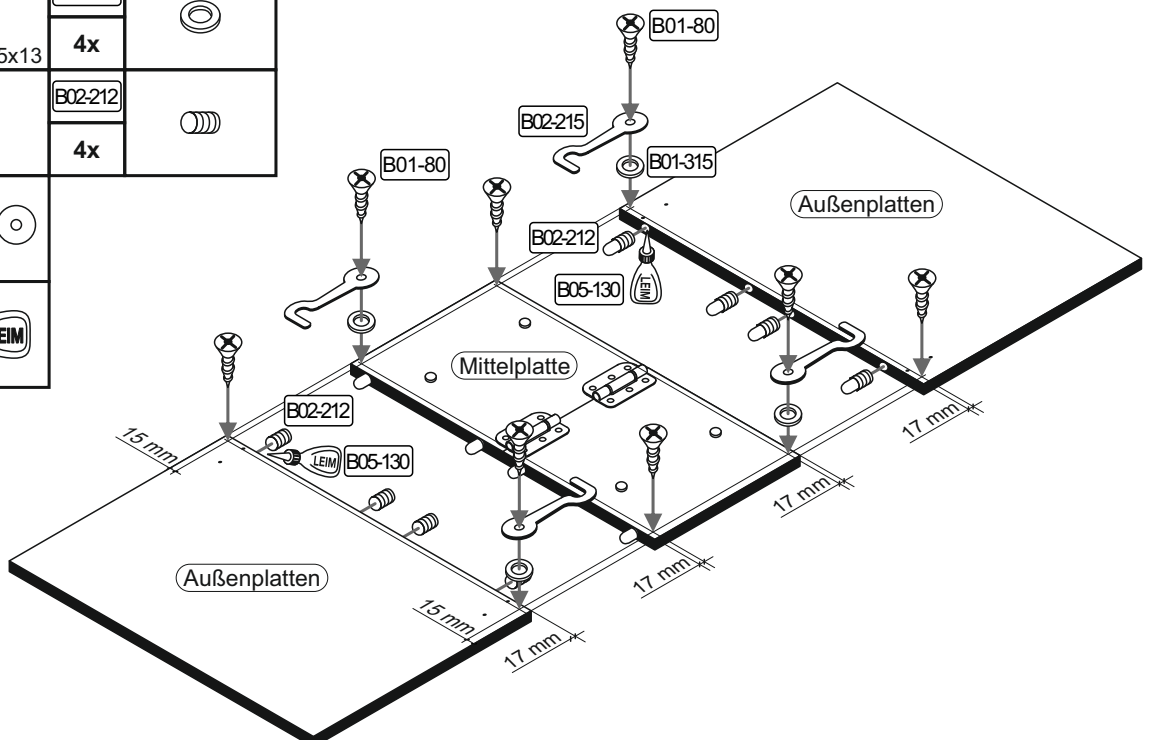
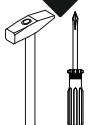

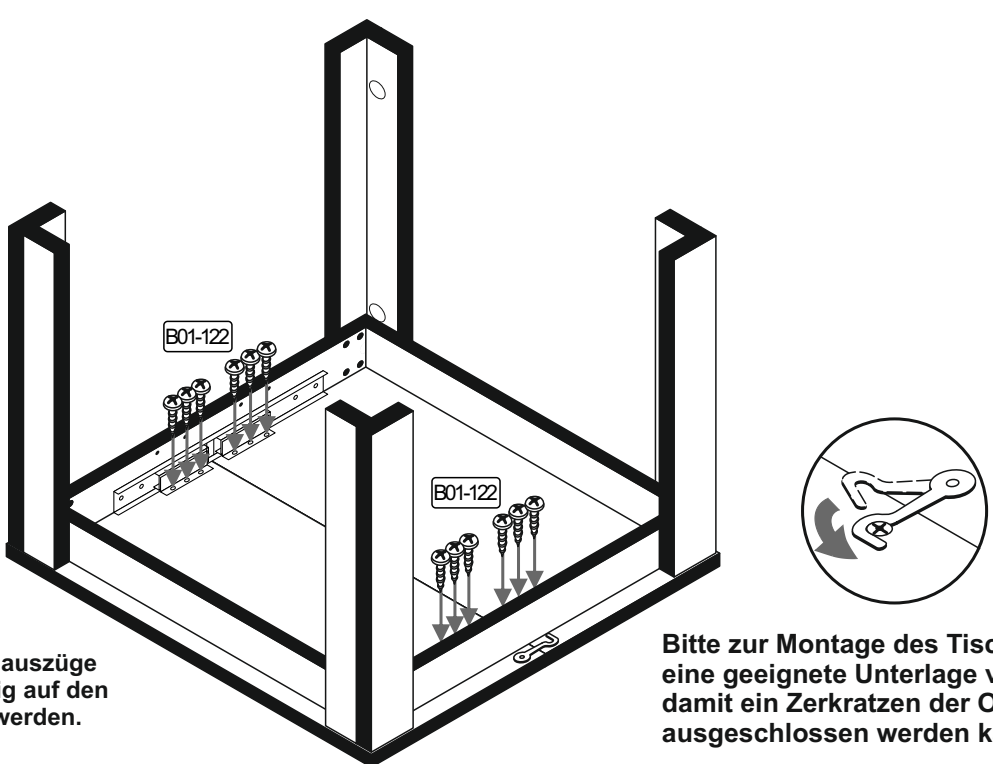
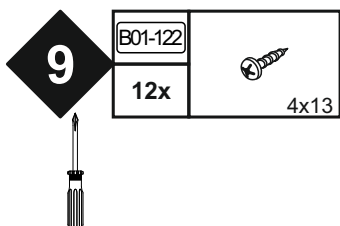
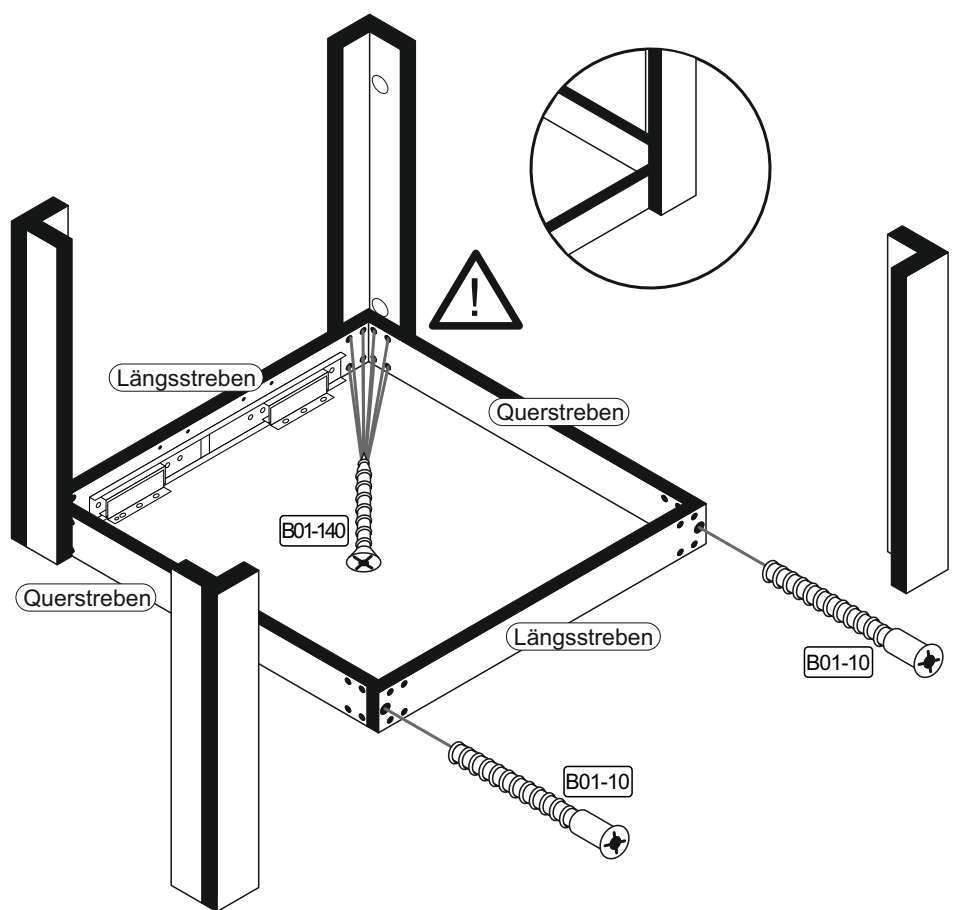
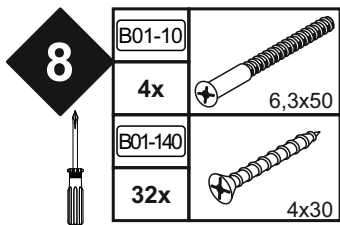
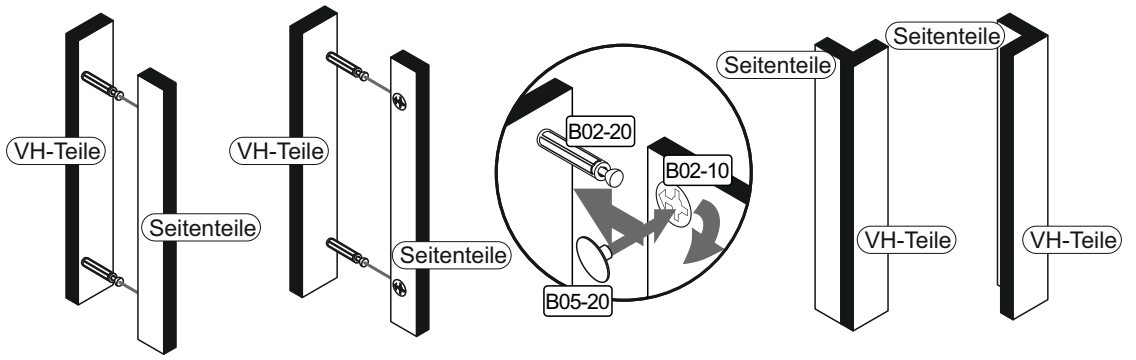
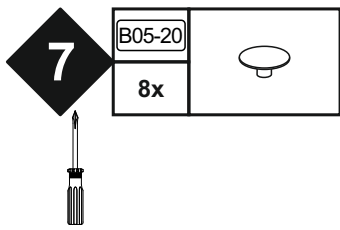



Vor der Montage der Tischauszüge muß das Untergestell mittig auf den Oberplatten ausgerichtet werden.

Bitte zur Montage des Tisches eine geeignete Unterlage verwenden, damit ein Zerkratzen der Oberplatte ausgeschlossen werden kann!

10

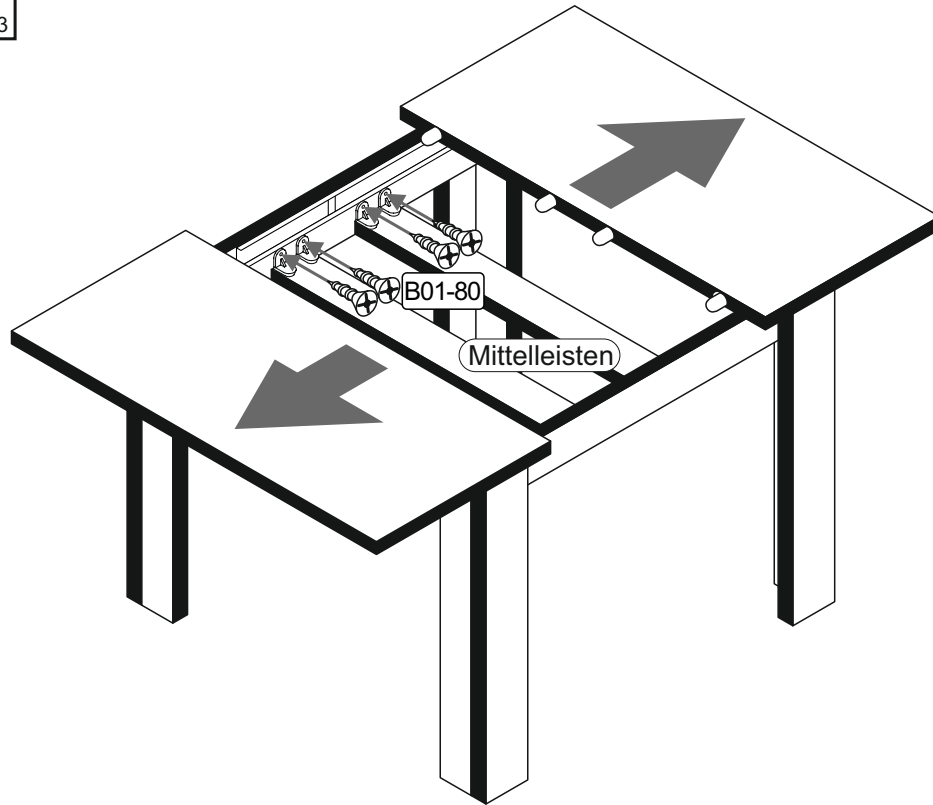
B01-80	
8x	3,5x13



11

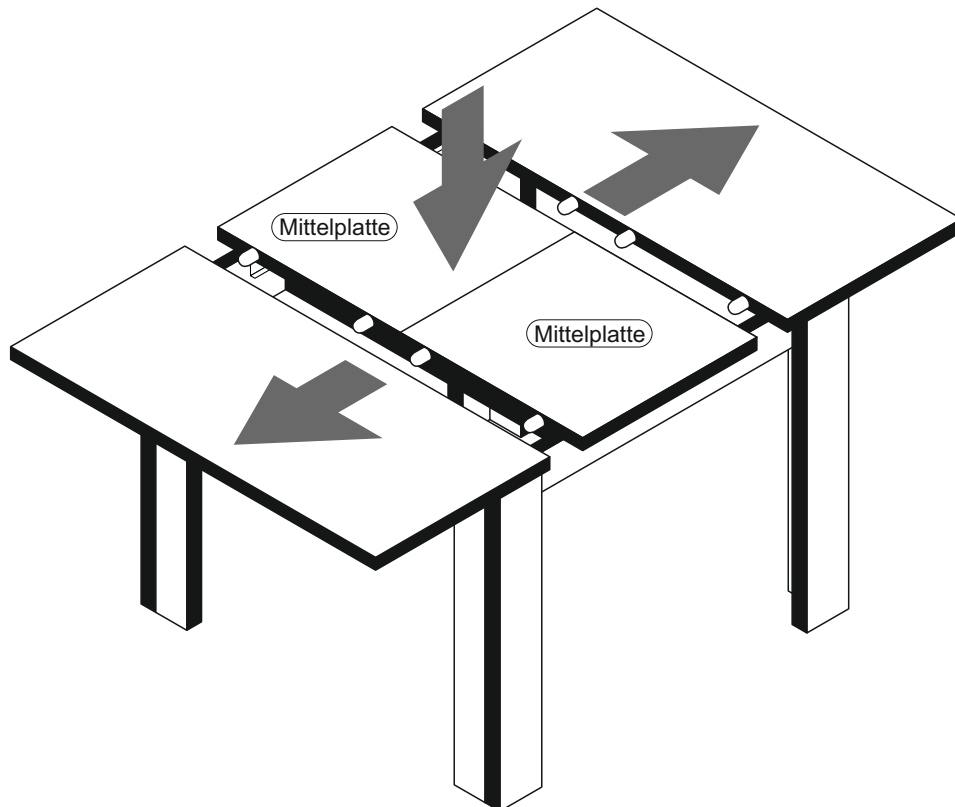

12

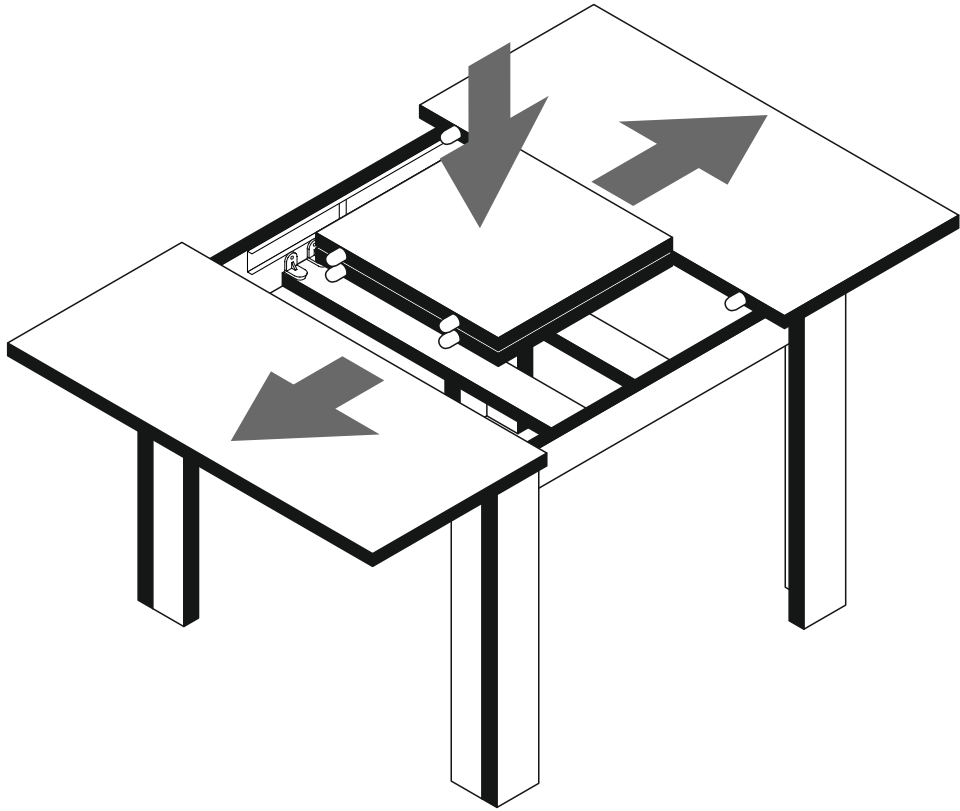

13

