

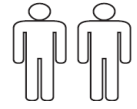

D - Montageanleitung GB - Assembly instructions NL - Handleiding voor de montage
 PL - Instrukcja montazu TR - Montaj talimatu RU - Инструкция по монтажу
 RO - Instructiuni de montaj IT - Istruzioni di montaggio FR - Notice de montage
 SK - Navod na monta CZ - Monta ni navod HU - Szerelési utmutató HR - Upute za montažu
 SI - Navodila za montažo BG - Инструкция за сглобяване



1/4

Name-Naam-Nazwa-Isim-Название-Nume-Nome-Nom-Názov-Název-Nev-Ime-Име

CALANDA 2AT.REC+H/REC.2AT+H



B1X5



B2X1



B3X2



A1X12



E1X12



1



2

2AT.REC+H

REC.2AT+H

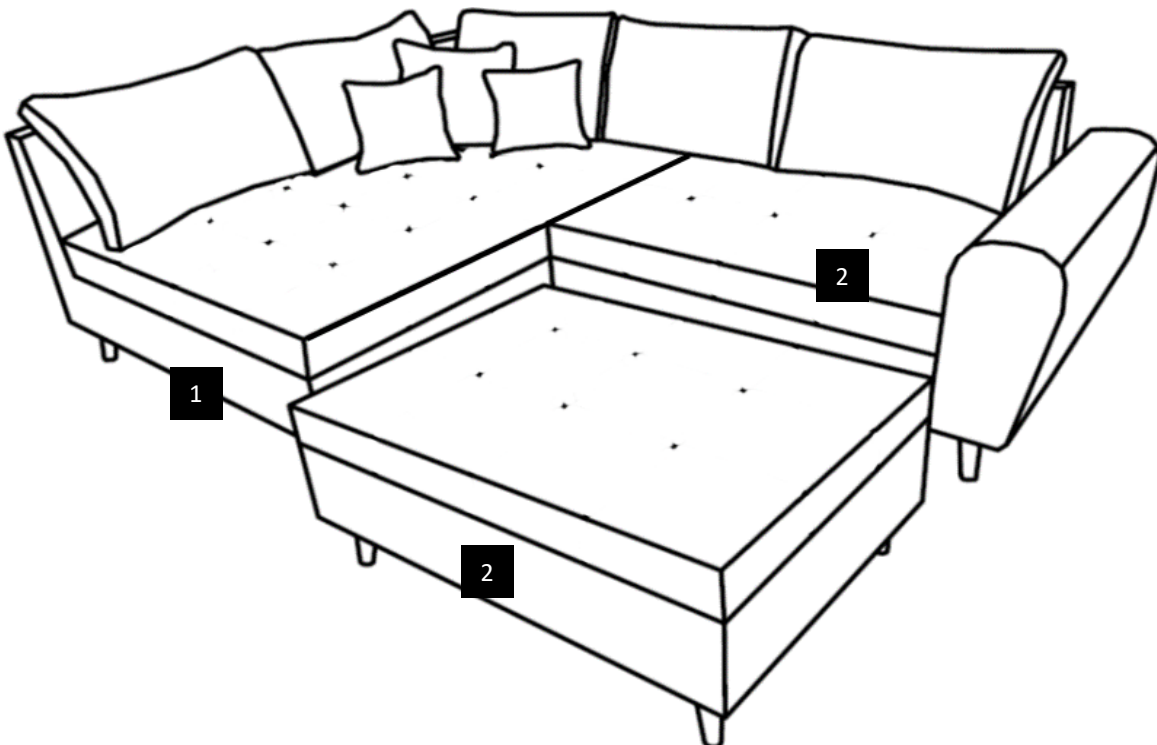
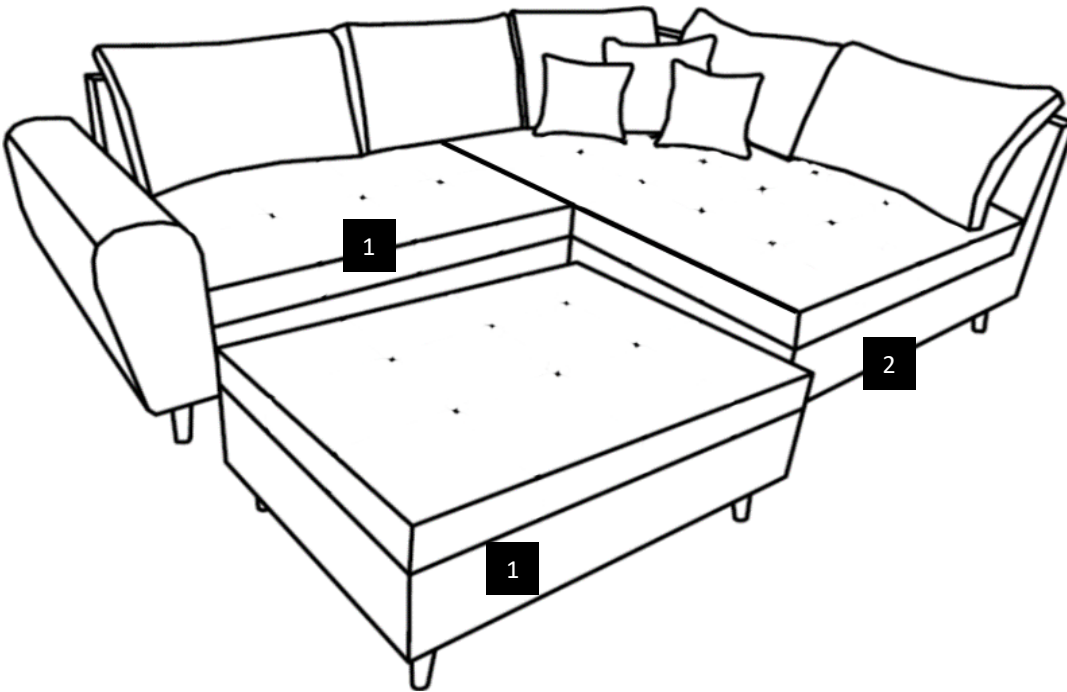



D - Montageanleitung GB - Assembly instructions NL - Handleiding voor de montage
 PL - Instrukcja montazu TR - Montaj talimatı RU - Инструкция по монтажу
 RO - Instrucțiuni de montaj IT - Istruzioni di montaggio FR - Notice de montage
 SK - Navod na monta CZ - Monta ni navod HU - Szerelési utmutató HR - Upute za montažu
 SI - Navodila za montažo BG - Инструкция за сглобяване

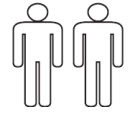

2/4

Name-Naam-Nazwa-Isim-Название-Nume-Nome-Nom-Názov-Název-Nev-Ime-Име

CALANDA REC.2AT+H/2AT.REC+H



B1X5



B2X1



B3X2



A1X12

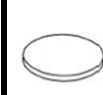

E1X12



1



2

2AT

REC

H

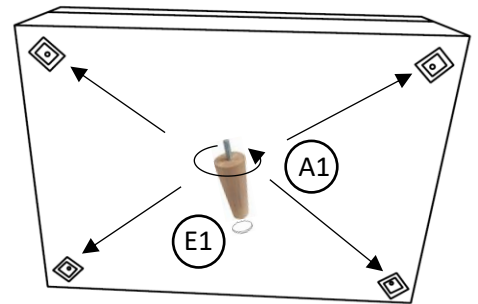
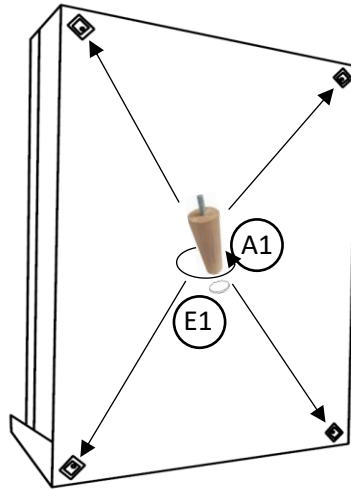
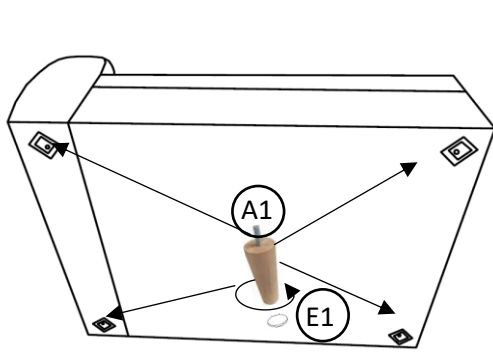

2AT.REC

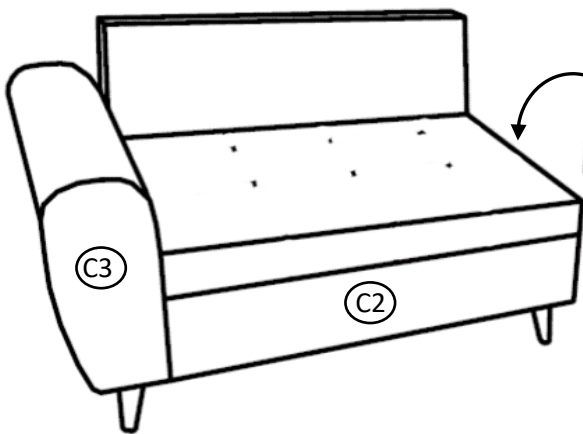

REC.2AT

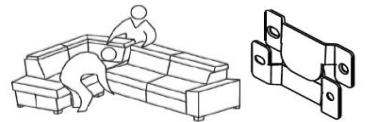
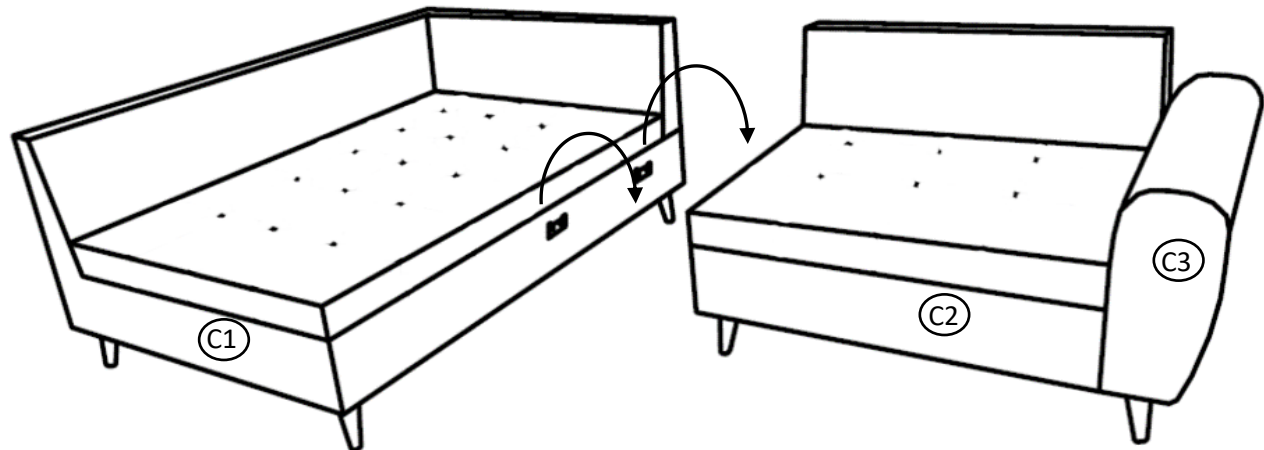



D - Montageanleitung GB - Assembly instructions NL - Handleiding voor de montage
 PL - Instrukcja montazu TR - Montaj talimatı RU - Инструкция по монтажу
 RO - Instrucțiuni de montaj IT - Istruzioni di montaggio FR - Notice de montage
 SK - Navod na montáž CZ - Monta ni navod HU - Szerelési utmutató HR - Upute za montažu
 SI - Navodila za montažo BG - Инструкция за сглобяване

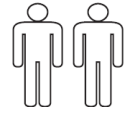

3/4

Name-Naam-Nazwa-Isim-Название-Nume-Nome-Nom-Názov-Název-Nev-Ime-Име

CALANDA REC.2AT+H/2AT.REC+H



B1X5



B2X1



B3X2



A1X12

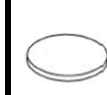

E1X12



1



2

REC.2AT+H

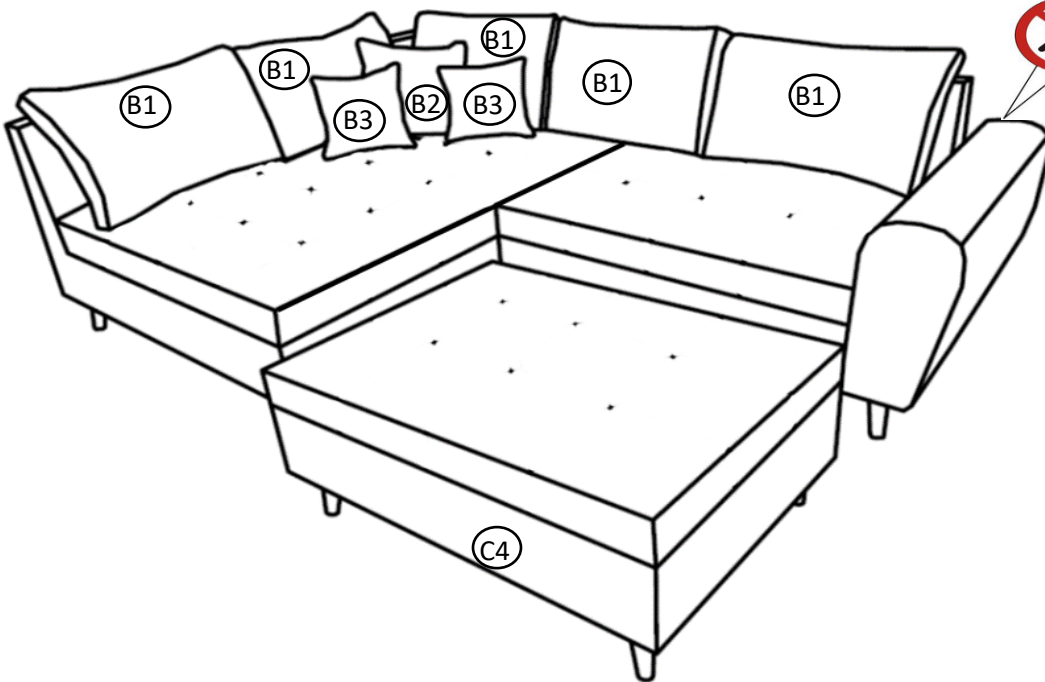

2AT.REC+H





D - Montageanleitung GB - Assembly instructions NL - Handleiding voor de montage
 PL - Instrukcja montazu TR - Montaj talimatı RU - Инструкция по монтажу
 RO - Instrucțiuni de montaj IT - Istruzioni di montaggio FR - Notice de montage
 SK - Navod na monta CZ - Monta ni navod HU - Szerelési utmutató HR - Upute za montažu
 SI - Navodila za montažo BG - Инструкция за сглобяване

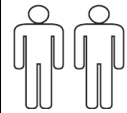

4/4

Name-Naam-Nazwa-Isim-Название-Nume-Nome-Nom-Názov-Název-Nev-Ime-Име

CALANDA REC.2AT+H/2AT.REC+H

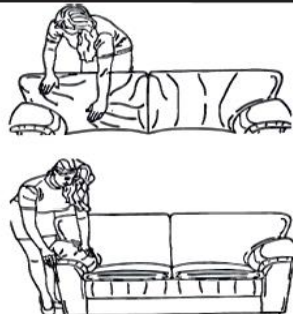
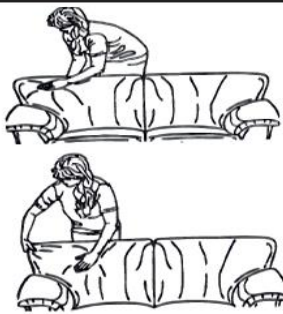
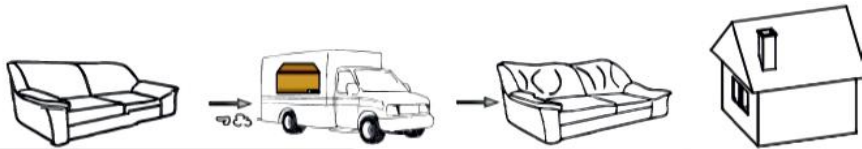
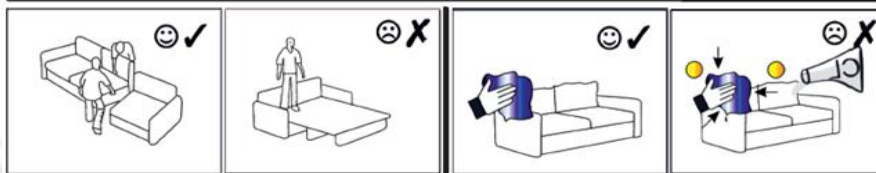
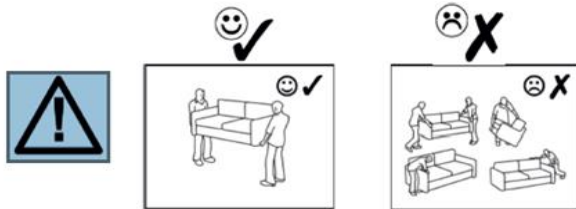
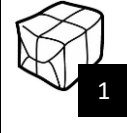
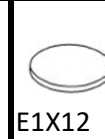

DE

Liebe Kundin, lieber Kunde,

Ihr neues Sofa ist nach dem anstrengenden Transport ein wenig „gestresst“ und das sieht man ihm auch an.

Deshalb:

- Streichen, Klopfen und Schütteln Sie alle Polster ein wenig zurecht, so wie es die Zeichnungen zeigen.
- Das verleiht dem Sofa Aussehen, Eleganz und Attraktivität.

Viel Freude an Ihrem neuen Sofa wünscht Ihnen

Ihre Produktentwicklung

GB

Dear customer,

Your new sofa is somewhat "stressed" from the strenuous transport as can be seen.

For this reason:

- Smooth, knock, and shake all upholstery somewhat to achieve the appearance shown in the illustrations.
- This leaves your sofa looking prim, elegant, and inviting.

We wish you plenty of enjoyment with your new sofa

Your product development team

Service-Dienstverlening-Serwis-Servis-Сервисная служба-Serviciu-Servizio-Služby-Szerviz-Storitev-Обслужване

Typ-Type-Tip-Tip-Tastati-Tipo-Típus

C1		B1			
C2		B2			
C3		B3			
C4		E1			
A1					



Serien-/Chargen-Nr.-