

Manchester

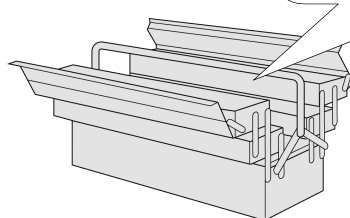

- | | |
|----------------------------------|---------------------------------------|
| D Montageanleitung | GB Assembly instructions |
| FR Notice de montage | NL Handleiding voor de montage |
| CZ Montážní návod | IT Istruzioni di montaggio |
| RO Instrucțiuni de montaj | RU инструкция по сборке |
| PL Instrukcja montażu | SK Návod na montáž |
| HU Szerelési útmutató | TR Montaj talimatı |

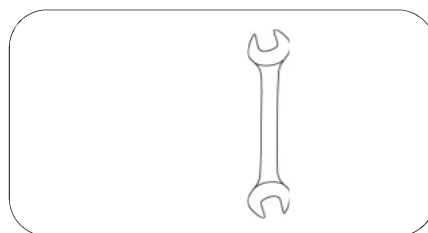
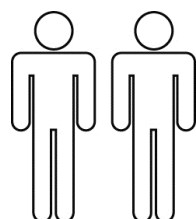

0
10
20
30
40
50
60
70
80
90
100
110
120
130
140
150
160
170
180
190
200

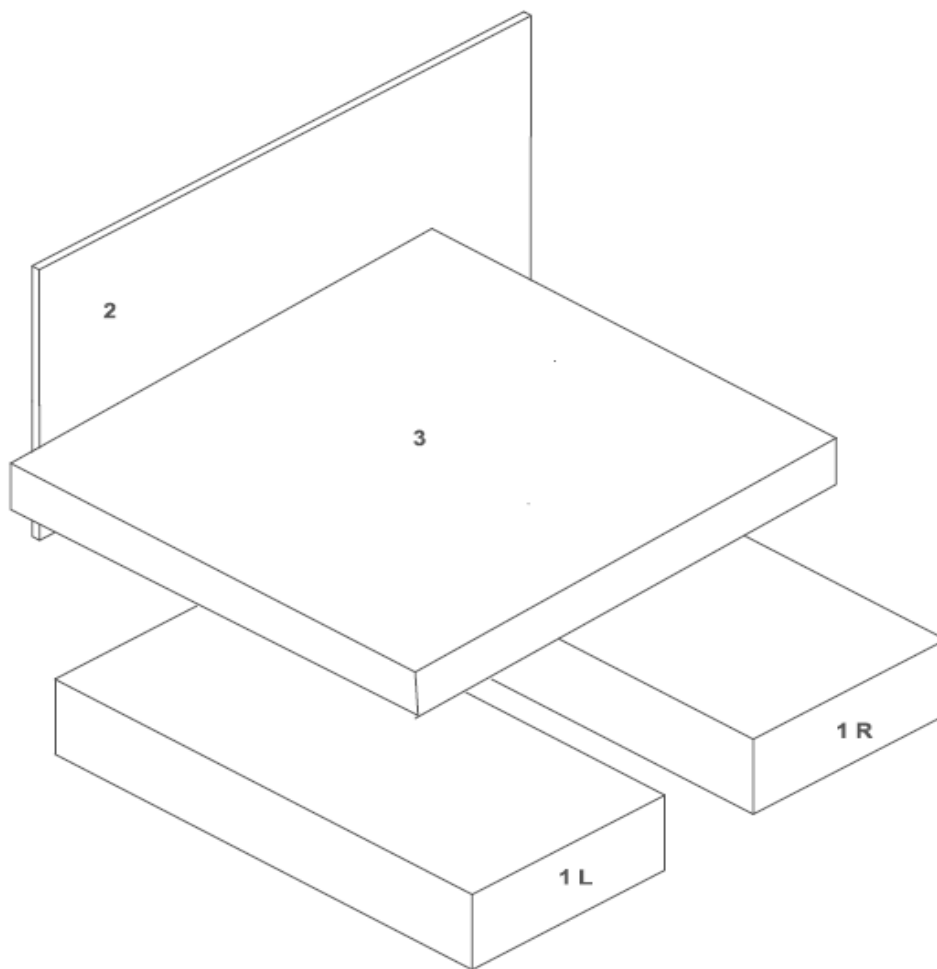

Service • Assistenza • Dienstverlening • Serwis Servis • Szerviz • Сервисная служба		
Name • Nom • Nome • Naam Nazwa • Jméno • Názov • Név Denimire • İsim • Название	Manchester 140	
Nr. • No. • N° • Номер • Č • Sz	SH54	
Typ • Type • Tip • Típus • Tipo Тип	BS I	

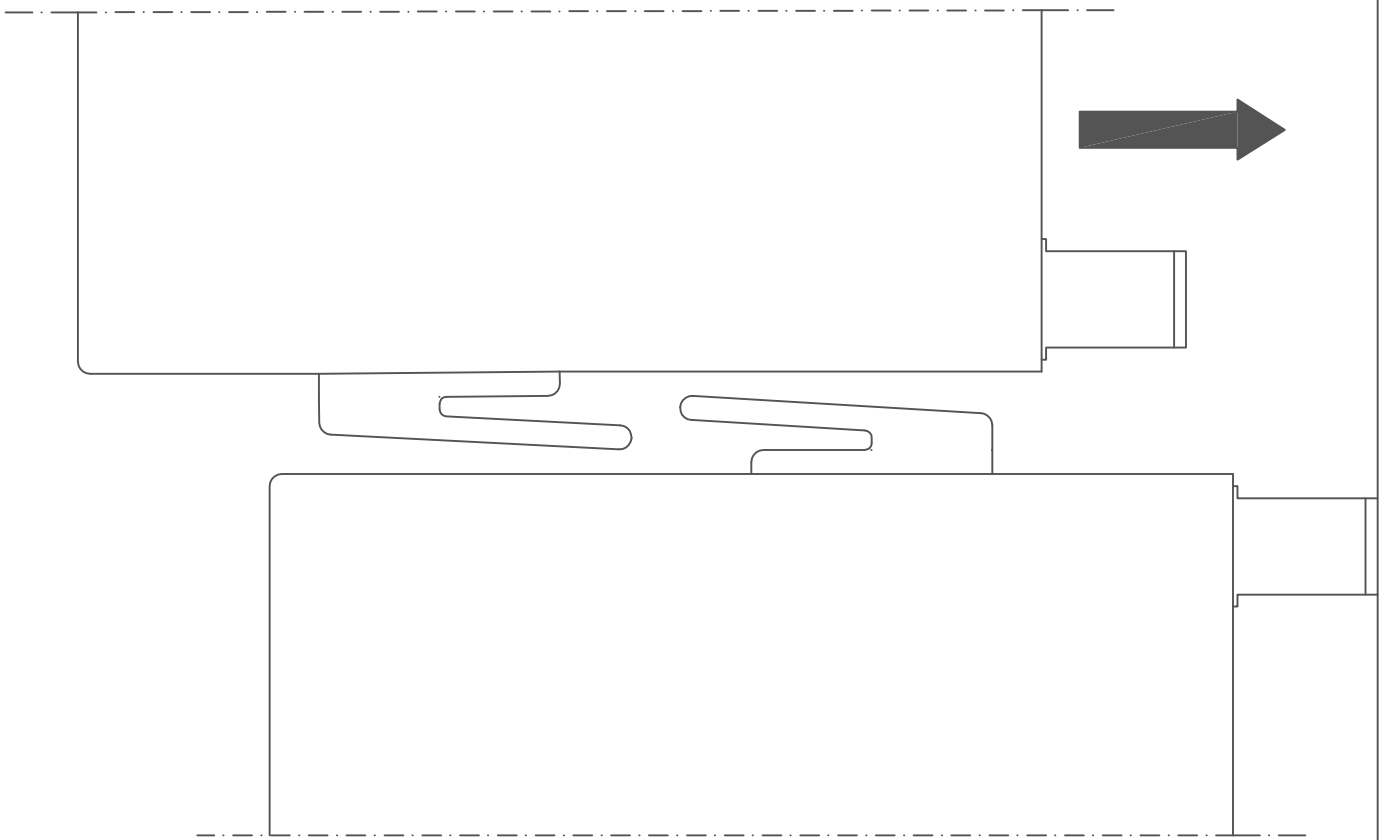

A	B	C
8x 8x60	8x 8x40	8x M8



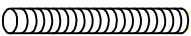

<p>A</p>  <p>8x 8x60</p>	<p>B</p>  <p>8x 8x40</p>	<p>C</p>  <p>8x M8</p>	<p>Achtung! Schrauben nicht überdrehen FR Attention! Ne serrez pas trop CZ Dávej Pozor! Nepřetahujte RO Ai Grija! Nu strângeți PL Uwaga! Nie dokręcać zbyt mocno HU Vigyázz! Ne húzza túl</p> <p>GB Watch Out! Do not over tighten NL Let Op! Niet te vast IT Attento! Non stringere RU Осторожно! Не затягивайте SK Dávaj Pozor! Nepretahujte TR Dikkat! Üzerinde sıkmayın</p>
---	---	---	---

