

Lörby (1AL130-1AL130)



- | | |
|----------------------------------|--------------------------------|
| (DE) Montageanleitung | (FR) Notice de montage |
| (PL) Instrukcja montażu | (RO) Instrucțiuni de asamblare |
| (NL) Handleiding voor de montage | (SK) Montážny návod |
| (GB) Assembly instructions | (CZ) Montážní návod |
| (TR) Montaj talimatı | (HU) Szerelési útmutató |
| (RU) Инструкция по монтажу | (SLO) Navodila za montažo |
| (IT) Istruzioni di montaggio | |

Service - Servis - Dienstverlening - Servis - Serwis - Сервисная служба - Servizio - Service
 Serviciu - Služby - Szolgáltatás - Storitev

Name - Nazwa - Naam - Name - Isim - название
 Nome - Nom - Numele - Meno - Jméno - Neve - Ime

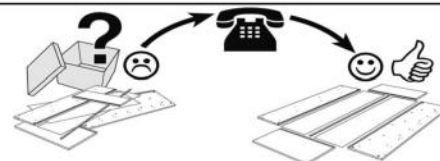



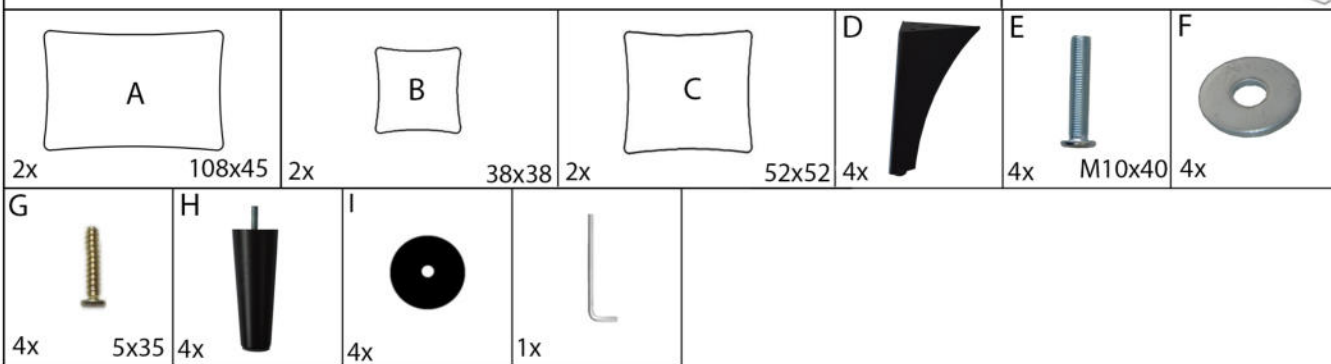

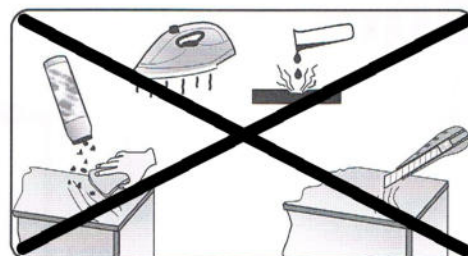
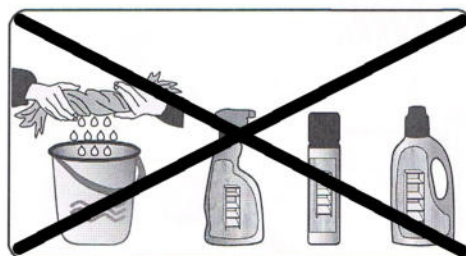
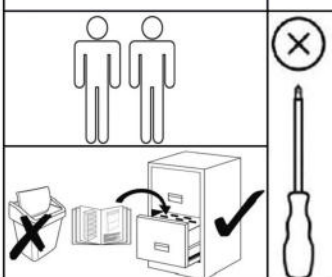

Lörby (1AL130-1AL130)



24-01-2022



- D**  4x
- E**  M10x40 4x
- F**  4x
- G**  5x35 4x
- H**  4x
- I**  4x
- L**  1x

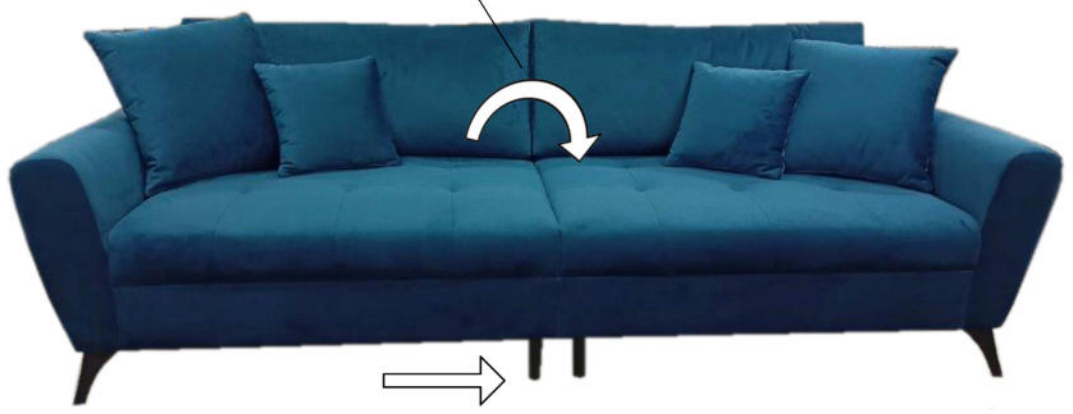
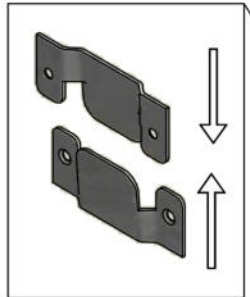
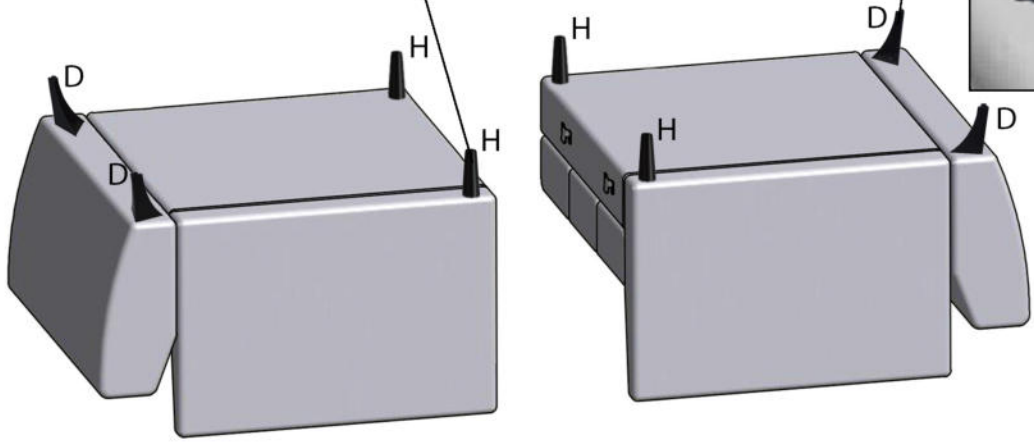
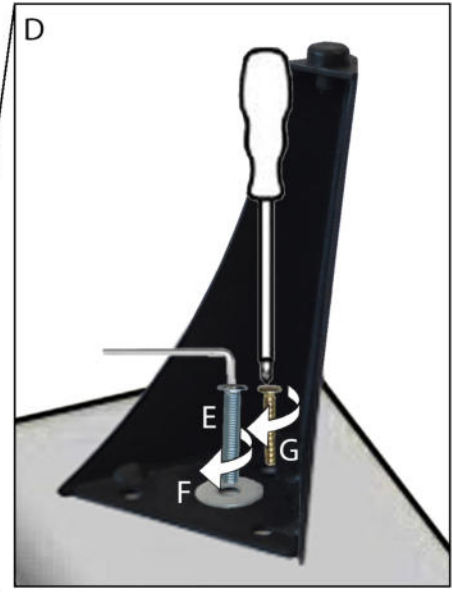
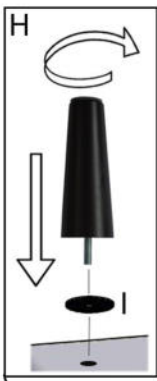

24-01-2022