











DAS 30 Variante

Montageanleitung / Notice de montage / Assembly instruction

			
Ø5mm	34x	16x	3, 5x15





12x

12x

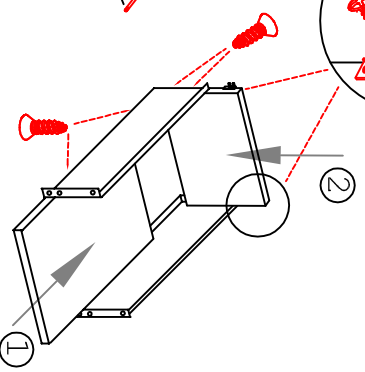
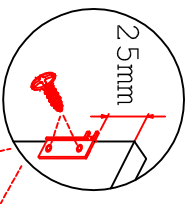
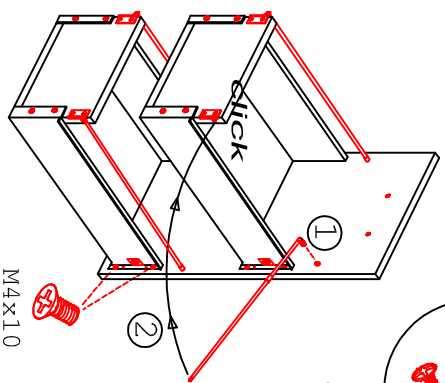
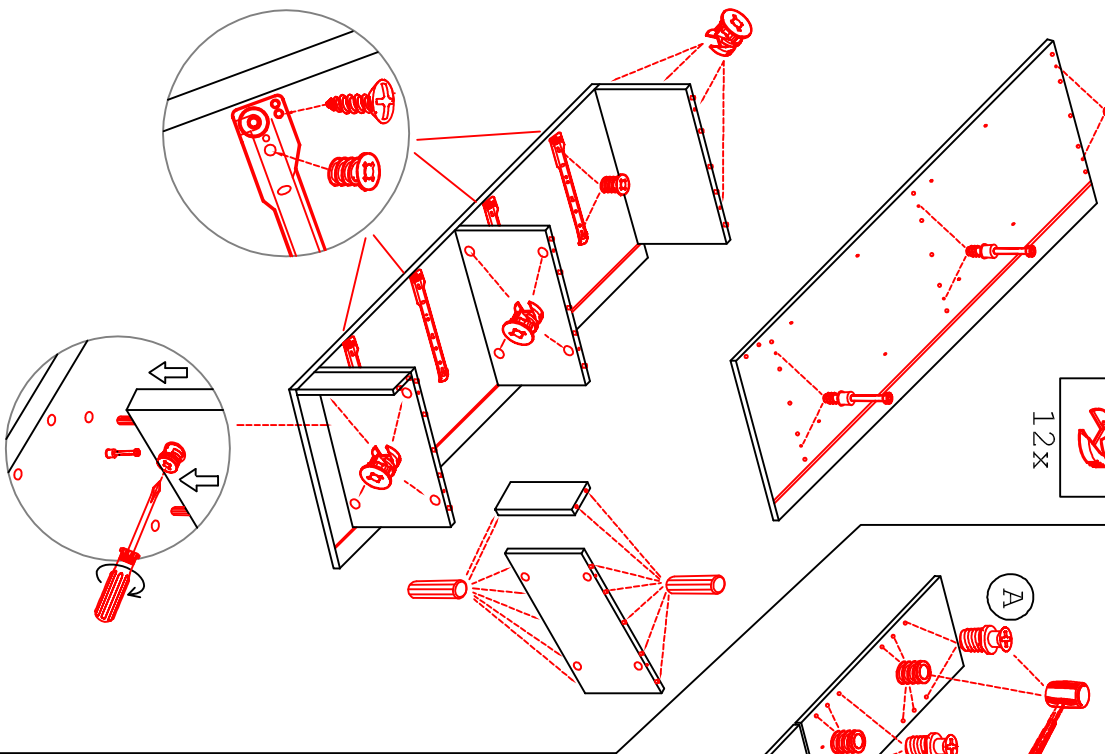
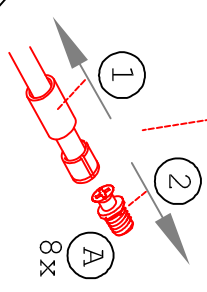
					
Ø8x10	3, 5x15	M4x10	M4x10	8x	4x

16x 48x 15x 16x 8x



				
3, 5x30	4, 5x15	4, 5x15	Ø8mm	

4x 2x 1x 1x 1x

4, 5x50
1x

Klipsicherung !!!
Schränk und Wand mittels Winkel verbinden (unter dem oberen Boden)

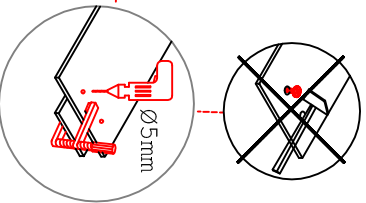
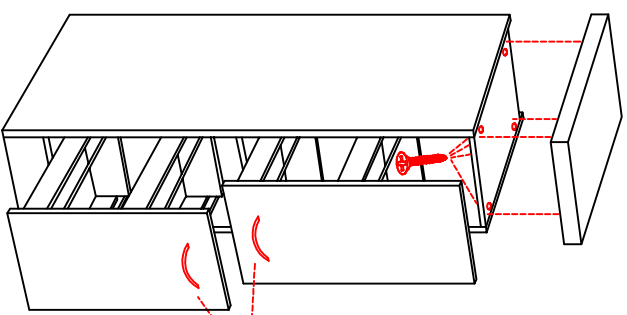
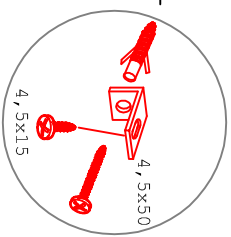

Die Einstellung der Auszug-Blenden bitte durch drehen an den einzelnen Rehringstangen vornehmen. (heranholen oder wegdrücken)

DGIT 60 Variante

Montageanleitung / Notice de montage / Assembly instruction

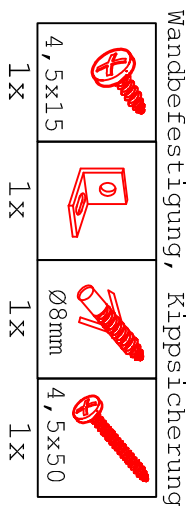
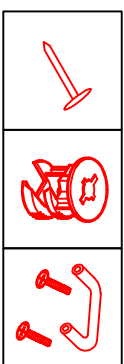
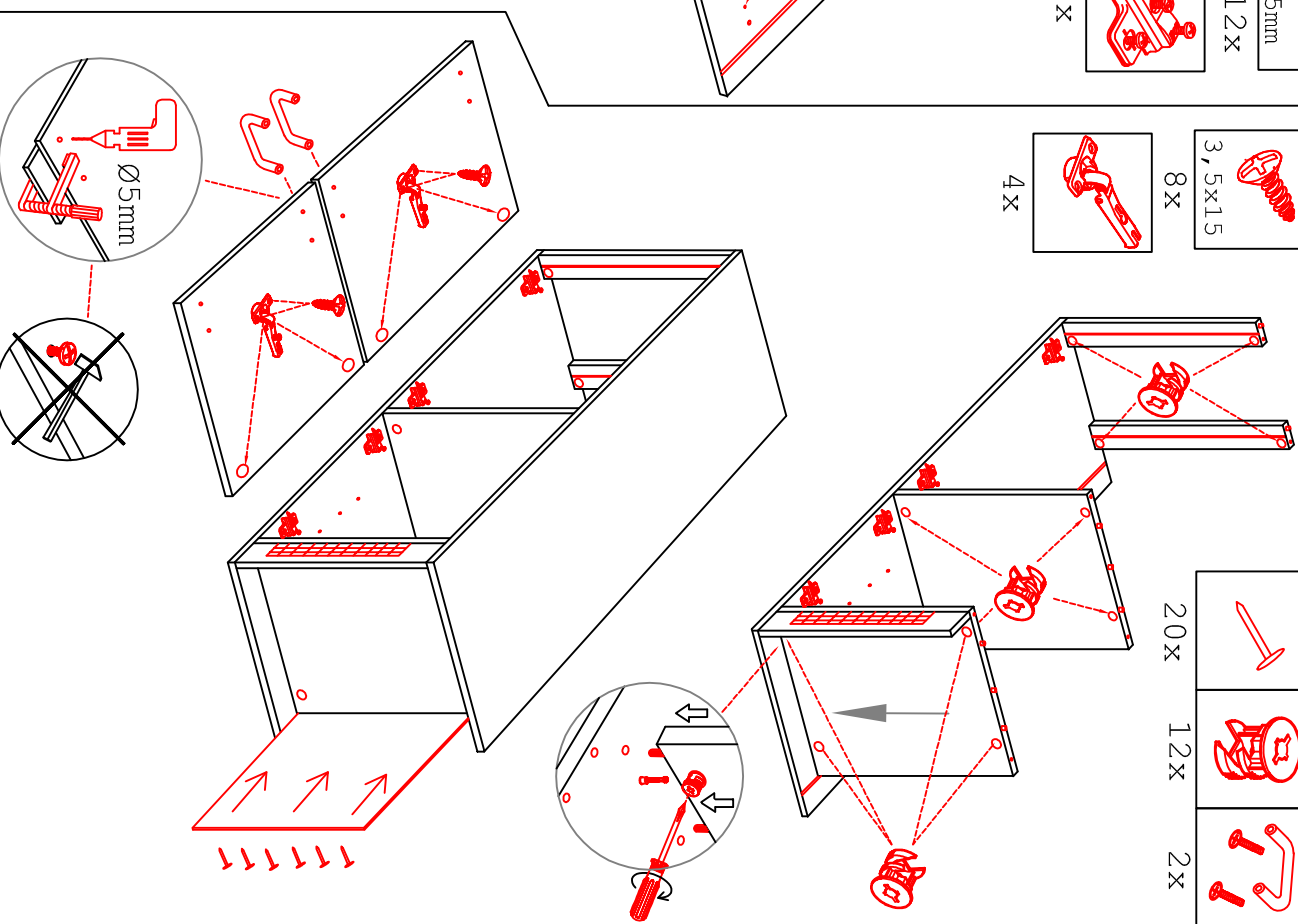
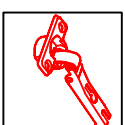
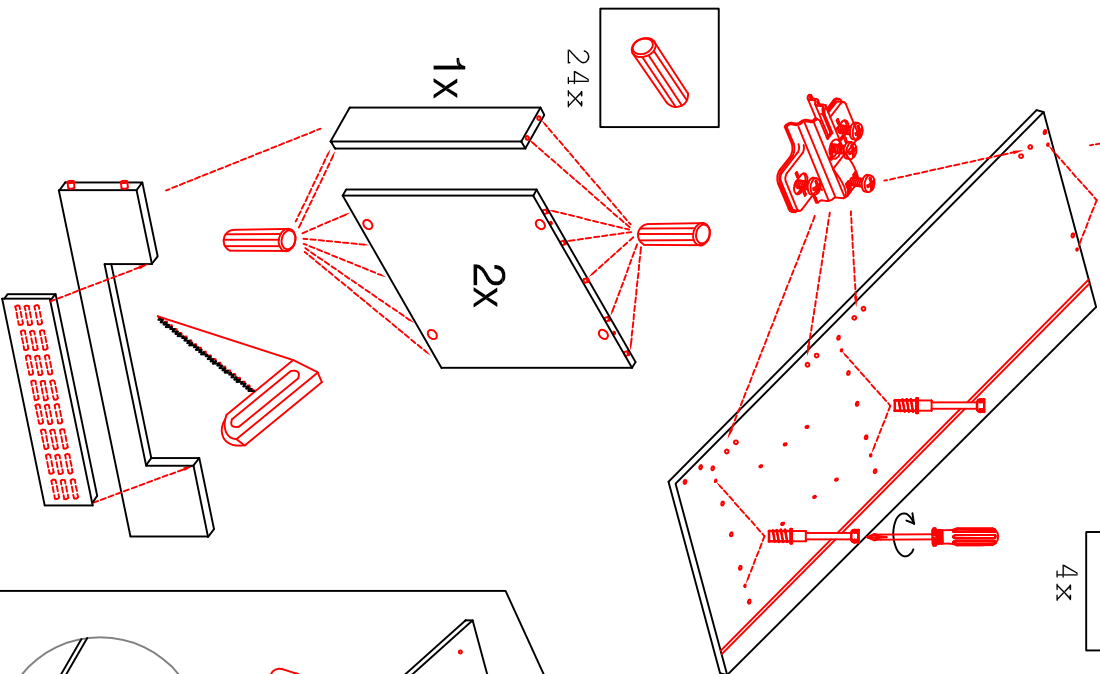
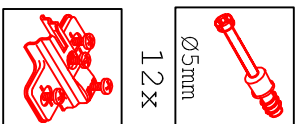
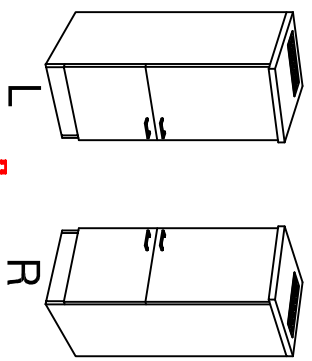

Wandbefestigung, Kippsicherung

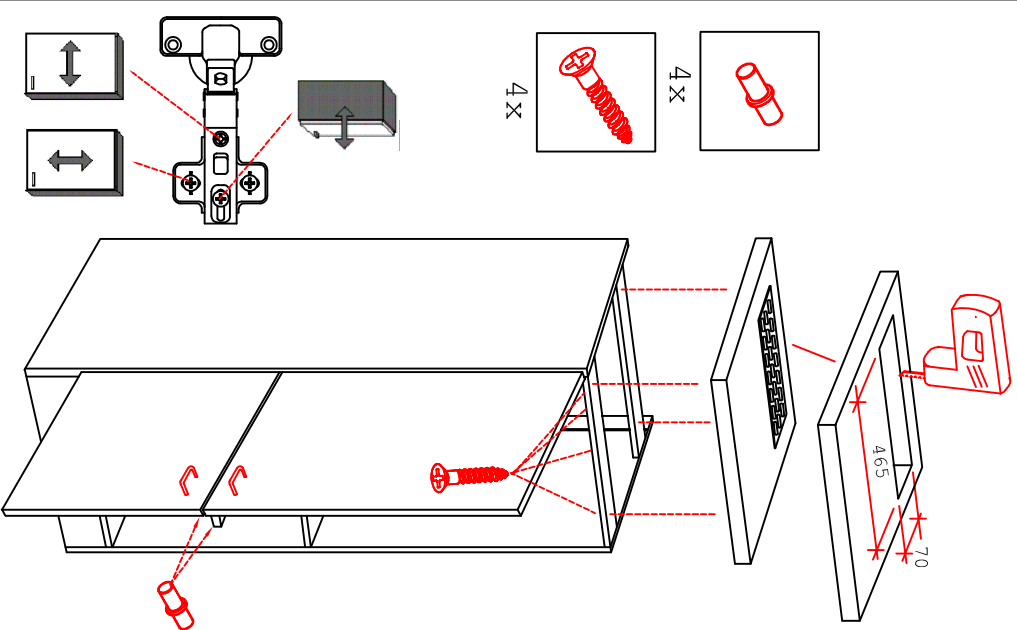
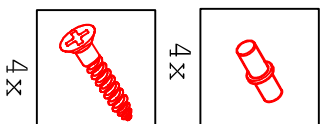

H 80 / H 100 / HG 100 / HGH 100

Variante

Montageanleitung / Notice de montage / Assembly instruction

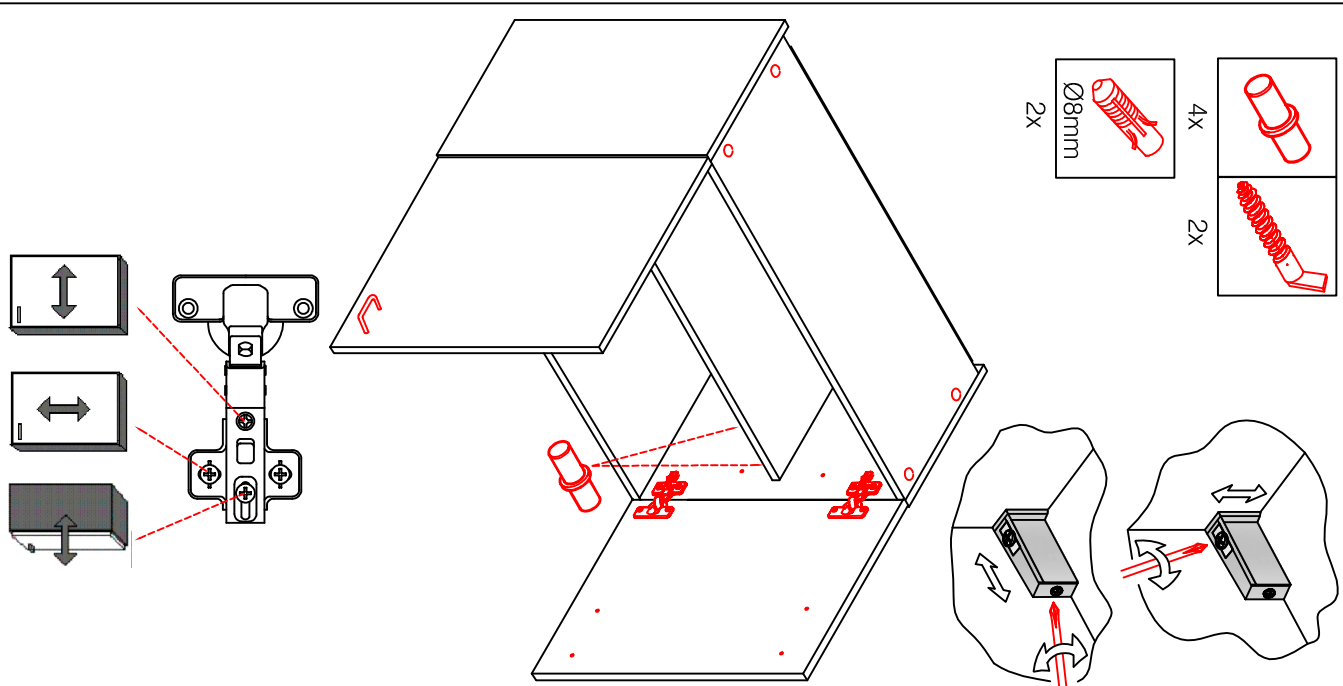
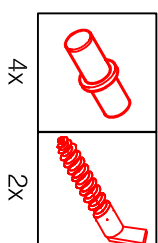
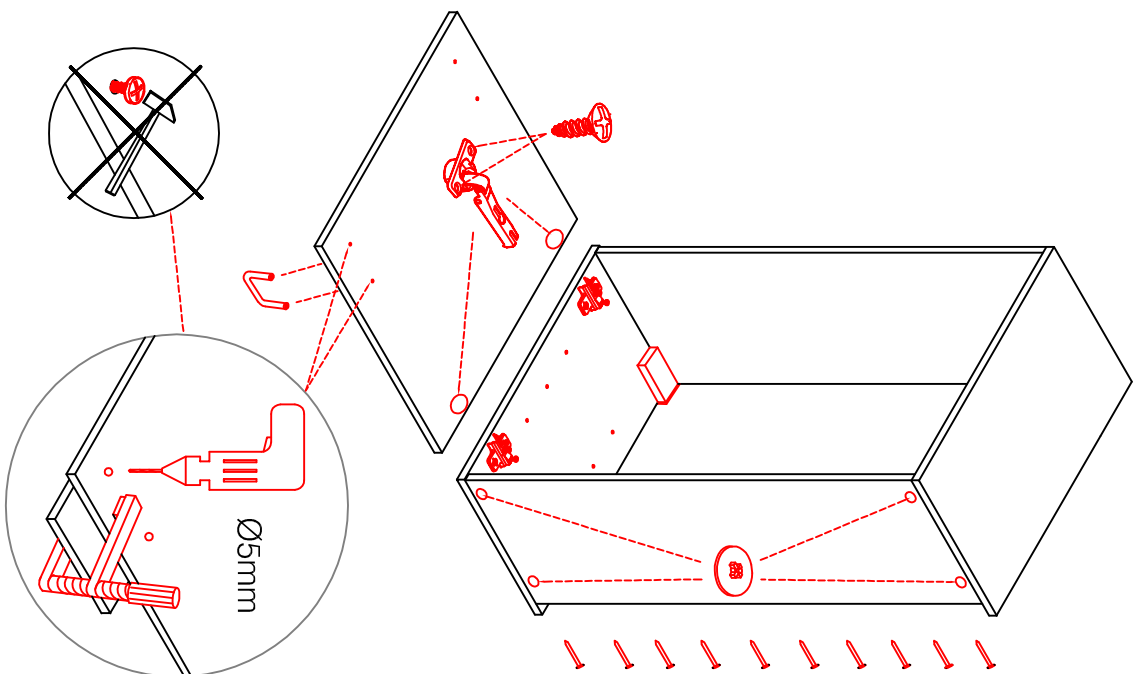
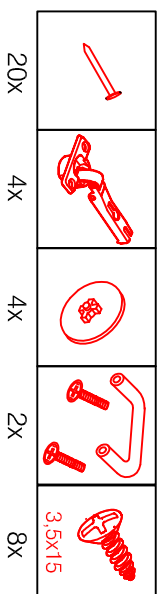
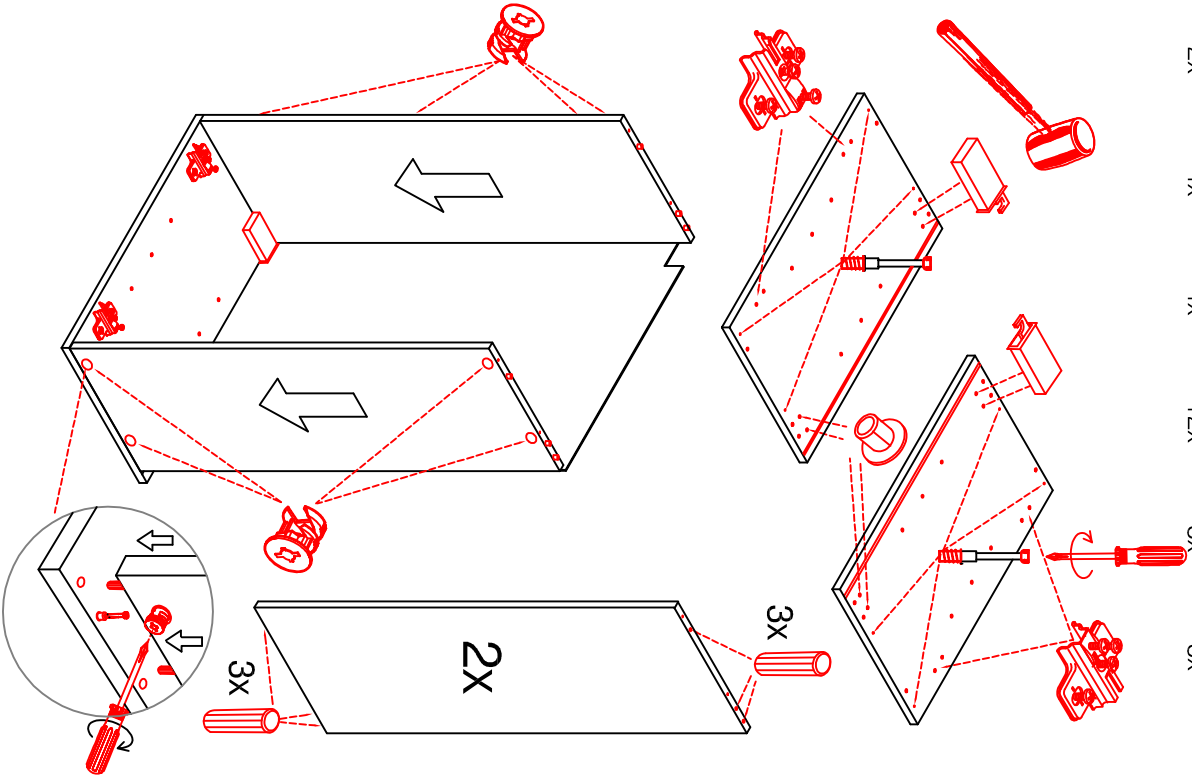
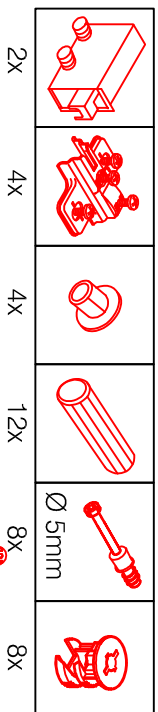

SPU 50 Variante Blocktype

Montageanleitung / Notice de montage / Assembly instruction

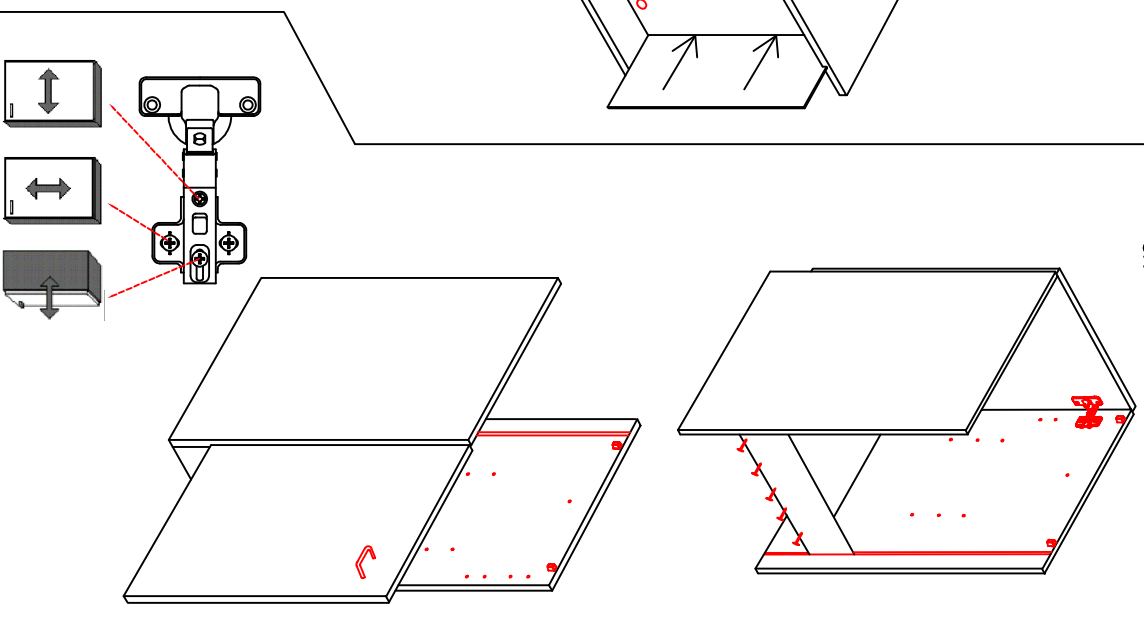
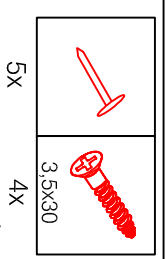
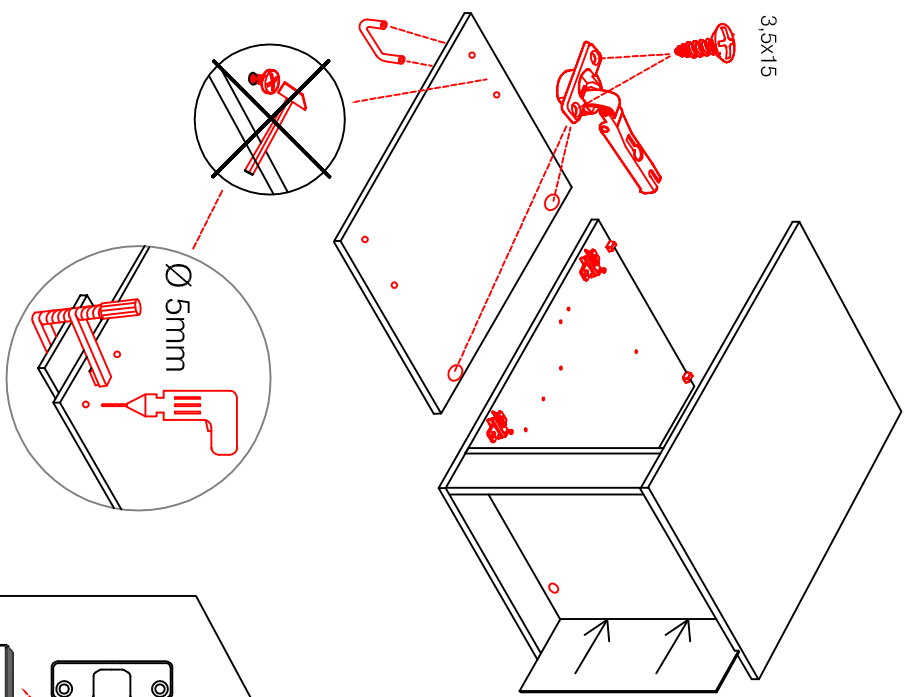
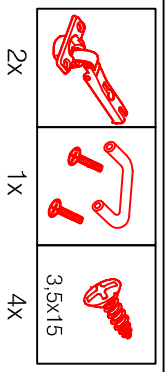
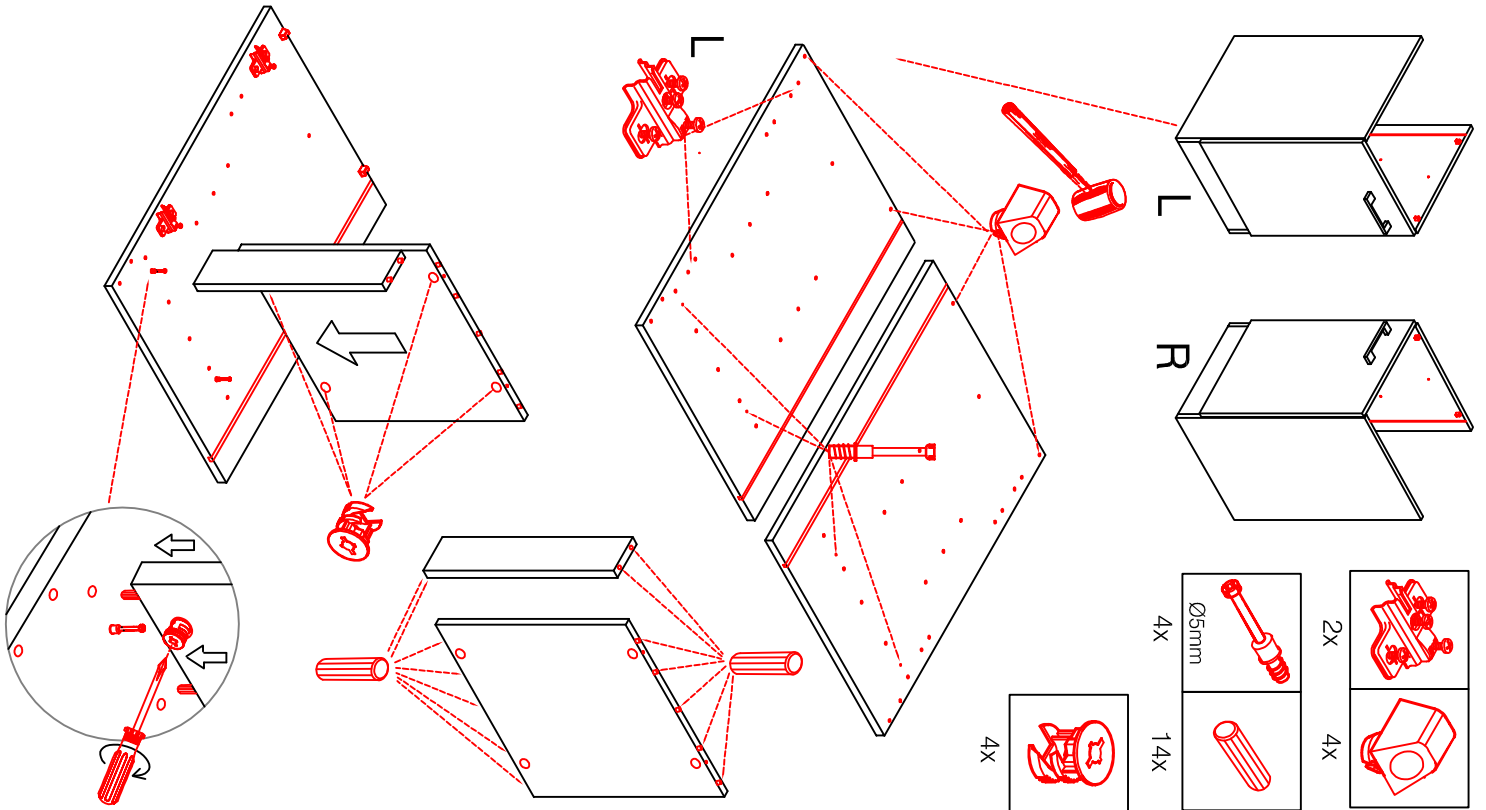
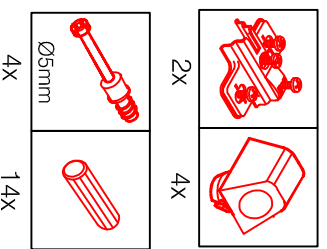

USSA 50 B Variante

Montageanleitung / Notice de montage / Assembly instruction

4x Ø5mm
 16x
 2x 3,5x15
 4x
 6x
 2x
 4x 3,5x15
 4x
 4x
 14x
 4x

6x
 4x Ø8x10
 1x
 2x A
 3,5x15
 4x M4x10
 2x
 12x 3,5x15
 4x M4x10
 2x
 3,5x15
 2,5mm
 3,5x15

6x
 2x
 4x
 1x
 Ø5mm

Die Einstellung der Auszug-Blende bitte durch drehen an den einzelnen Reihingstangen vornehmen. (heranhohlen oder wegdücken)