

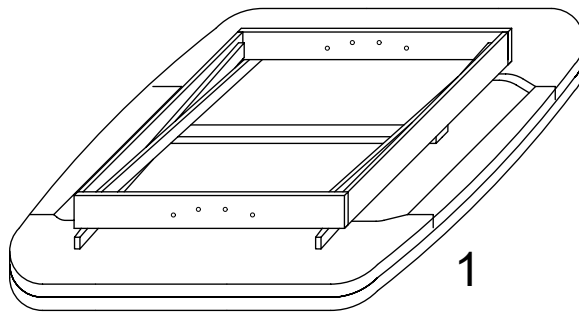

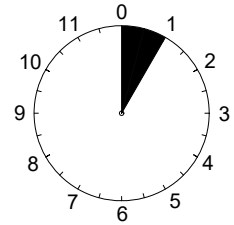

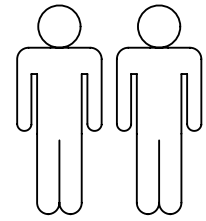

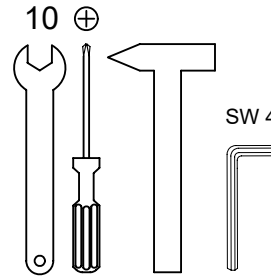

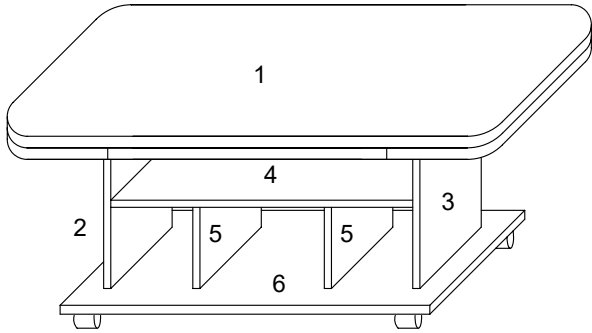

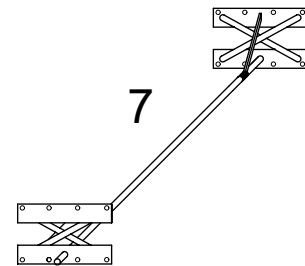
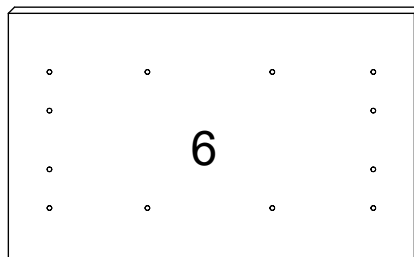
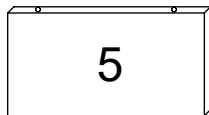
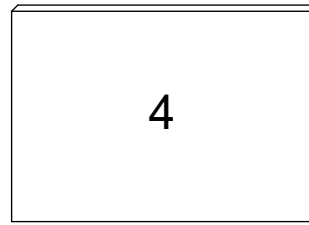
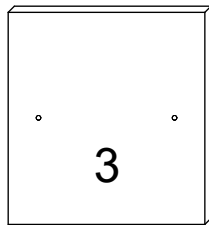
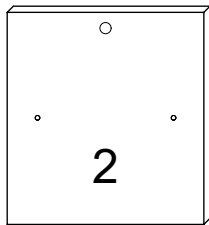
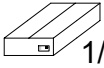
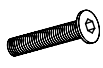

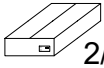
# 270/688 "Babsi III"



		
1	1 x	1/2
2	1 x	2/2
3	1 x	2/2
4	1 x	2/2
5	2 x	2/2
6	1 x	2/2
7	1 x	2/2



 1/2	B  6x35 8x	E  8x			
 2/2	A  7x40 8x	C  4x15 24x	D  8x30 16x	F  4x	G  2x
	H  2x	K  1x	L  1x		

I.

1.

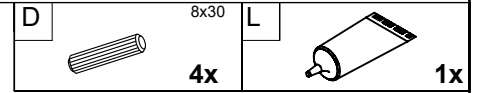
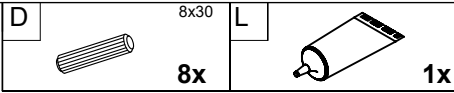
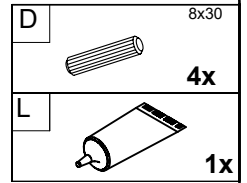
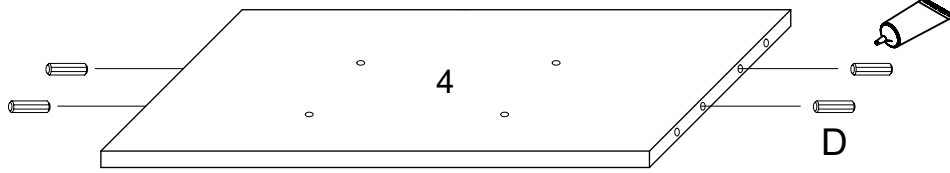

2.

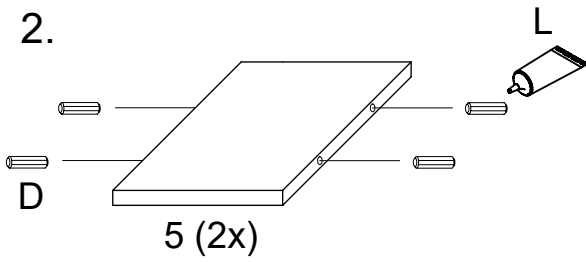

5 (2x)

3.

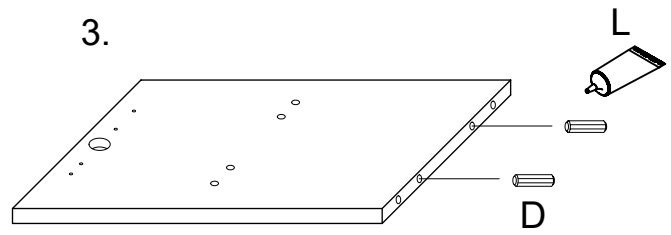

2+3

4.

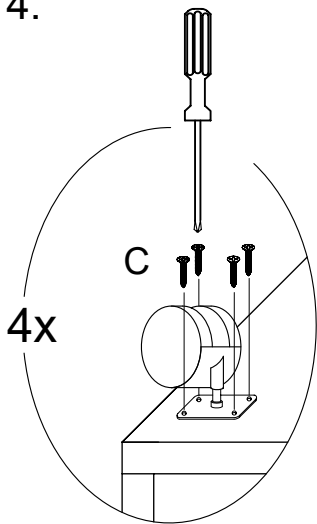

4x

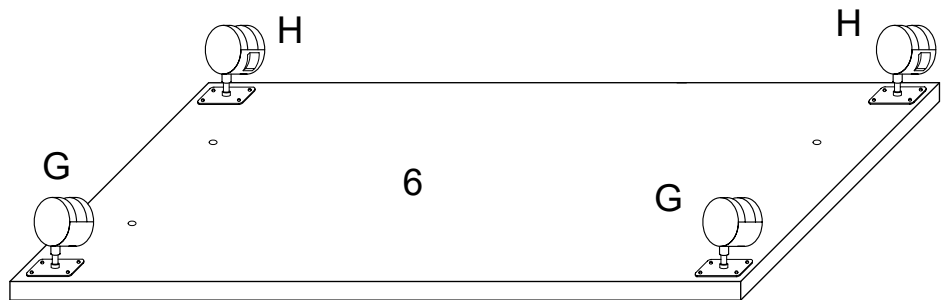
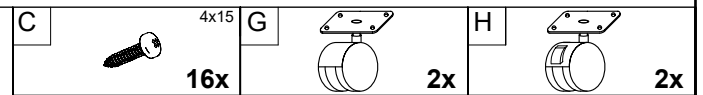



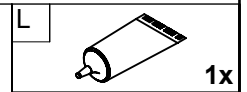
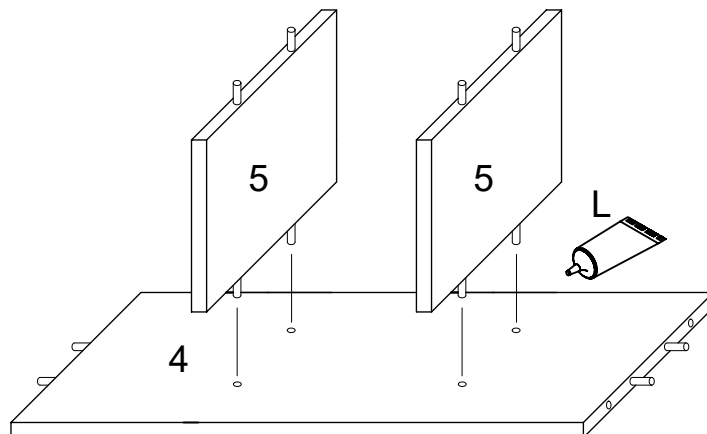



5.

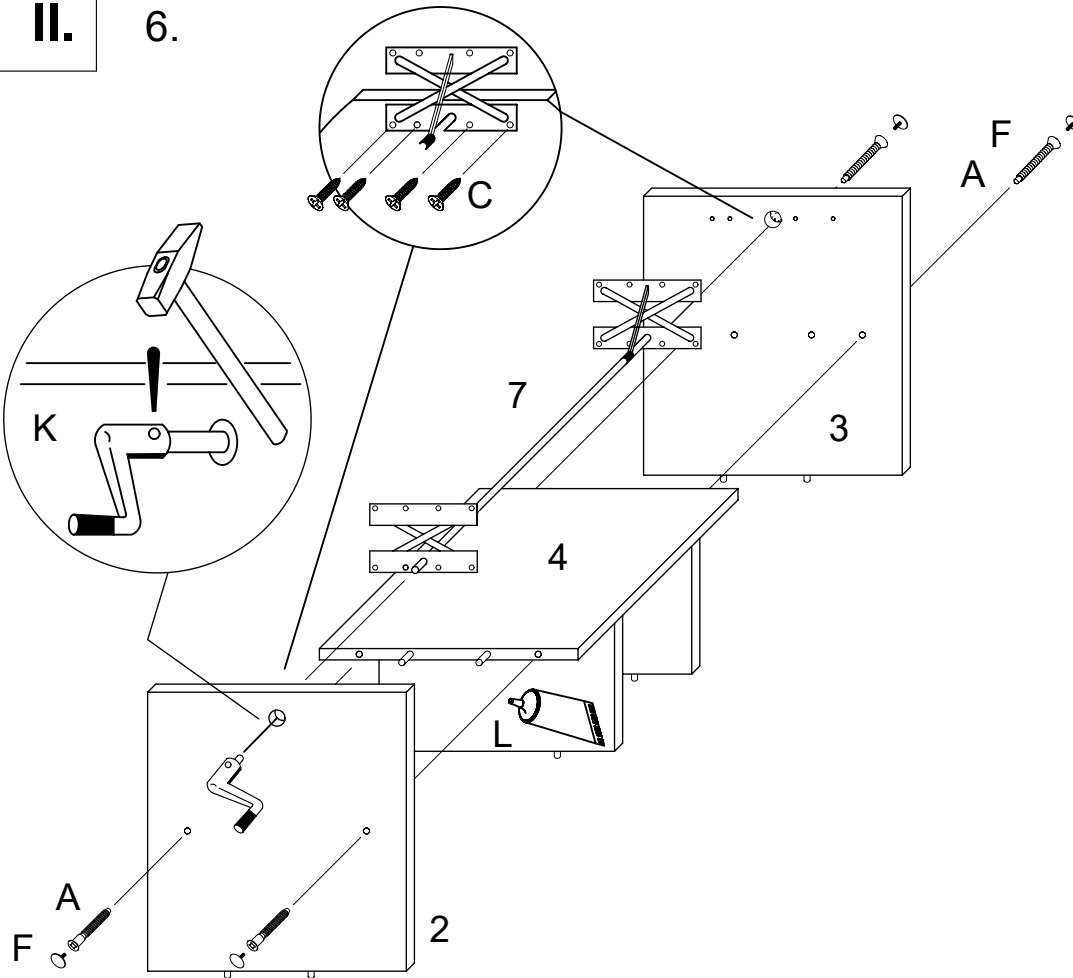

II.



6.

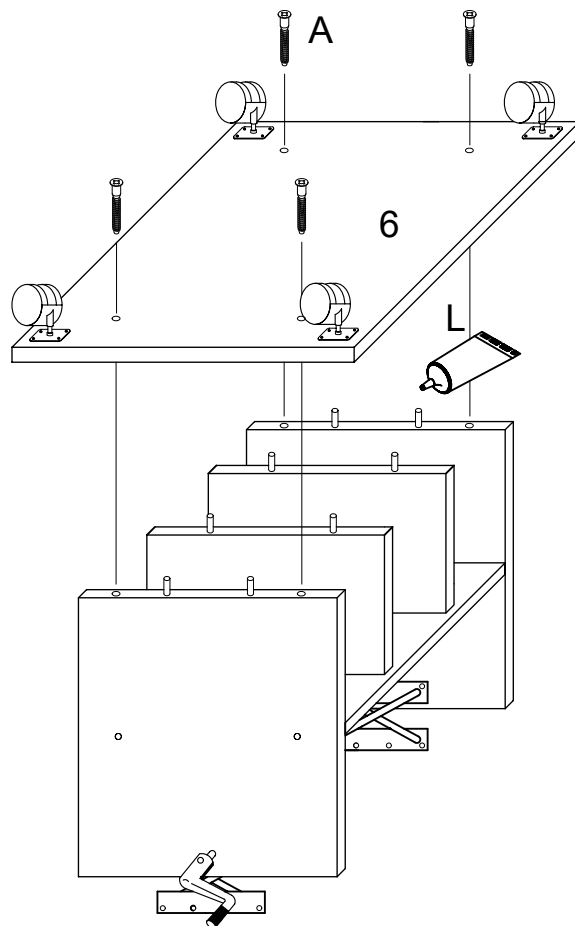

A		7x40	4x
C		4x15	8x
F			4x
K			1x
L			1x

7.

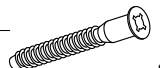

A		7x40	4x
L			1x

III.

8.

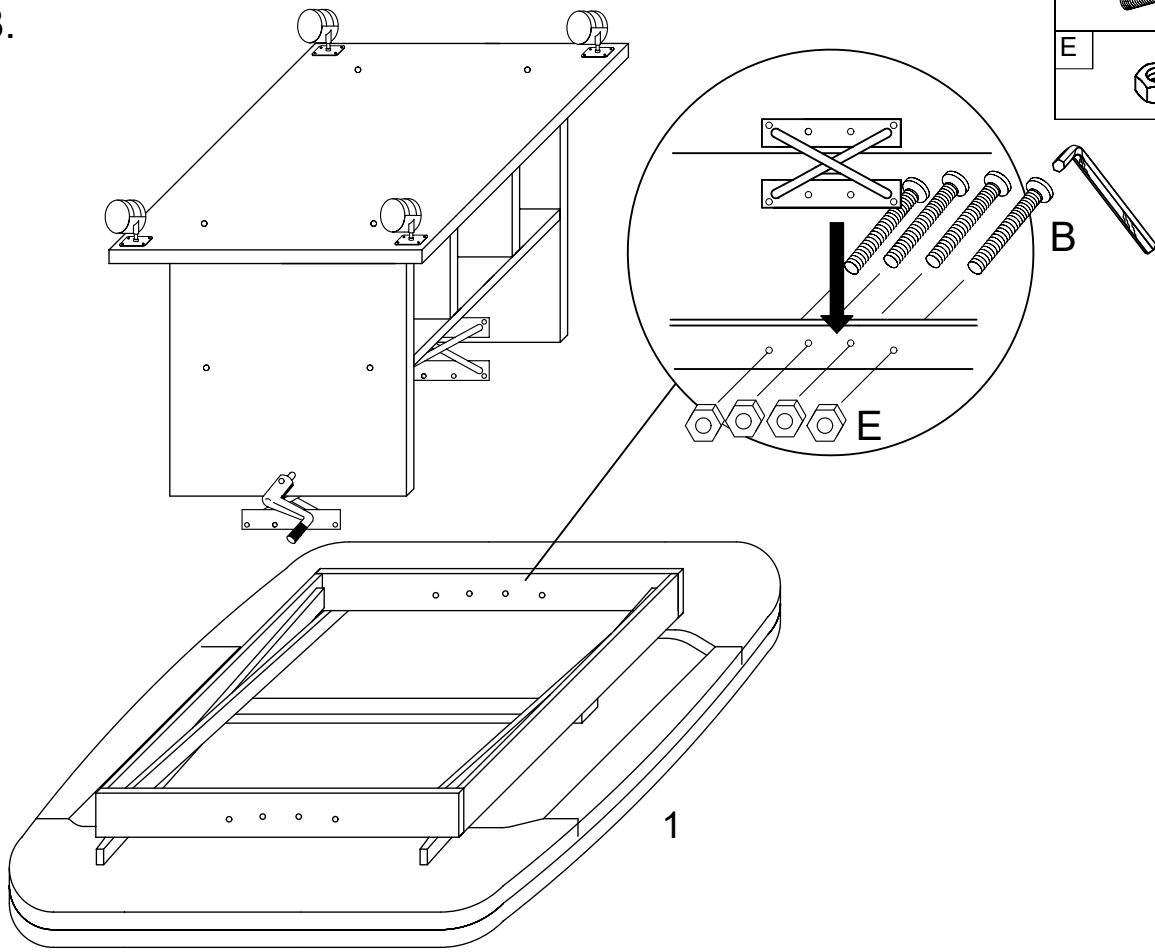

9.

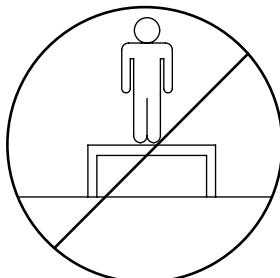
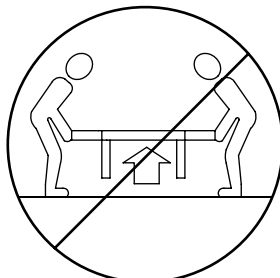
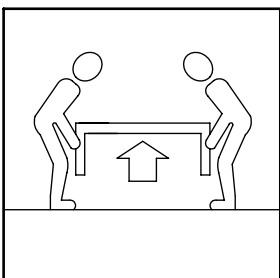
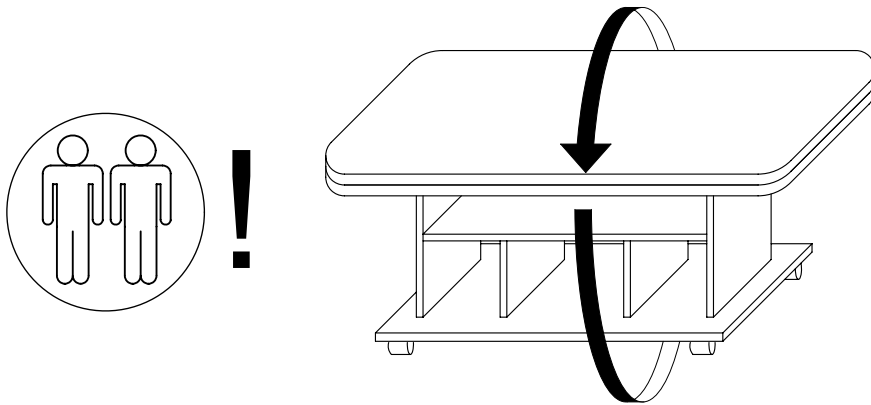

LE TRI  
+ FACILE



BAC  
DE  
TRI

Séparez les éléments avant de trier