

32____-P2

Montageanweisung / Installation instructions / Instruction de montage / Istruzioni di montaggio
montagehandleiding / Instrukcja montażu / Montaj talimatlar / Osszeszerelési útmutató / Návod k montáži /
Návod na montáž / Instrucțiune de montaj / Инструкция по монтажу / Montaj talimatina / Monteringsanvisningar
Upute za montažu / Instrucciones de Montaje / Navodila za montažo

BASIC
SALERNO 10501808

LIDIA 10501611

LAND

SKY

URBINO

CARRARA

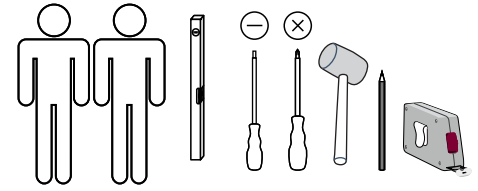
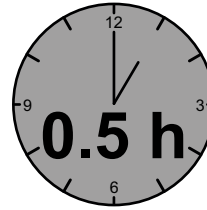

LC S.p.A
Via del Piano s.n
61030 Isola del Piano (PU)
Italia
<http://www.lcmobili.com/>

D – bitte lesen sie diese montageanleitung gut durch,
Da wir für fehler, die durch falsche montage entstehen,
Keine haftung übernehmen!

Gb – please read these installation instructions
Through carefully as we cannot accept any liability
For faults occurring as a result of incorrect installation!

Cz – přečtete si prosim pozorně tento návod k montáži,
Aby jste předešli chybám vzniklých špatnou montáží,
Za které neručíme!

F – veuillez lire attentivement cette notice de montage,
Car nous déclinons toute responsabilité en cas d'erreurs
Découlant d'un montage erroné !

I – prego leggere attentamente le istruzioni per il montaggio,
Poiché decliniamo qualsiasi responsabilità
Per difetti derivanti da montaggio errato.

S - läs monteringsanvisningarna noggrant.
Vi avsäger oss allt ansvar för defekter som
Uppstår p.g.a. Felaktig montering.

Hr – pažljivo pročitajte upute za montažu,
Jer otklanjamo svaku odgovornost za pogreške
Nastale uslijed pogrešne montaže.

Slo – prosimo, da pozorno preberete navodila za montažo,
Saj zavračamo vsakršno odgovornost za napake,
Ki bi nastale zaradi napačne montaže.

NI – leest u alstublieft deze montagehandleiding goed door,
Voor fouten door verkeerde montage zijn wij niet verantwoordelijk.

PI – prosze uwaznie zapoznac sie z instrukcja montazu,
Poniewaz nie ponosimy odpowiedzialnosci za niewlasciwy montaz.

HU – Kérjük, olvassa el figyelmesen
ezt az összeszerelési útmutatót,
mert a helytelen összeszerelésből
a dódó hibákért nem vállalunk felelősséget!

SK – Prosime, dobre prečítajte si tento návod na montáž,
pretože nepreberáme žiadne ručenie za chyby,
ktoré vzniknú na základe chybnej montáže!





RO – Vă rugăm să cititi cu atenție aceste instrucțiuni
de montaj deoarece nu preluăm garanția pentru defecte
ce apar datorită unui montaj incorect!

RUS – Пожалуйста, внимательно ознакомьтесь ù
с данной инструкцией по монтажу, поскольку мы не
несем ответственности за ошибки, причиной которых
является неправильный монтаж.

TU – İlkonce kullanma klavuzunu iyi okkuyun,
yalnis montaj yapasaniz bunun sorumlusu biz degiliz.

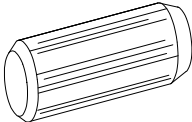
ES – Se ruega leer con atención las instrucciones
de montaje debido a que declinamos cualquier
responsabilidad
por defectos derivados de un montaje erróneo.

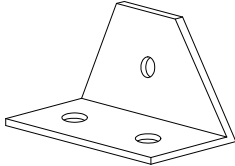
ONDERDELEN LYST-SERVICEKARTE-FORMULAIRE DEMANDES SAV-SPAREPARTS LIST-SCHEDA DI SERVIZIO
BESLAG-BESCHLAEGE - QUINCALLERIE - HARDWARE - FERRAMENTA

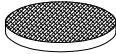
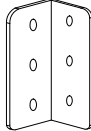
B	 8x30 mm.	x8	L3	 4x18 mm.	x24
P7		x8	L4	 4,5x40 mm.	x24
F3		x8	P13		x4

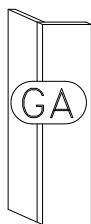
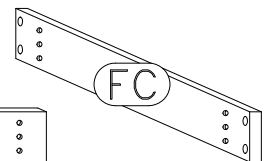
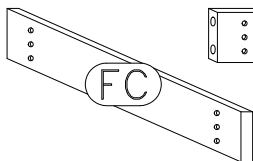

1

B

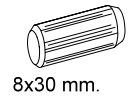

x8

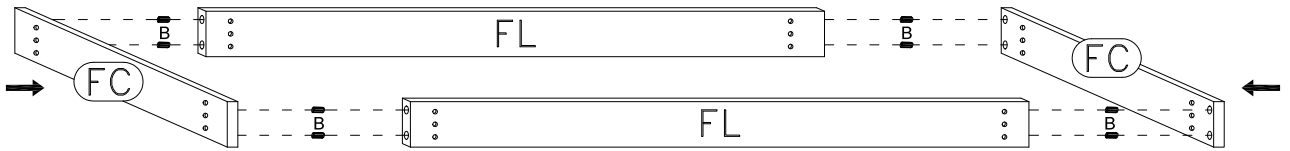
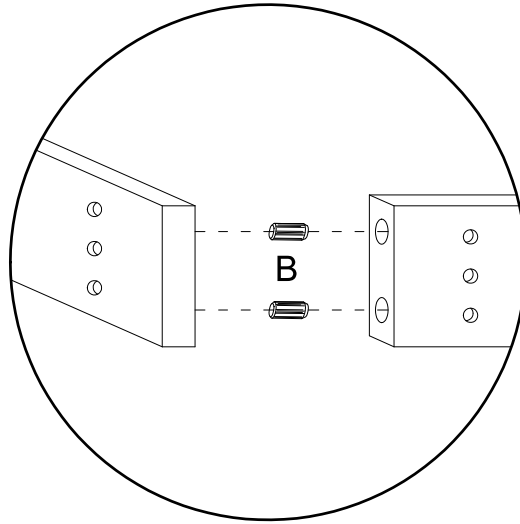

2

F3



x8

L4



4.5x40 mm. x24

P13



x4

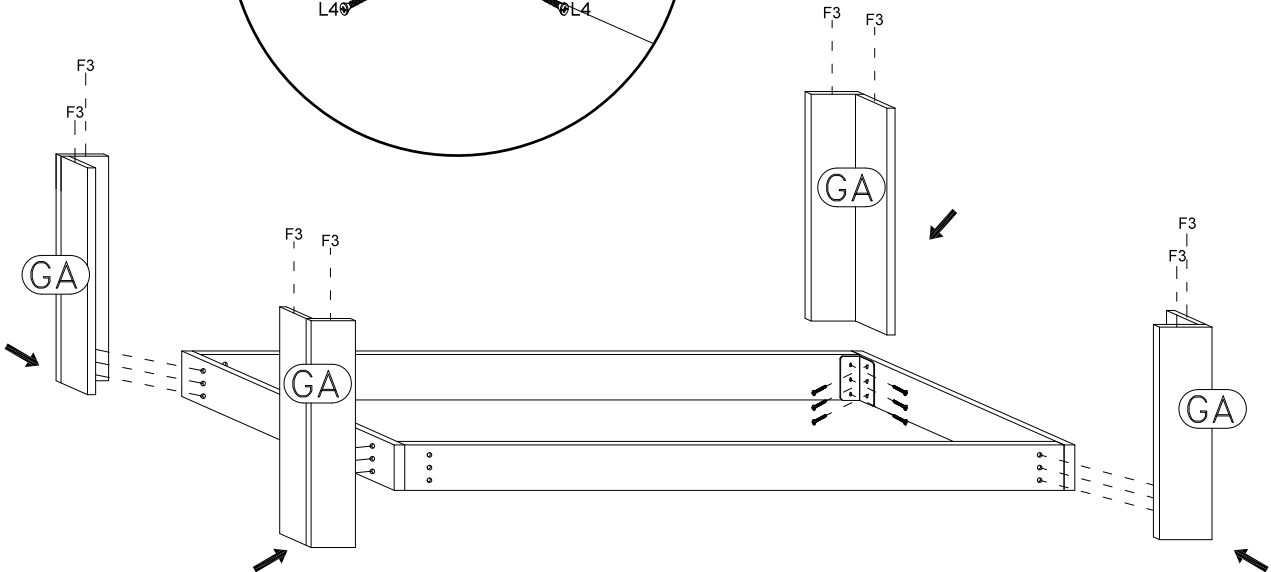
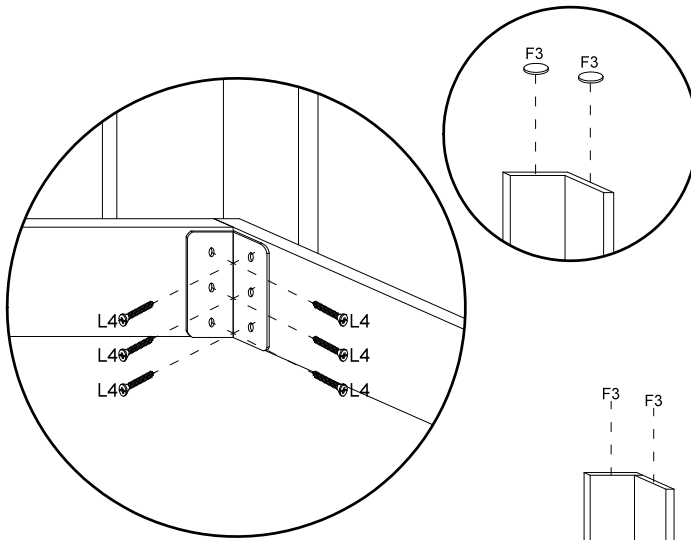

3

