

- (D) Montageanleitung
- (NL) Handleiding voor de montage
- (HU) Szerelési útmutató
- (GB) Assembly instructions
- (PL) Instrukcja montażu

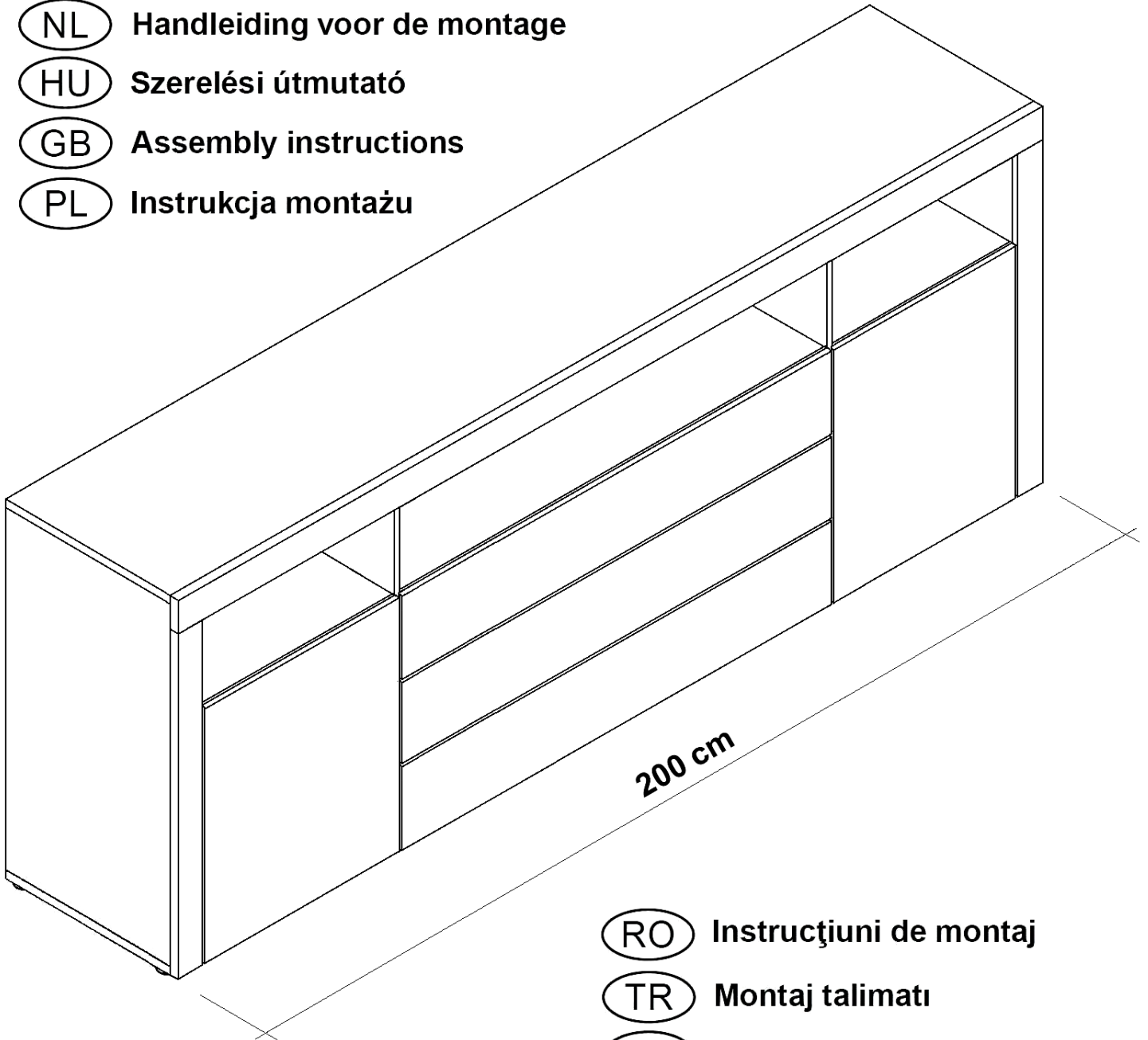

- (FR) Notice de montage
- (CZ) Montážní návod
- (RO) Instrucțiuni de montaj
- (TR) Montaj talimatı
- (IT) Istruzioni di montaggio
- (SK) Návod na montáž
- (RU) Инструкция по монтажу

**Service • Assistenza • Dienstverlening • Servis  
Servis • Szerviz • Сервисная служба**

Name • Nom • Nome • Naam •  
Nazwa • Jméno • Názov • Név •  
Denumire • Ísím • Название

Nr. • No. • N° • Номер • Č • Sz

Typ • Type • Tip • Típus • Тиро •  
Тип

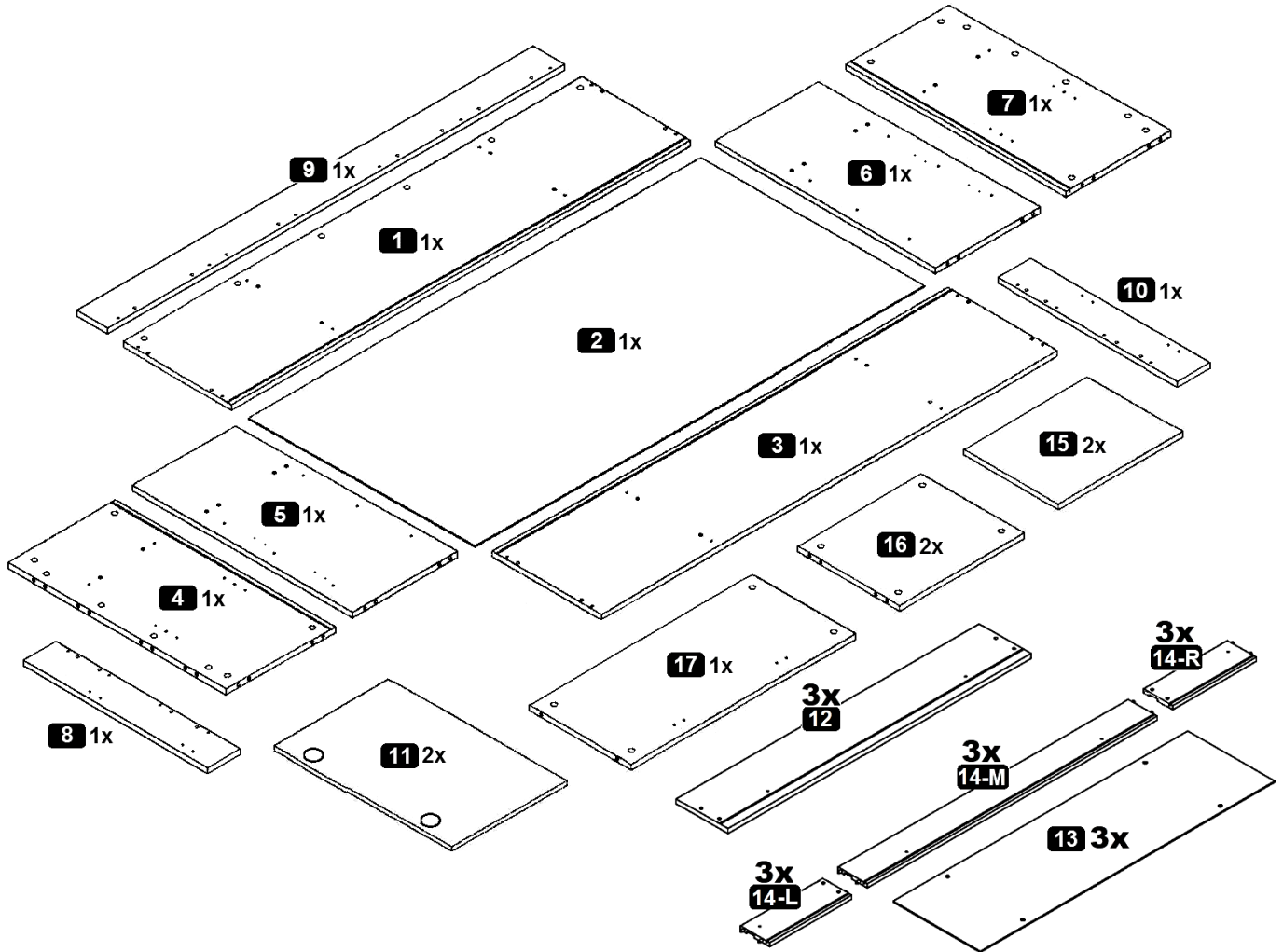
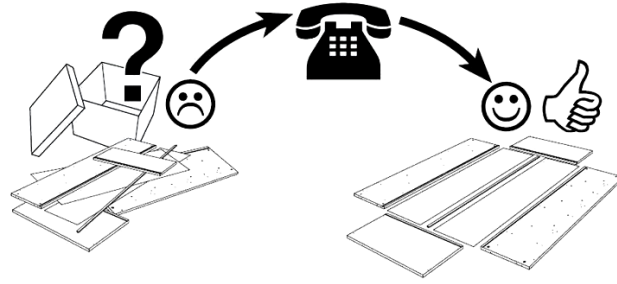
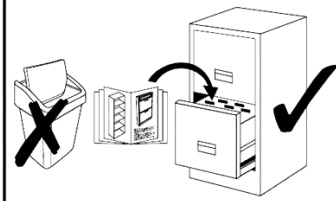



<b>1</b>	1x	ca. 2002 x 330 mm	<b>6</b>	1x	ca. 668 x 315 mm	<b>11</b>	2x	ca. 398 x 476 mm	<b>14-R</b>	3x	ca. 310 x 104 mm
<b>2</b>	1x	ca. 1981 x 680 mm	<b>7</b>	1x	ca. 668 x 330 mm	<b>12</b>	3x	ca. 1074 x 156 mm	<b>15</b>	2x	ca. 437 x 300 mm
<b>3</b>	1x	ca. 2002 x 330 mm	<b>8</b>	1x	ca. 639 x 60 mm	<b>13</b>	3x	ca. 1044 x 307 mm	<b>16</b>	2x	ca. 437 x 315 mm
<b>4</b>	1x	ca. 668 x 330 mm	<b>9</b>	1x	ca. 2002 x 60 mm	<b>14-L</b>	3x	ca. 310 x 104 mm	<b>17</b>	1x	ca. 1065 x 315 mm
<b>5</b>	1x	ca. 668 x 315 mm	<b>10</b>	1x	ca. 639 x 60 mm	<b>14-M</b>	3x	ca. 1032 x 104 mm			

<b>A</b>	8,0 x 30 mm	<b>B</b>	34x	<b>C</b>	42x	<b>D</b>	3,9x9,5mm	<b>E</b>	8x	<b>F</b>	12x	<b>G</b>	1x
<b>H</b>	4x	<b>I</b>	8x	<b>J</b>	4,0 x 20 mm	<b>K</b>	2,7 x 20 mm	<b>L</b>	27 x 310 mm	<b>M</b>	6,3 x 13 mm	<b>N</b>	M4,0 x 9 mm
<b>O</b>	80 mm												



# 1



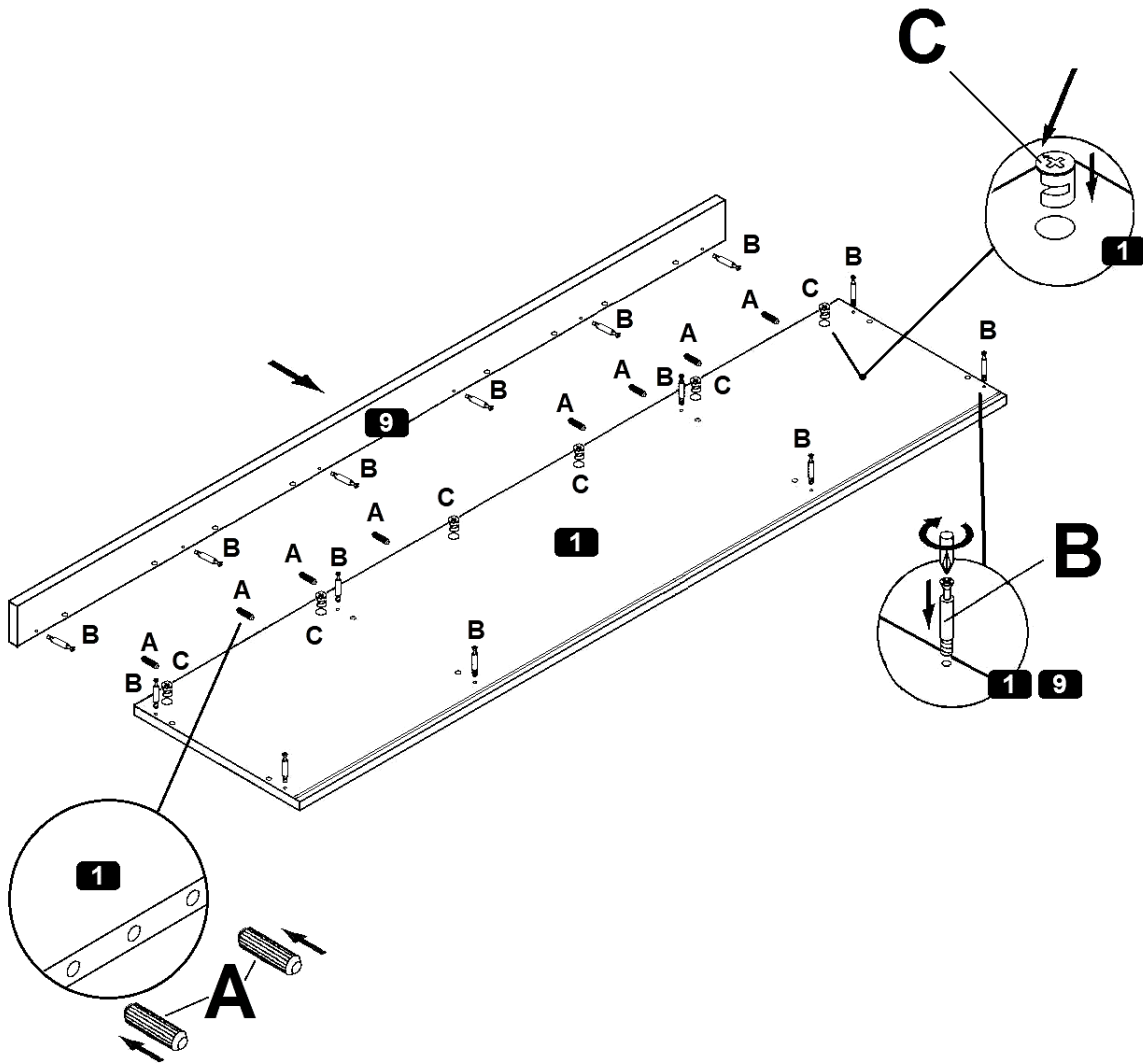
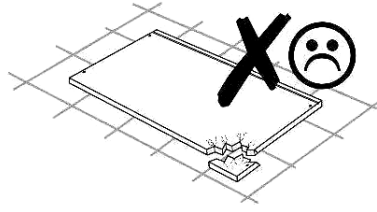
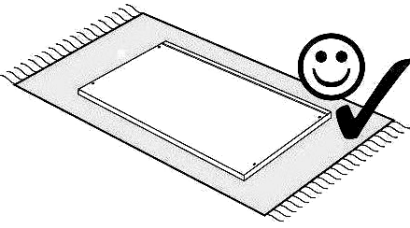
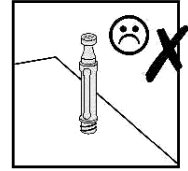
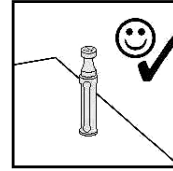

<b>A</b> 8,0 x 30 mm	<b>B</b>	<b>C</b>
 8x	 14x	 6x

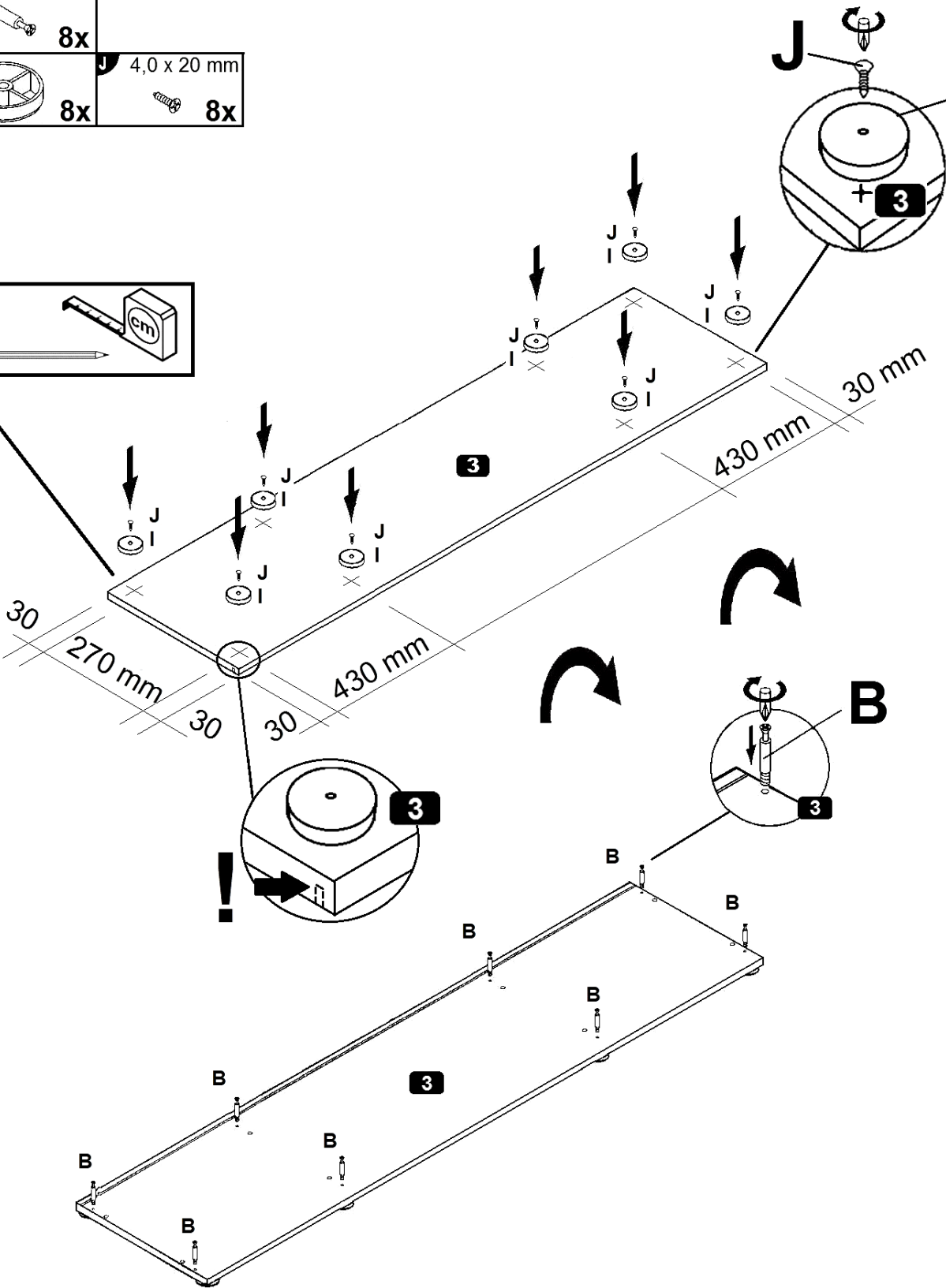
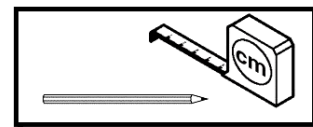
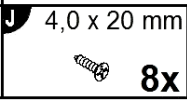
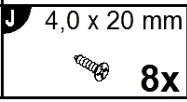
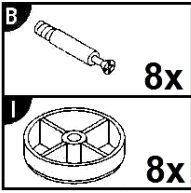
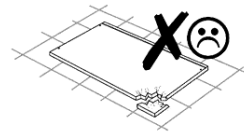
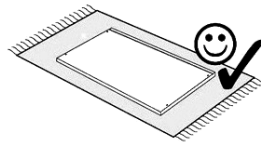
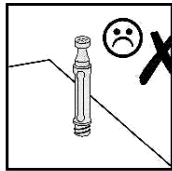
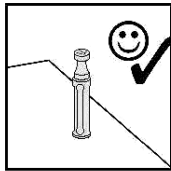

**2**







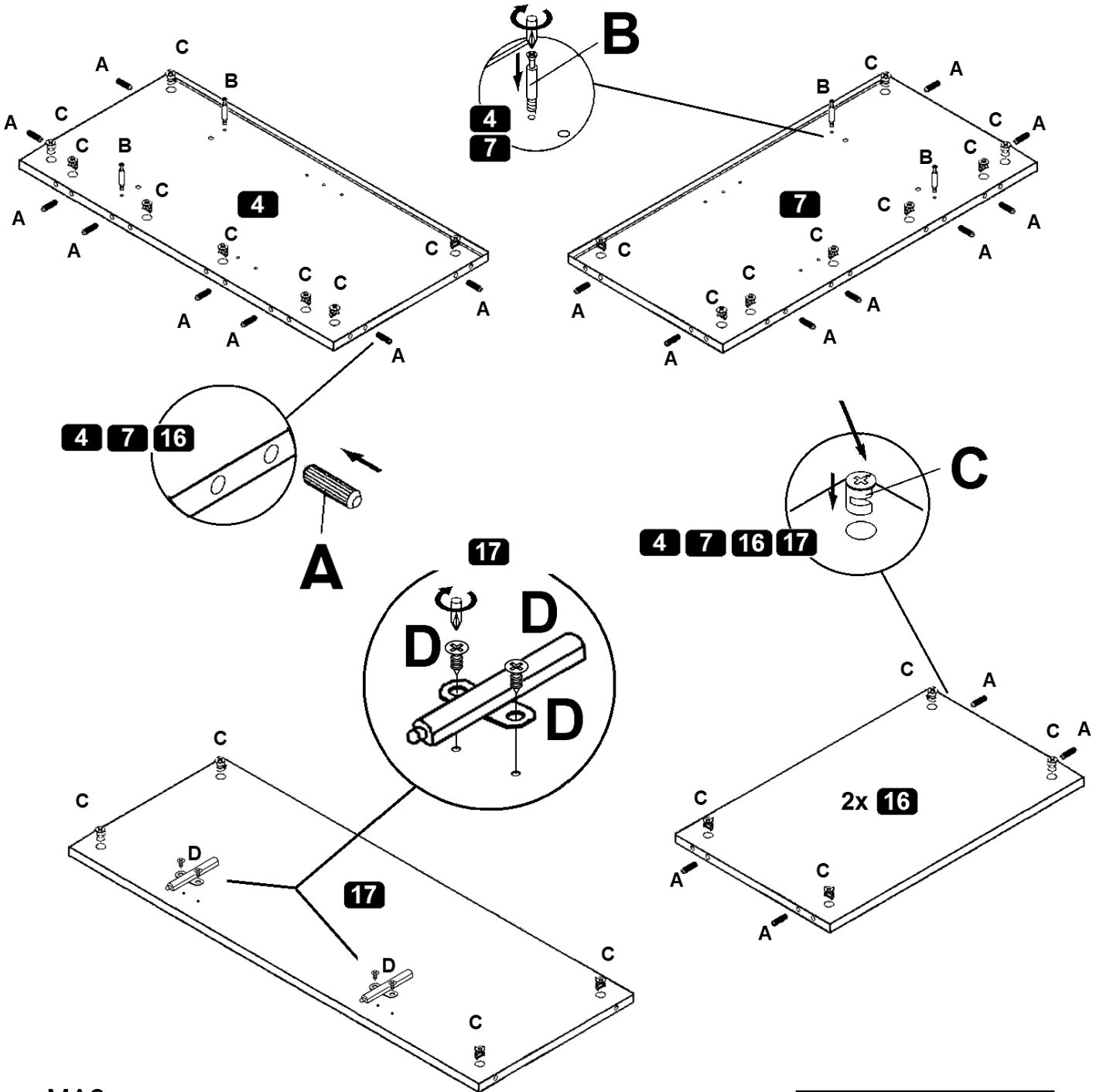
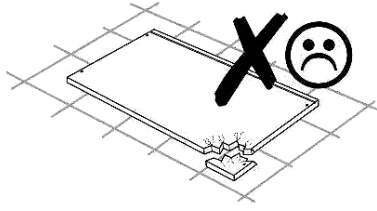
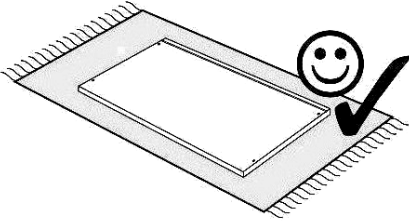
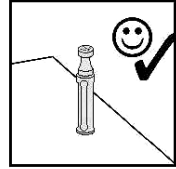
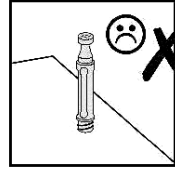

# 3

<b>A</b> 8,0 x 30 mm  24x	<b>B</b>  4x	<b>C</b>  28x	<b>D</b> 3,9x9,5mm  2x
--	---	--	---



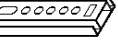

# 4

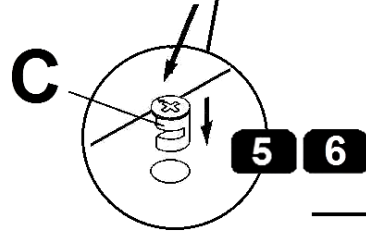
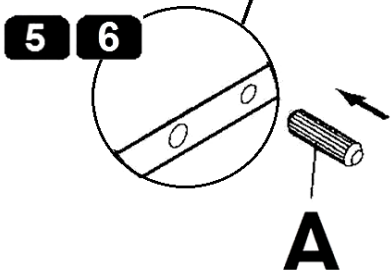
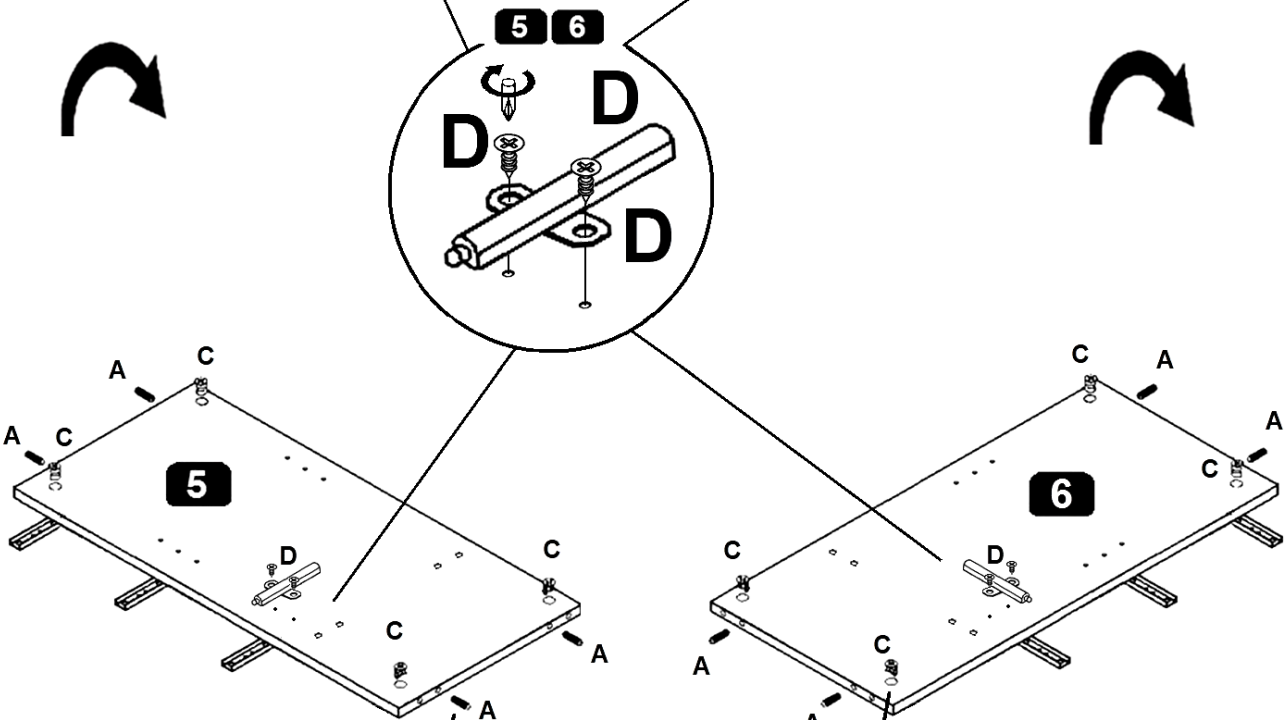
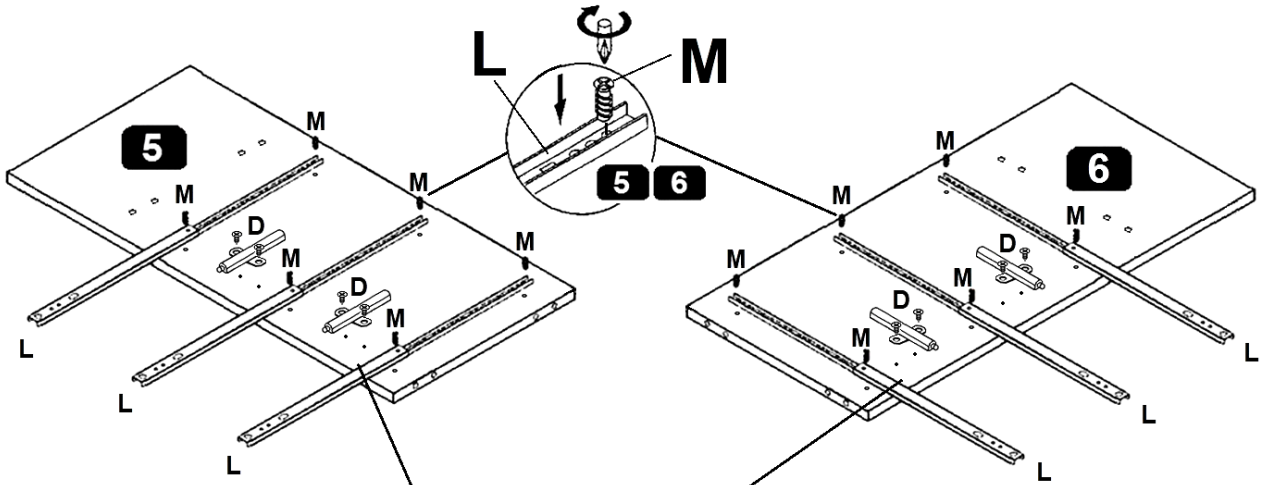
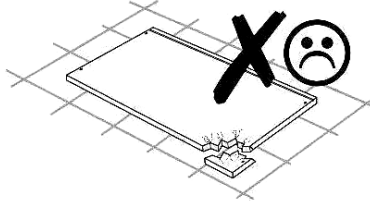
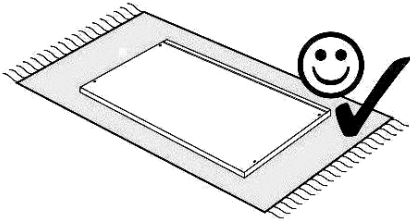
<b>A</b> 8,0 x 30 mm	<b>C</b>  8x	<b>D</b>  3,9x9,5mm	<b>L</b> 27 x 310 mm	<b>M</b> 6,3 x 13 mm
 8x	 8x	 6x	 6x	 12x

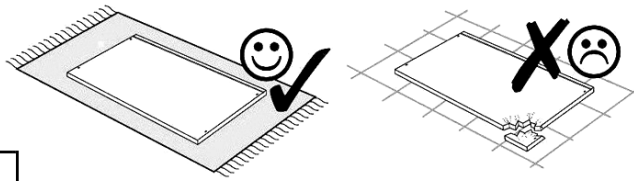

# 5

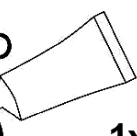

M	6,3 x 13 mm	F		12x
G				1x
D Leim GB Glue FR Colle IT Colla NL Lijm PL Klej CZ Lepidlo SK Glej HU Enyv RO Adeziv TR Tutkal RU Клей				

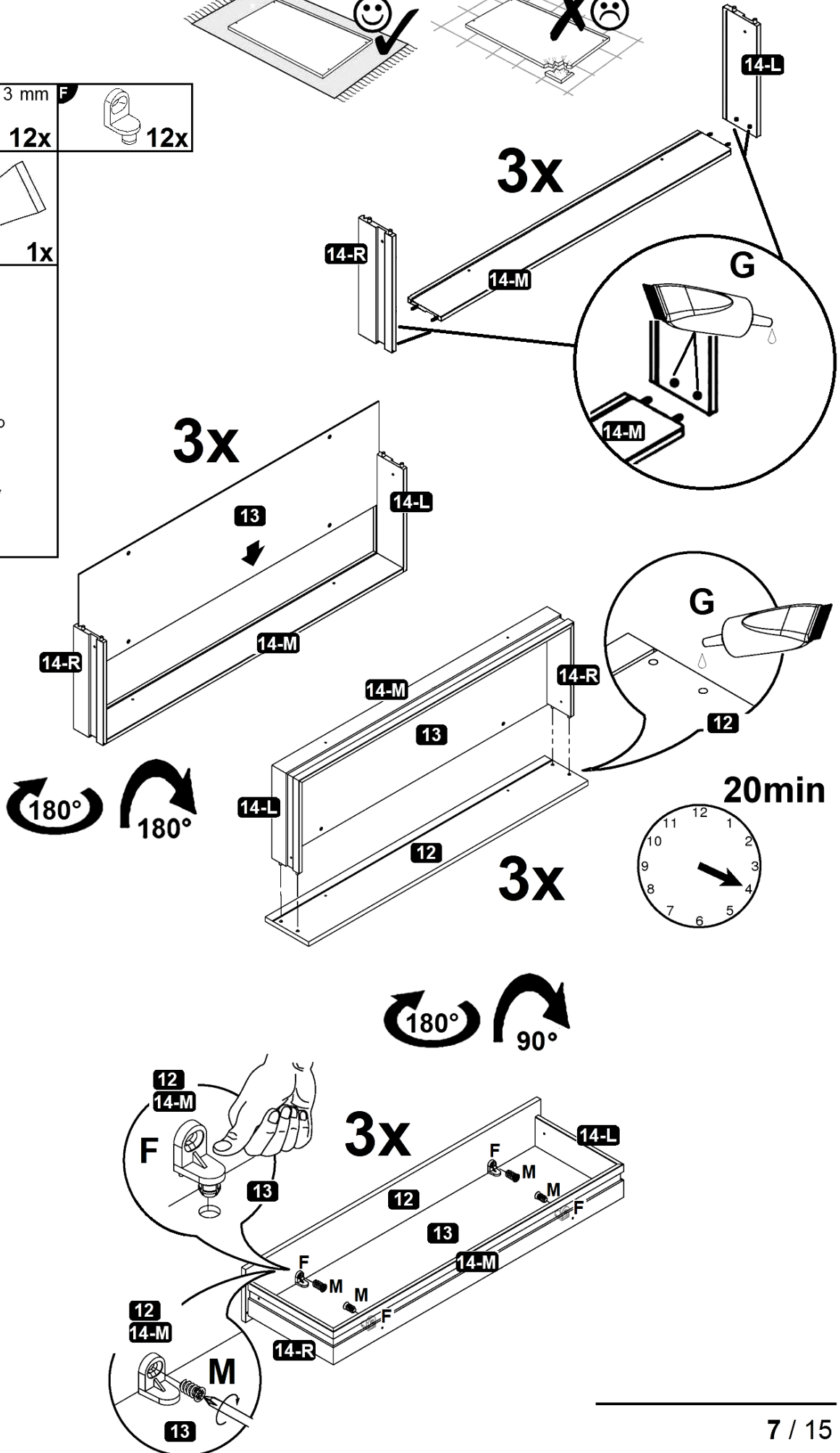

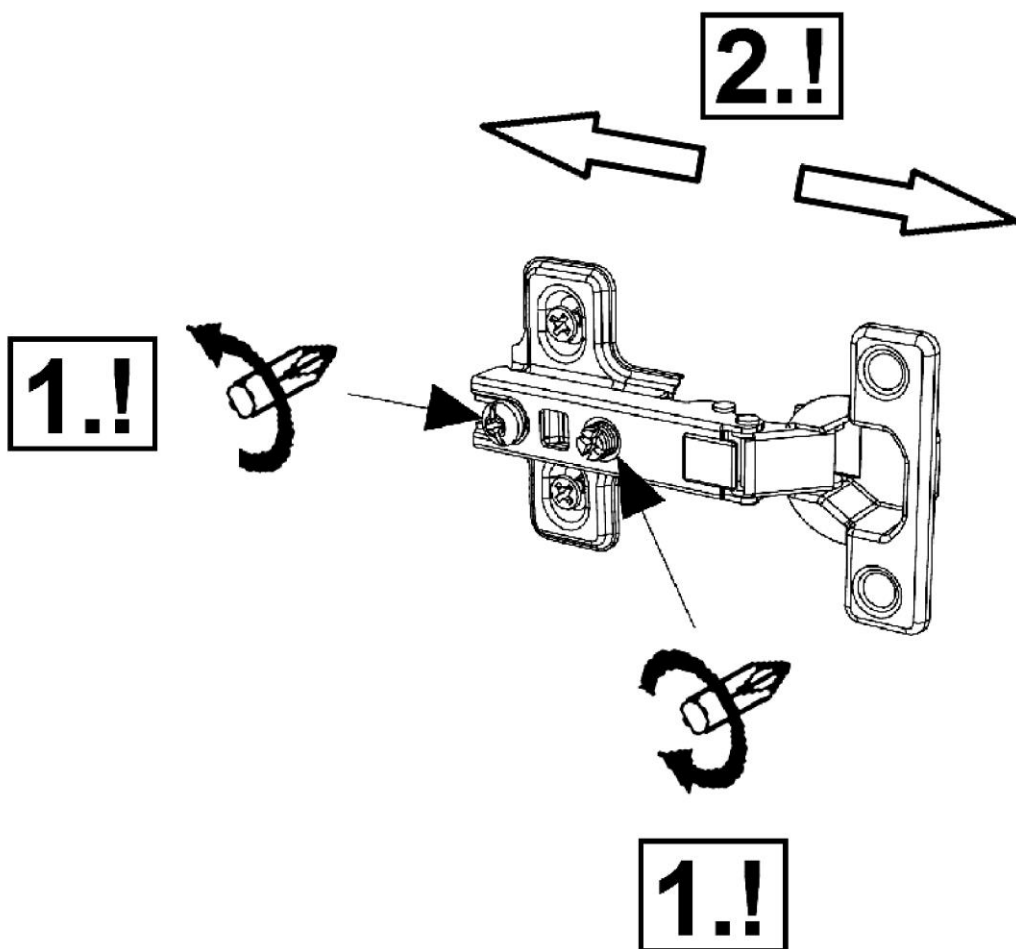



# 6

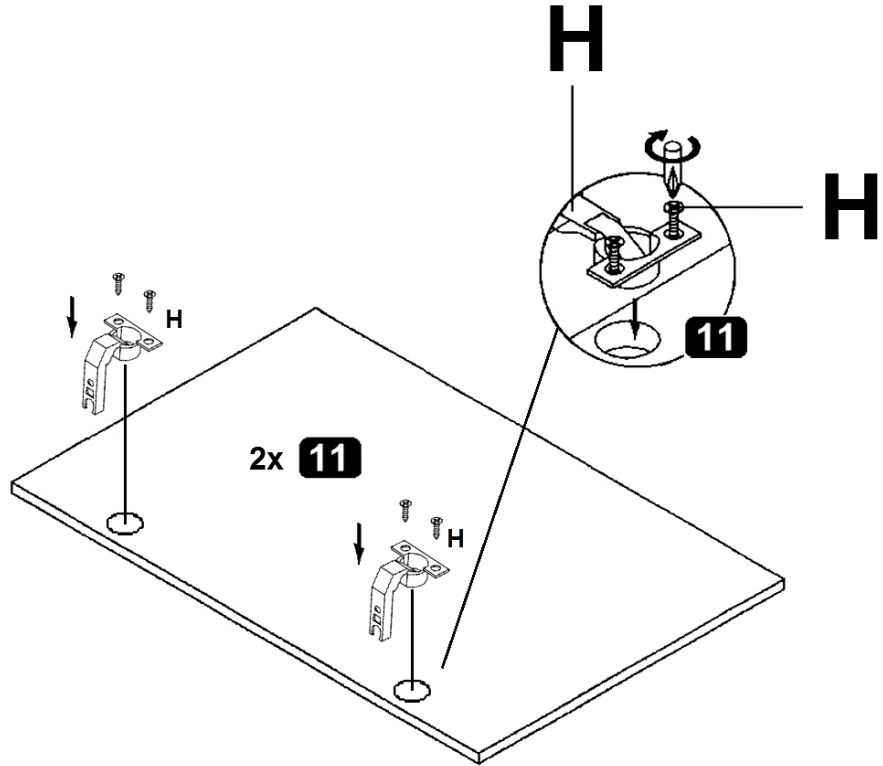
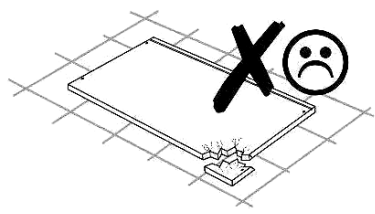
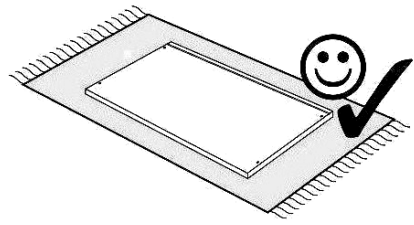
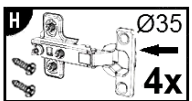

# 7

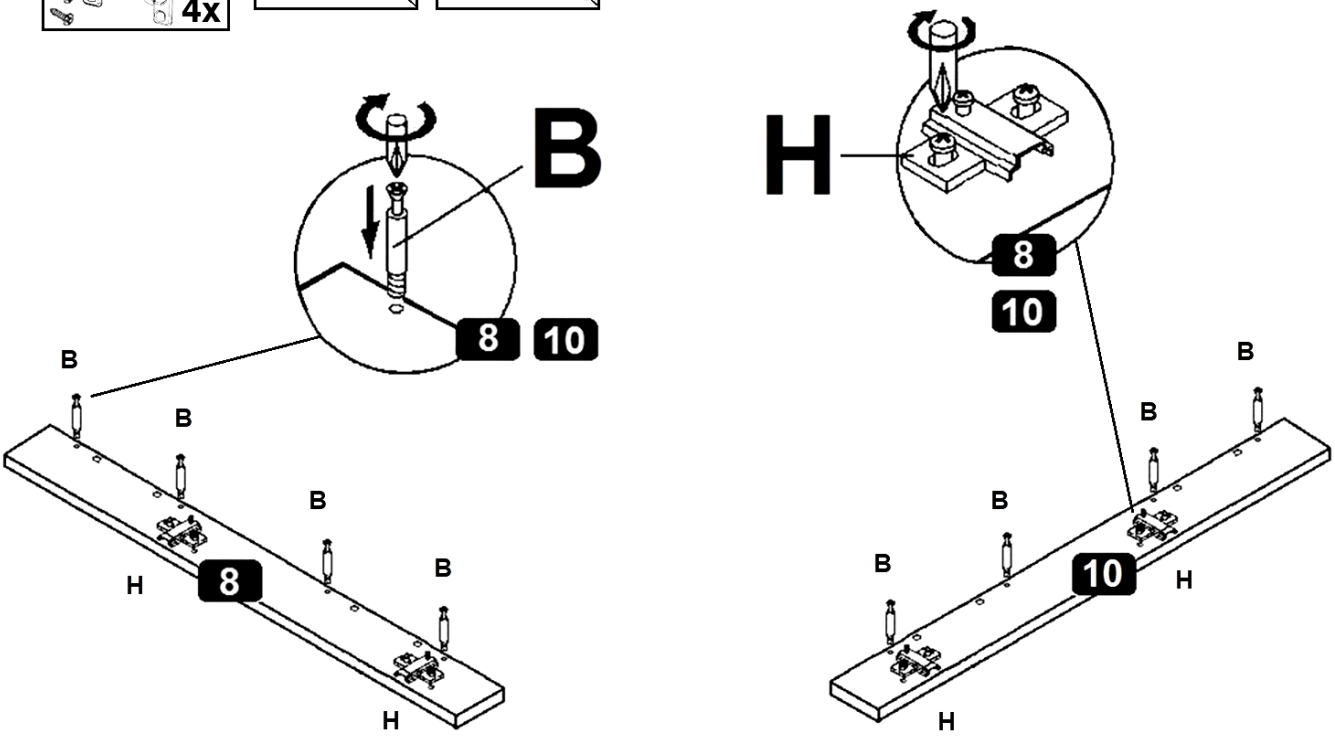
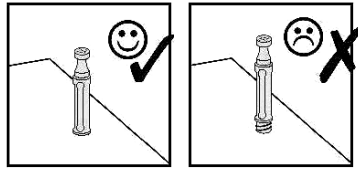
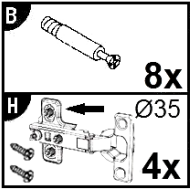

# 8

80 mm  
4x

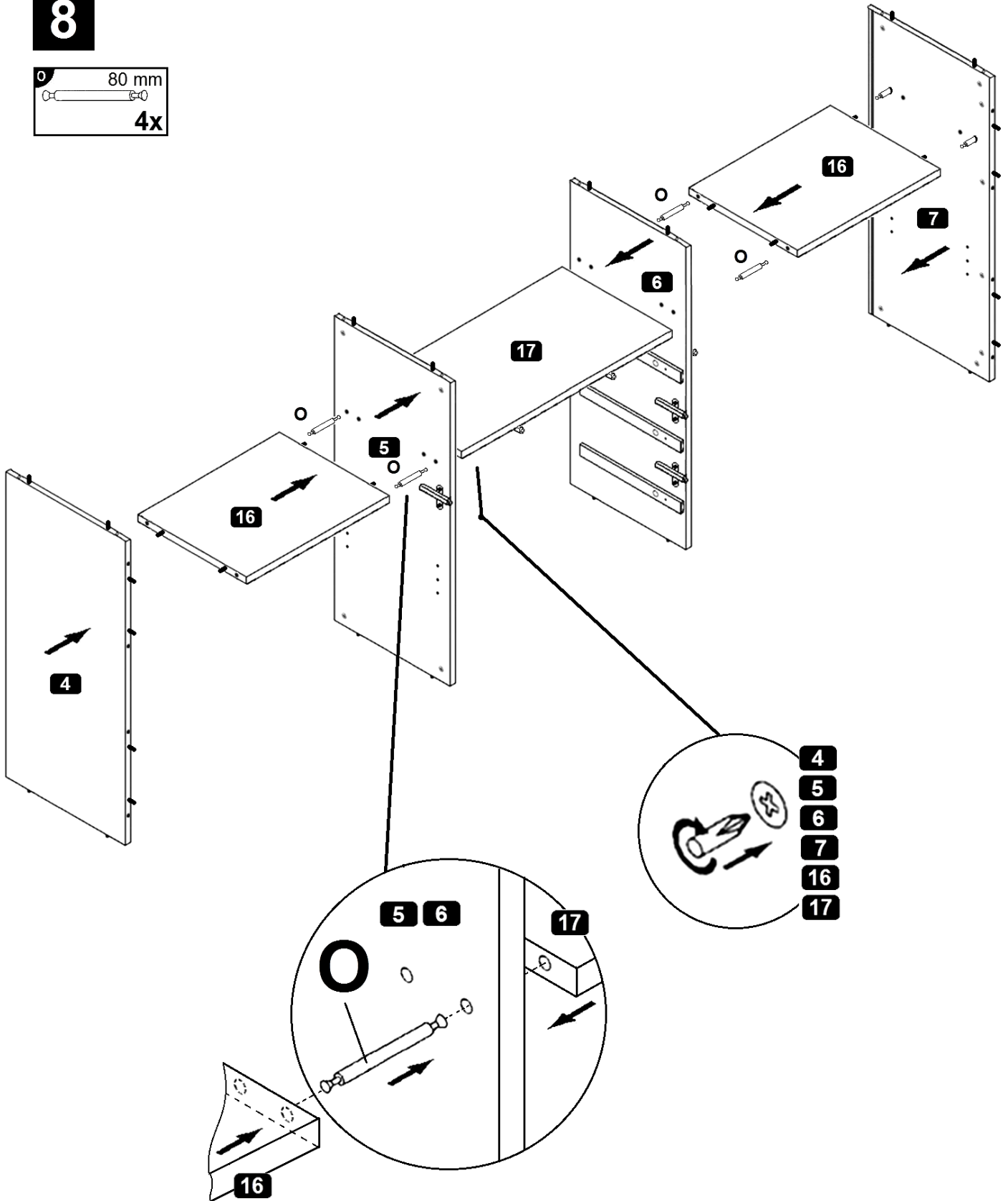

9

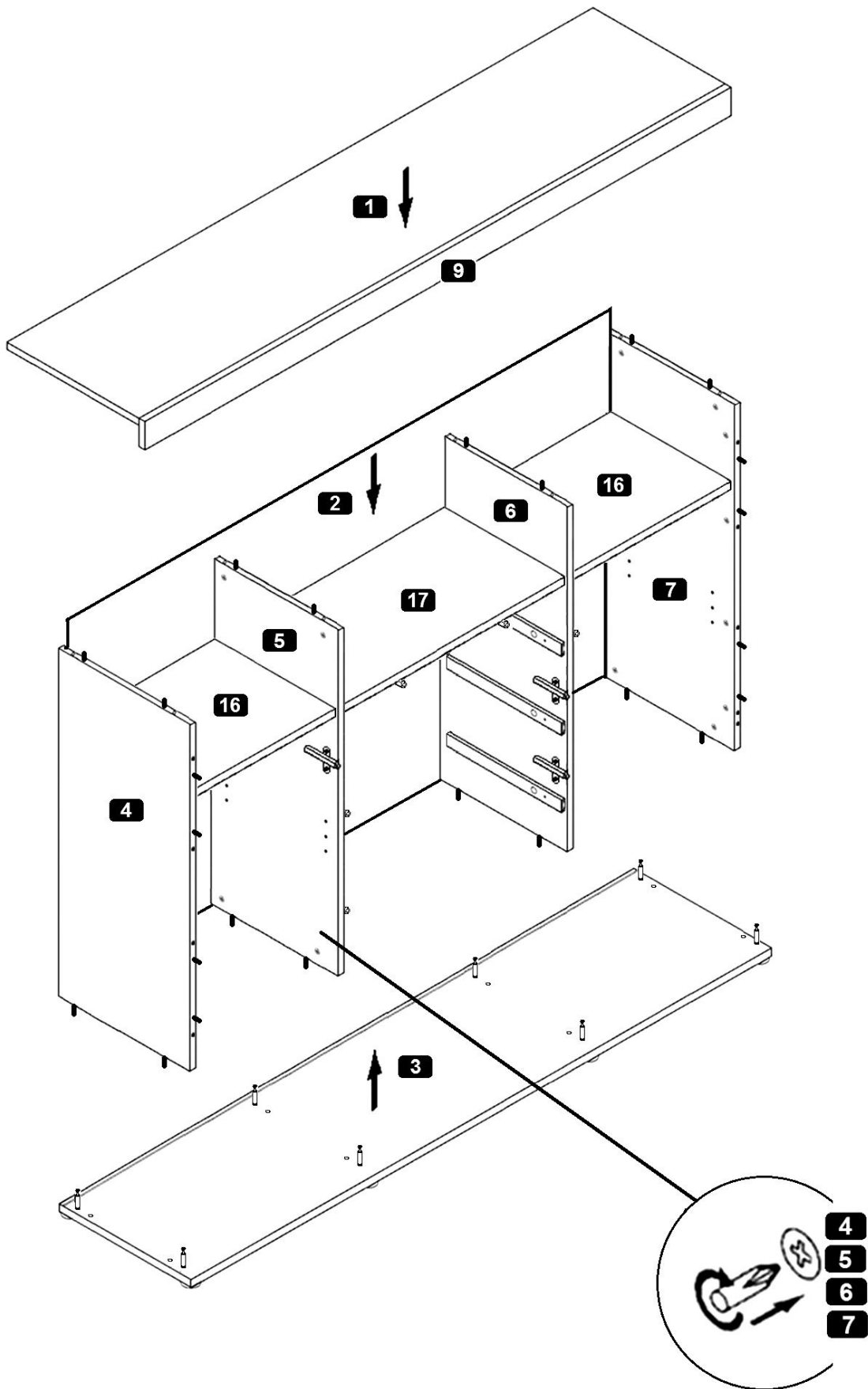

# 10

K	2,7 x 20 mm
	12x
N	M4,0 x 9 mm
	6x
E	
	8x

# 1.!

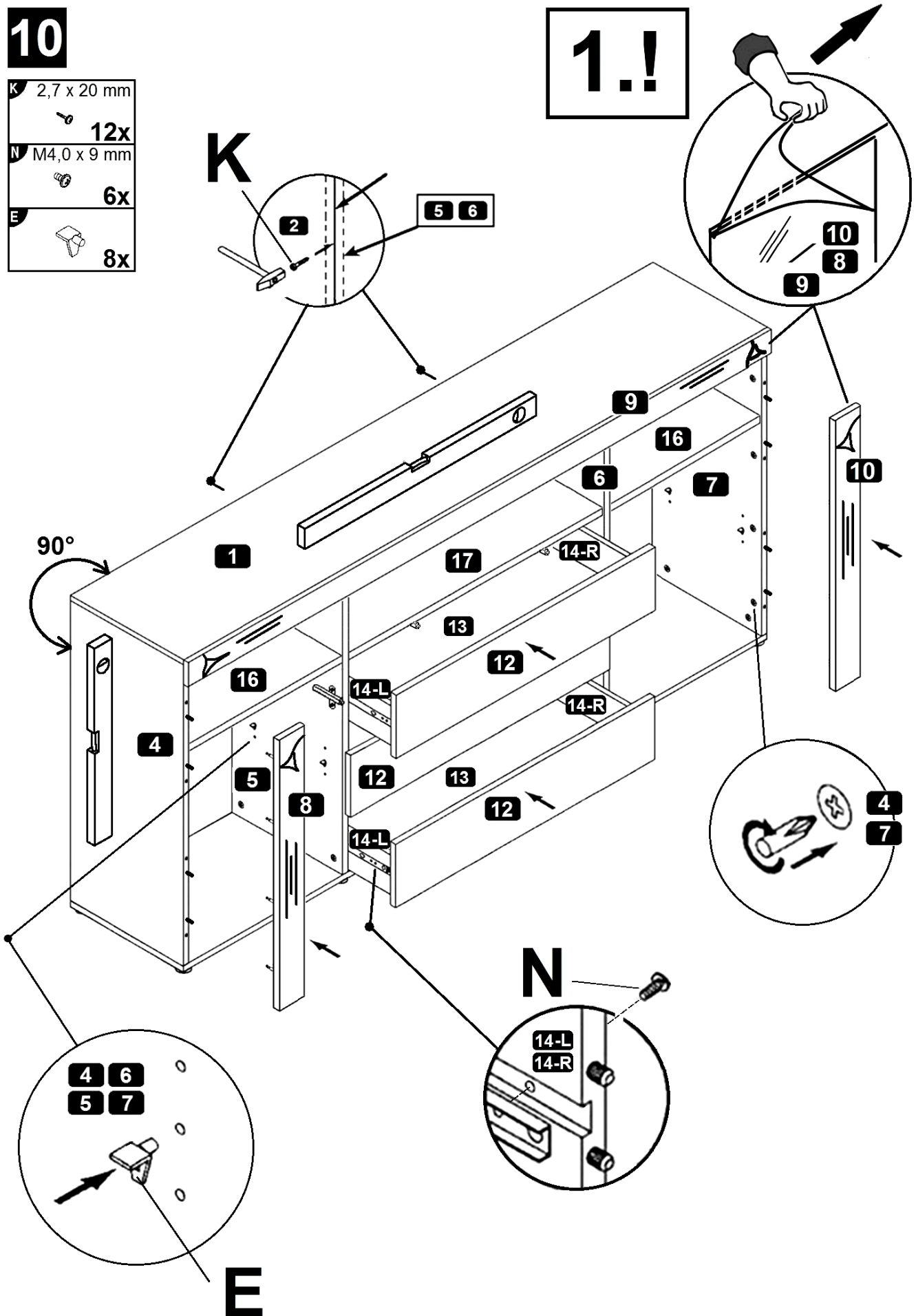

# 11

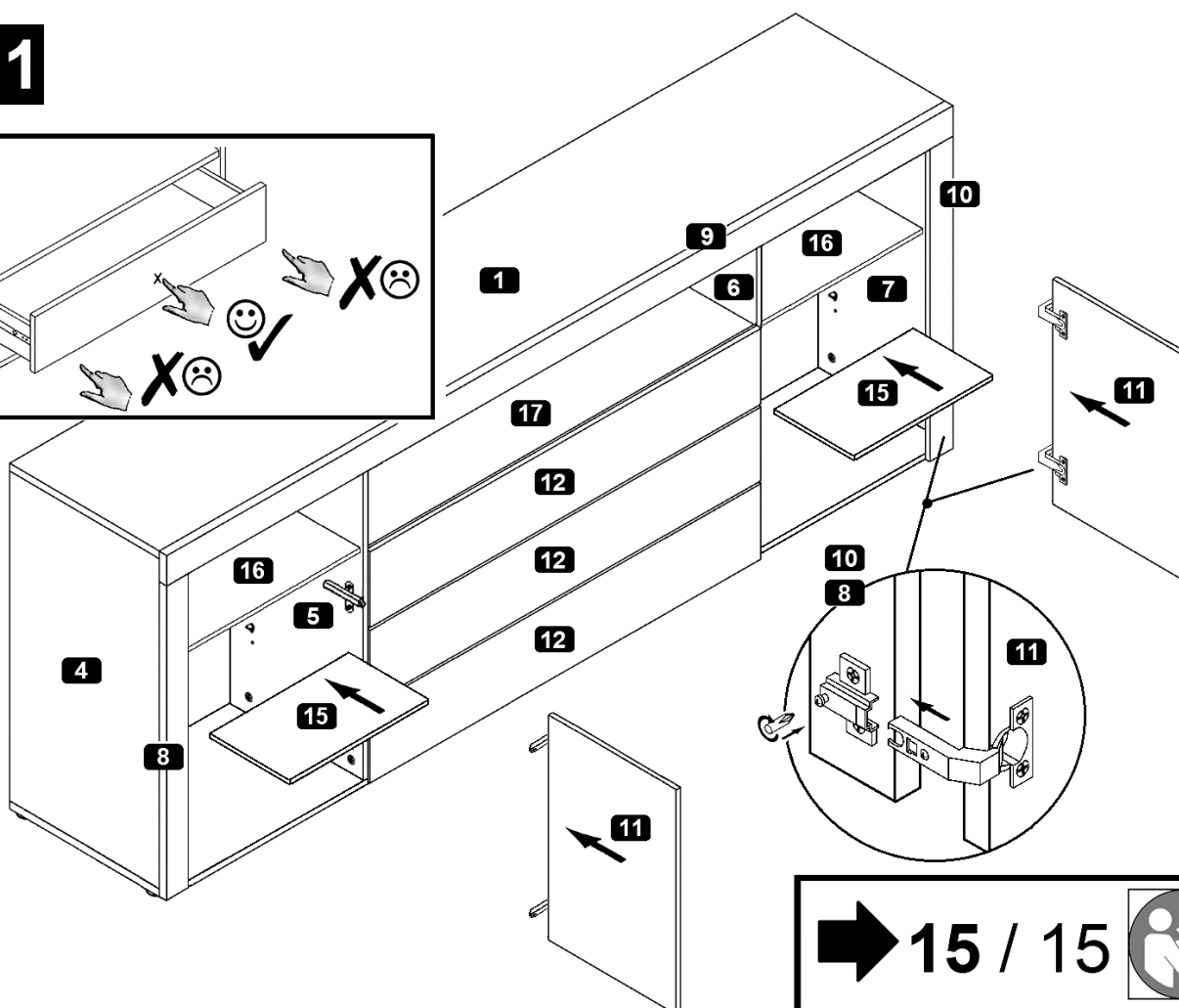
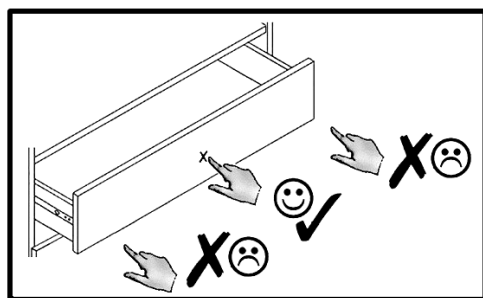



**➔ 14 / 15**

(D) Push-To-Open einstellen  
 (GB) Adjusting the Push-To-Open  
 (FR) Régler les Push-To-Open  
 (IT) Sistemare Push-To-Open  
 (NL) Push-To-Open instellen  
 (PL) Nastawić Push-To-Open  
 (CZ) Vyrovnajte Push-To-Open  
 (RO) Nastavenie Push-To-Open  
 (HU) Állítsa be az ajtókat  
 (SK) Reglare Push-To-Open  
 (TR) Push-To-Open ayarlanması  
 (RU) Регулировка Push-To-Open

**➔ 15 / 15**

(D) Türen einstellen  
 (Scharniere justieren)  
 (GB) Adjusting the doors  
 (adjusting the hinges)  
 (FR) Régler les portes  
 (ajuster les charnières)  
 (IT) Sistemare le porte  
 (regolare le cerniere)  
 (NL) Deuren instellen  
 (scharnieren afstellen)  
 (PL) Nastawić drzwi  
 (wyregulować zawiasy)  
 (CZ) Vyrovnajte dvířka  
 (seřid'te závěsy)  
 (RO) Nastavenie dverí  
 (nastavenie závesov)  
 (HU) Állítsa be az ajtókat  
 (állítsa be a zsanérokát)  
 (SK) Reglare uši  
 (ajustare balamale)  
 (TR) Kapıların ayarlanması  
 (menteselerin seviye ayarı)  
 (RU) Регулировка дверей  
 (регулировка шарнира)

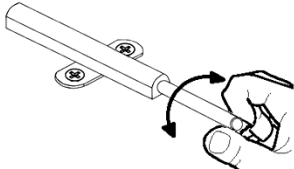
12

		
<b>(D)</b> Push-To-Open einstellen	<b>(CZ)</b> Vyrovnajte Push-To-Open	
<b>(GB)</b> Adjusting the Push-To-Open	<b>(RO)</b> Nastavenie Push-To-Open	
<b>(FR)</b> Régler les Push-To-Open	<b>(HU)</b> Állítsa be az Push-To-Open	
<b>(IT)</b> Sistemare Push-To-Open	<b>(SK)</b> Reglare Push-To-Open	
<b>(NL)</b> Push-To-Open instellen	<b>(TR)</b> Push-To-Open ayarlanması	
<b>(PL)</b> Nastawić Push-To-Open	<b>(RU)</b> Регулировка Push-To-Open	

1.

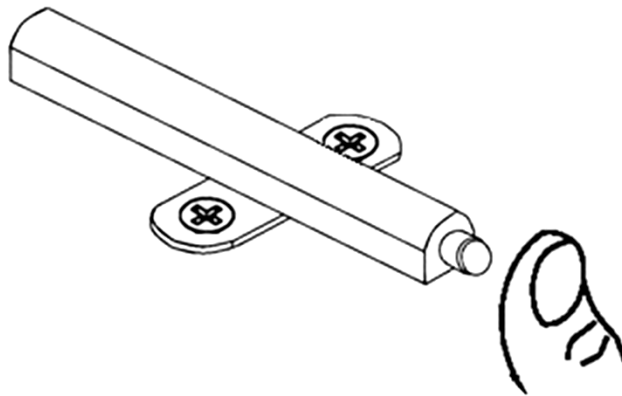

2.

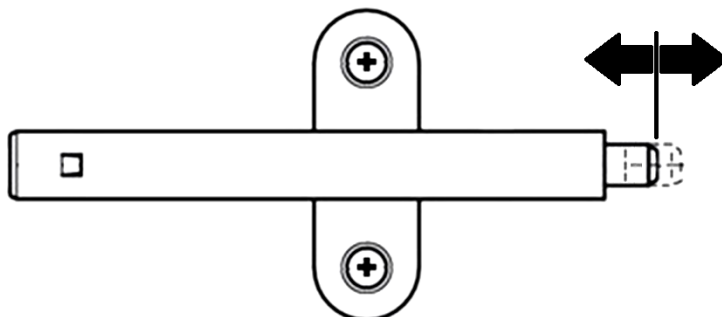
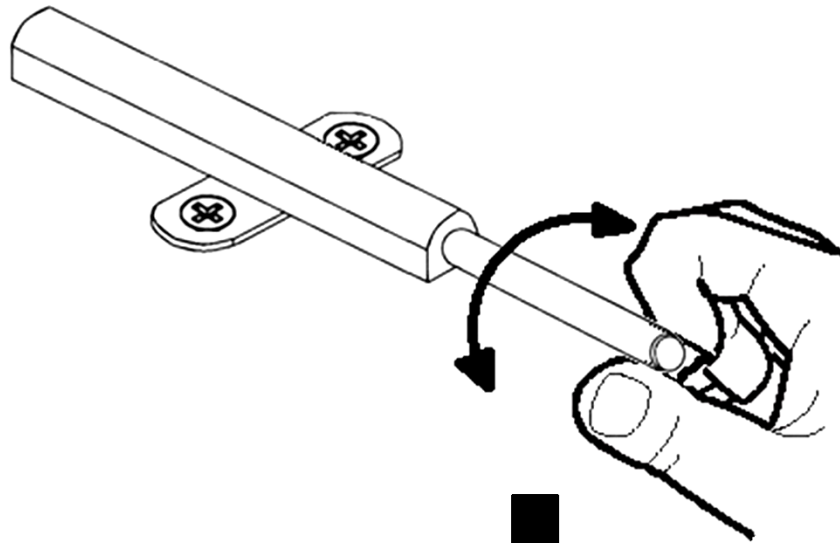

13

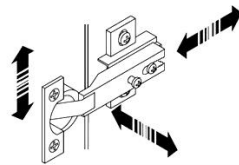

(D) Türen einstellen  
(Scharniere justieren)

(GB) Adjusting the doors  
(adjusting the hinges)

(FR) Régler les portes  
(ajuster les charnières)

(IT) Sistemare le porte  
(regolare le cerniere)

(NL) Deuren instellen  
(scharnieren afstellen)

(PL) Nastawić drzwi  
(wyregulować zawiasy)

(CZ) Vyrovnajte dvířka  
(seřid'te závěsy)

(RO) Nastavenie dverí  
(nastavenie závesov)

(HU) Állítsa be az ajtókat  
(állítsa be a zsanérokot)

(SK) Reglare uši  
(ajustare balamale)

(TR) Kapıların ayarlanması  
(menteşelerin seviye ayarı)

(RU) Регулировка дверей  
(регулировка шарнира)

