

Vertiko - Vertical

Montage

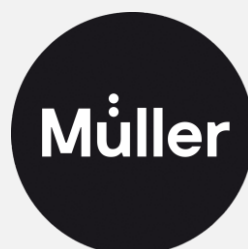

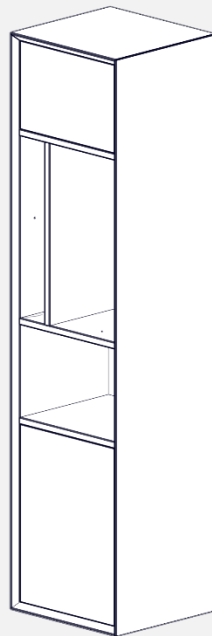

Vertiko - Vertical

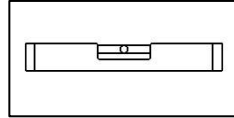
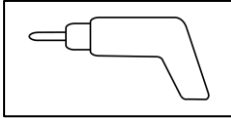
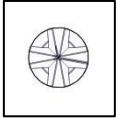

BSCH-0132
x2

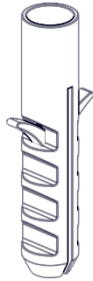

BSCH-0125
x2



ZDIV-0758
x2



ZDIV-0584
x2

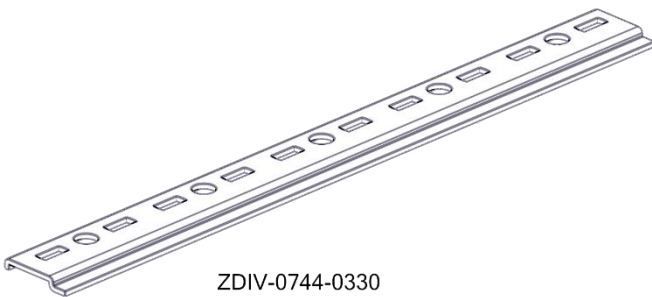

ZDIV-0744-0330



Deutsch

Grundsätzlich müssen zur wandseitigen Montage Befestigungsbeschläge benutzt werden, die für die heimischen Wände geeignet sind. Sollten Fragen bestehen, holen Sie sich fachlichen Rat ein. Der beige packte Dübel ist für folgende Wände geeignet: Beton, Vollziegel, Kalksandvollstein, Porenbeton, Hochlochziegel, Kalksandlochstein, Gipsbauplatte, Gipskarton- und Gipsfaserplatte, Hohlblocksandstein aus Leichtbeton, Hohldecken aus Ziegel, Spannbetonhohldecken, Naturstein, Spanplatten, Vollgips-Platten, Vollstein aus Leichtbeton.

Wenn mehrere Vertikos gestapelt werden sollen, müssen alle Elemente separat an der Wand montiert werden!!

English

In principle, specific fastening fittings must be used for wall-side installation, which are suitable for the specific walls at your home. If you have any questions, seek professional advice. The enclosed dowel is suitable for the following walls: concrete, solid brick, solid sand-lime brick, aerated concrete, vertically perforated brick, sand-lime perforated brick, gypsum wallboard, gypsum plasterboard and gypsum fiber board, hollow block sandstone made of lightweight concrete, hollow core slabs made of brick, prestressed concrete hollow slabs, natural stone, chipboard, solid gypsum panels, solid stone made of lightweight concrete. If several Vertikos are to be stacked, all elements must be attached to the wall separately!!

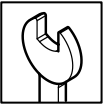

1

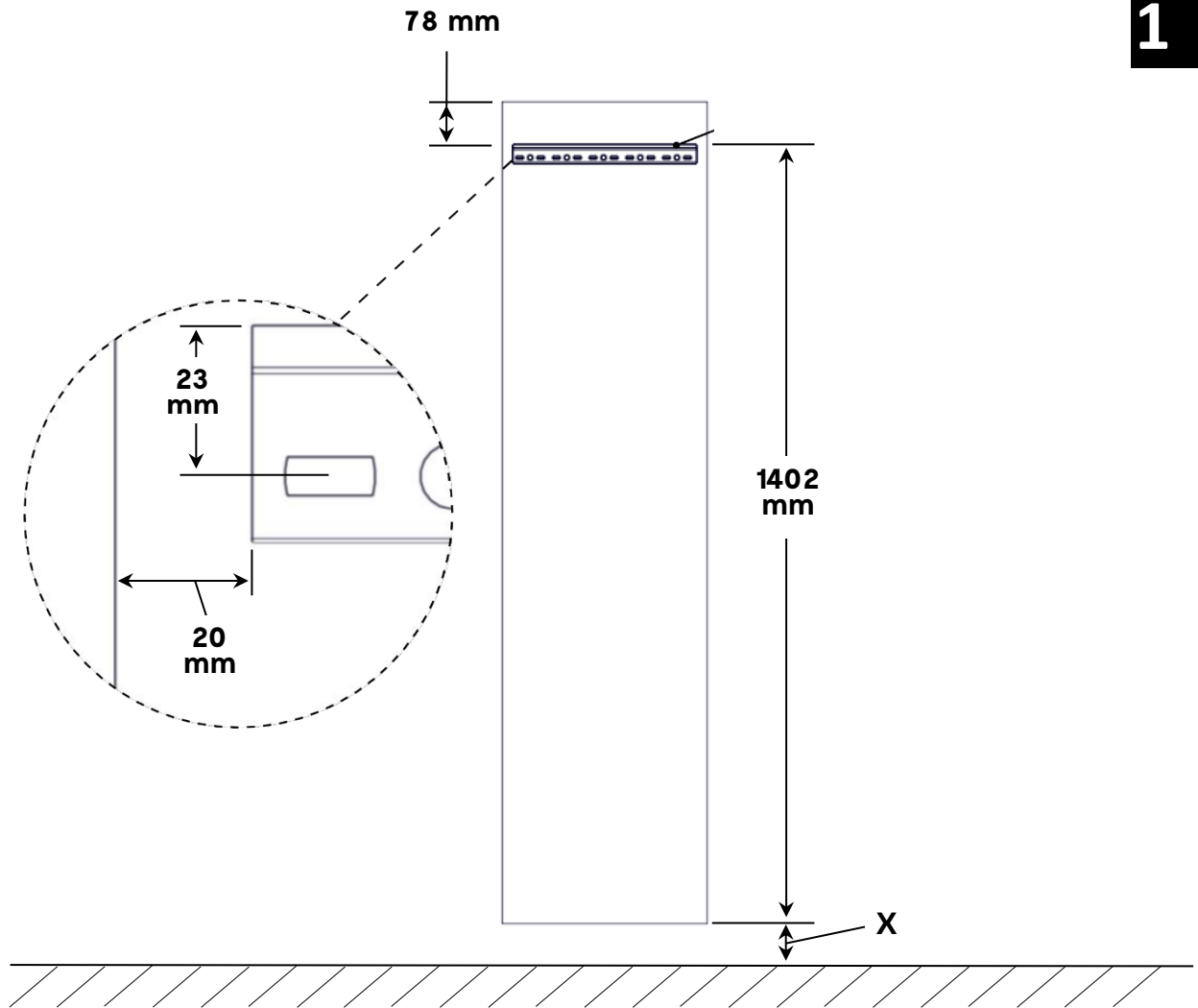

Deutsch

Abstand Boden – Oberkante Montageschiene (ZDIV-0744-1440)

$$= X + 1402 \text{ mm}$$

Abstand Boden – Oberkante Vertiko Wide

$$= X + 1402 \text{ mm} + 78 \text{ mm}$$

English

Distance bottom – top edge mounting rail (ZDIV-0744-1440)

$$= X + 1402 \text{ mm}$$

Distance bottom – top edge Vertiko Wide

$$= X + 1402 \text{ mm} + 78 \text{ mm}$$

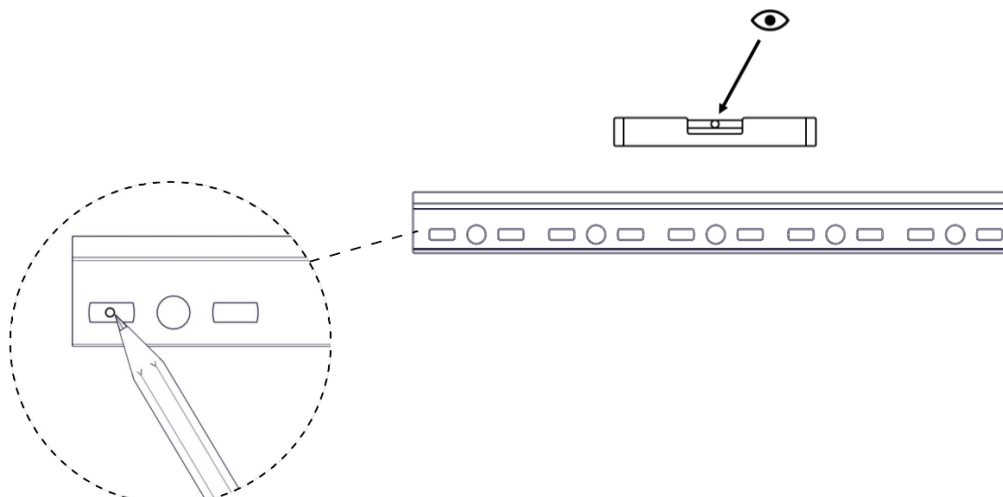



Vertiko - Vertical

2

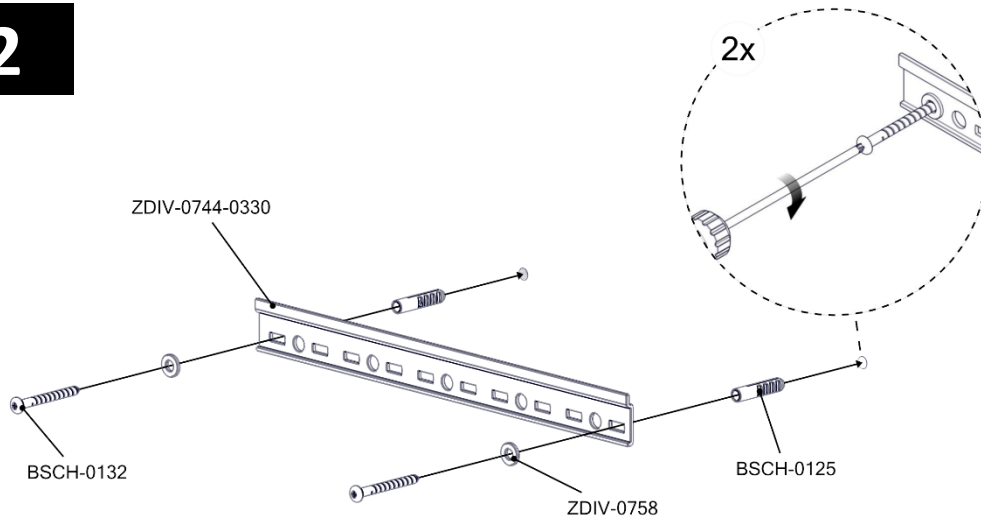

3

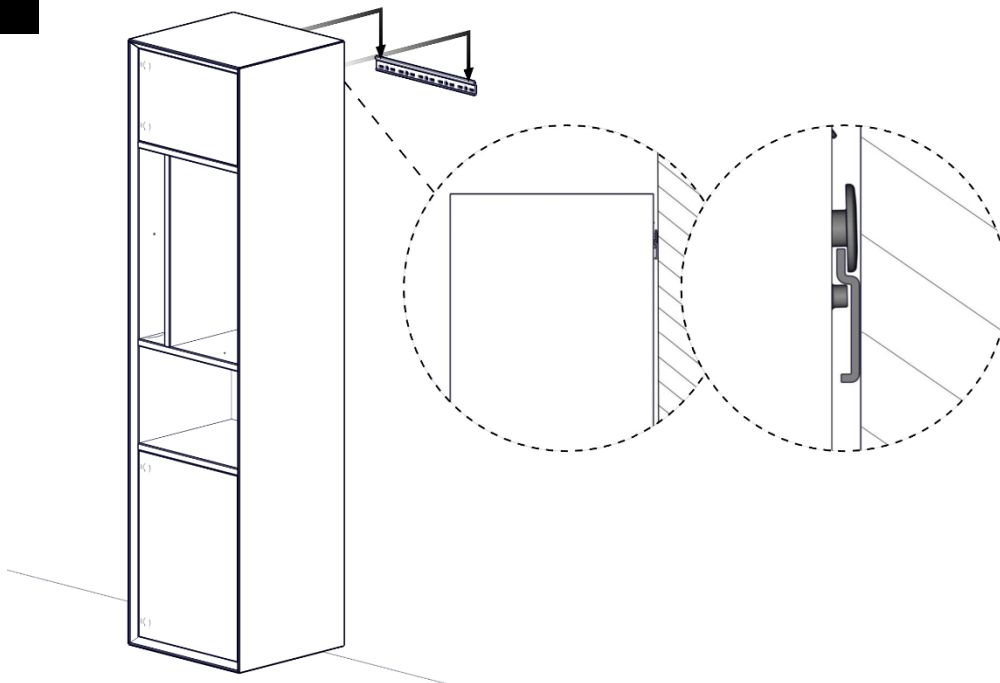

4

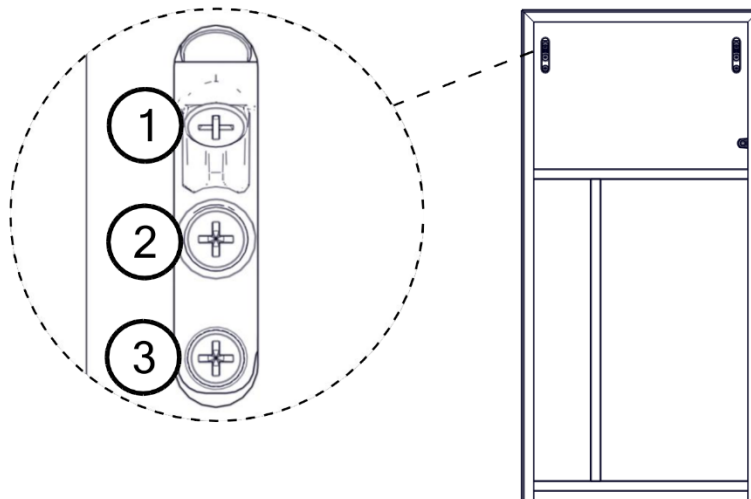

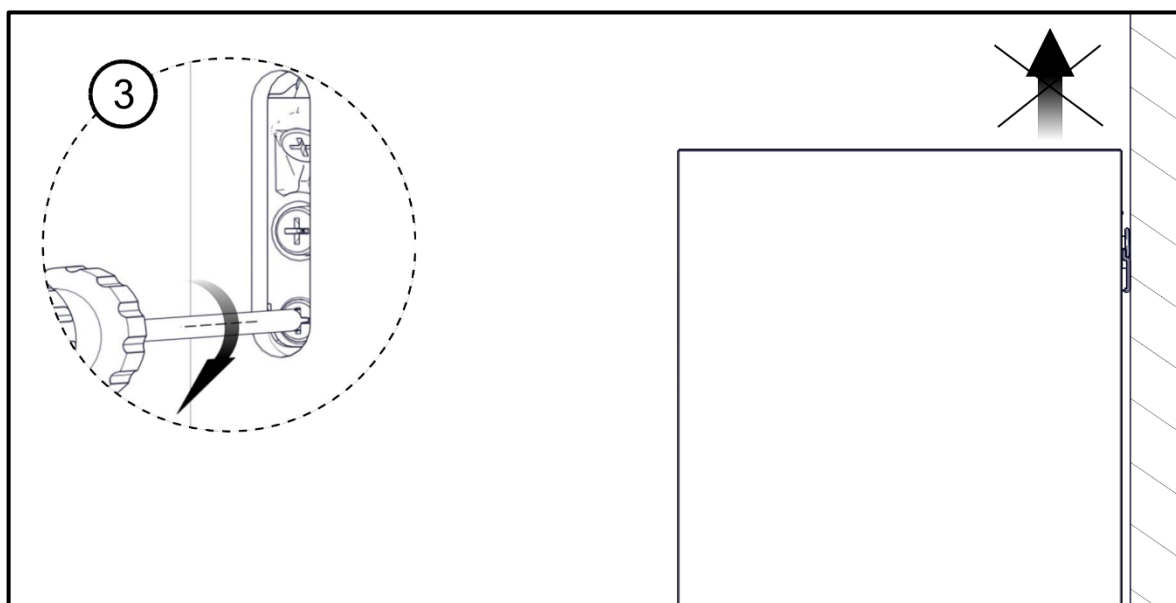
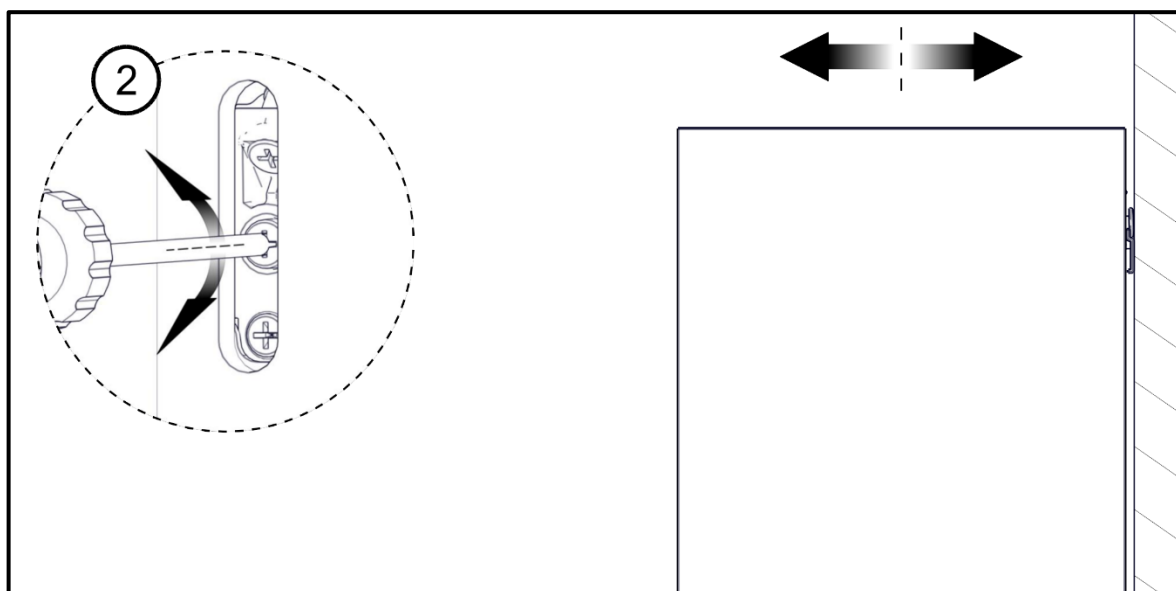
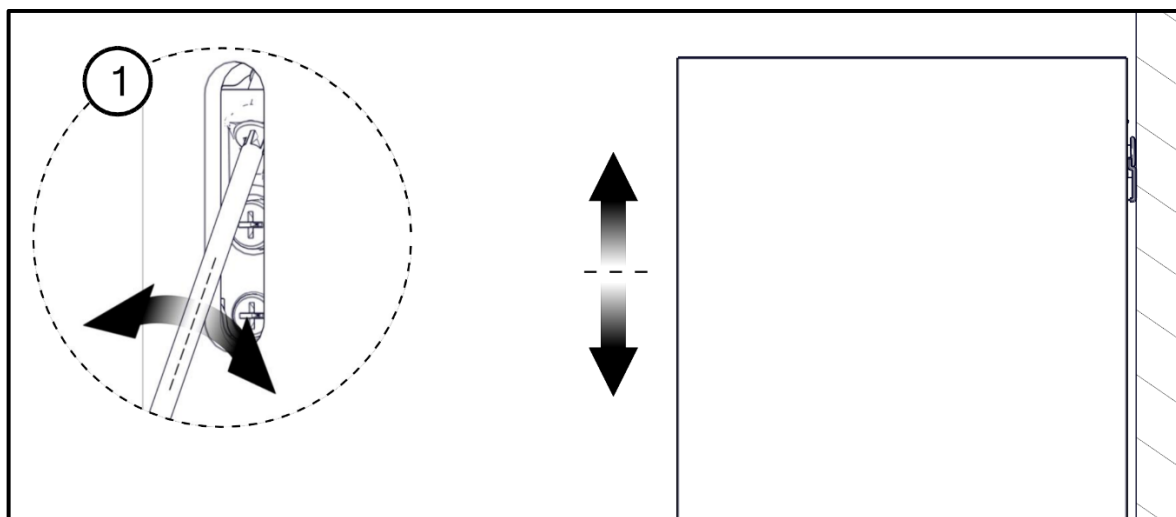



Vertiko - Vertical

5

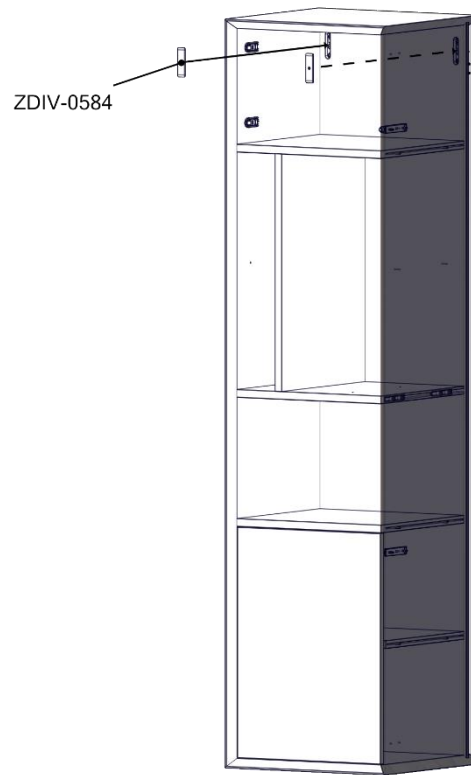

6

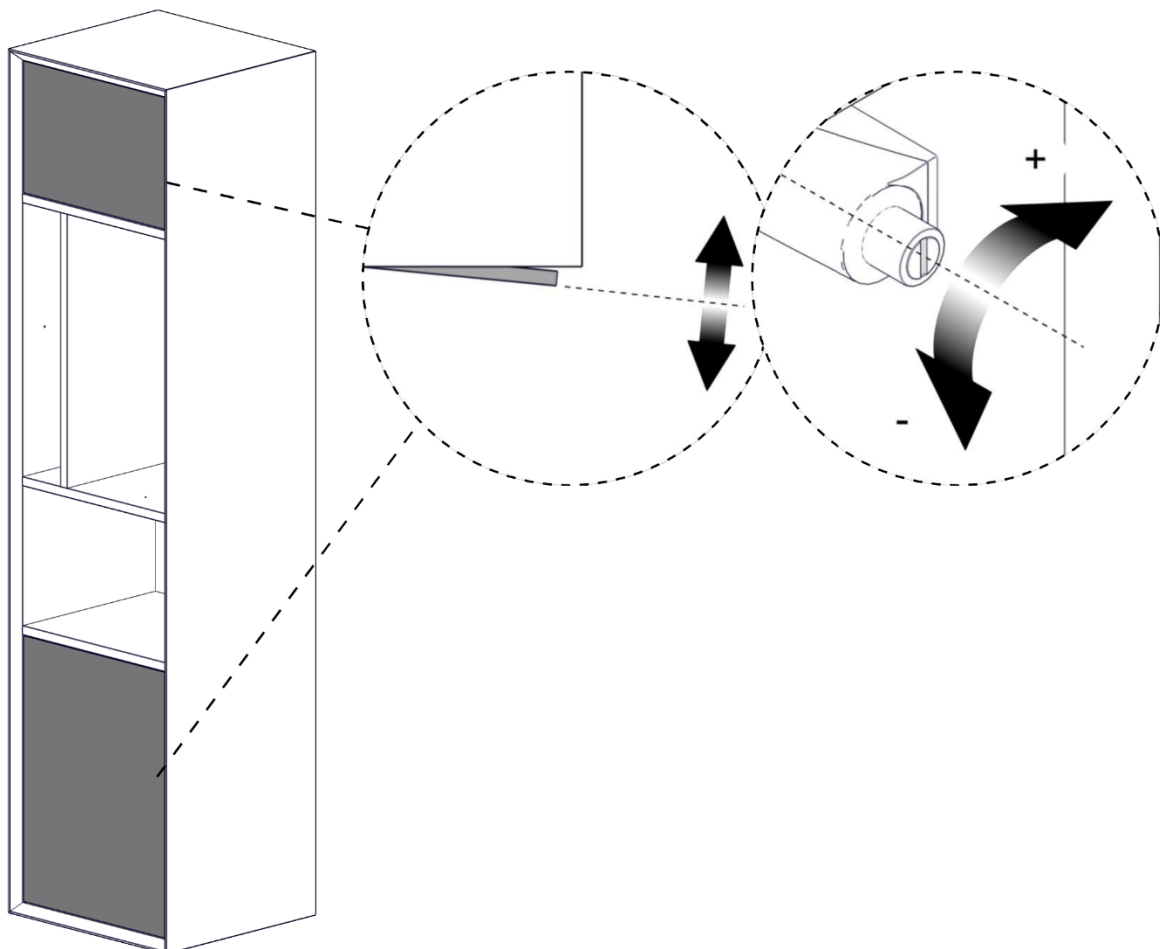



Deutsch

Für detaillierte Hinweise zu den Einstellmöglichkeiten der Topfbänder, scannen Sie den QR-Code. Weitere Informationen auf der nächsten Seite.



English

For detailed information on the setting options of the pot tapes, scan the QR Code. More information on the next page.

CLIP top BLUMOTION

Deaktivierung / Deactivation / Désactivation / Disattivazione / Desactivación

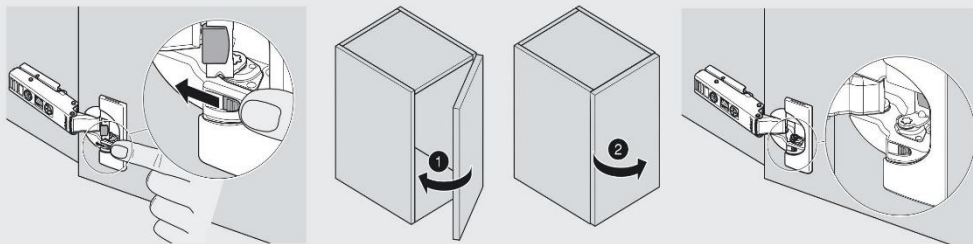

Deaktivierung einer BLUMOTION bei kleinen / leichten Fronten.
 Deactivation of BLUMOTION for small / light fronts
 Désactivation d'un BLUMOTION pour faces petites / légères
 Disattivazione di un BLUMOTION con ante piccole e/o leggere
 Desactivación de BLUMOTION con frentes pequeñas / levas

Aktivierung / Activation / Activation / Attivazione / Activación

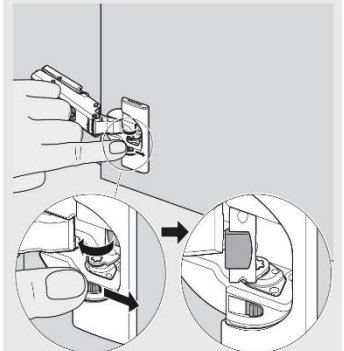

Verstellung / Adjustment / Réglage / Regolazione / Ajuste

