

B1, B2, B3

20160403



HDPE

LDPE

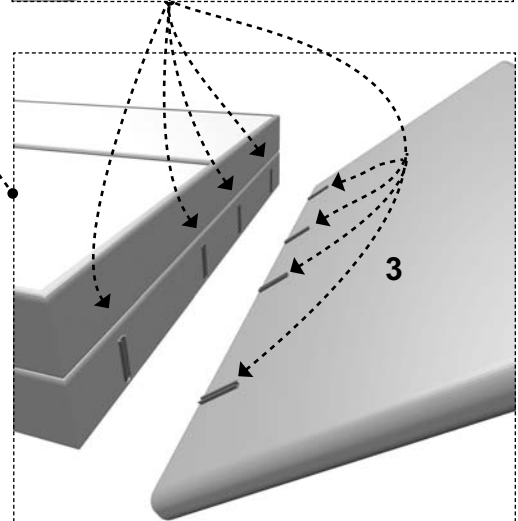
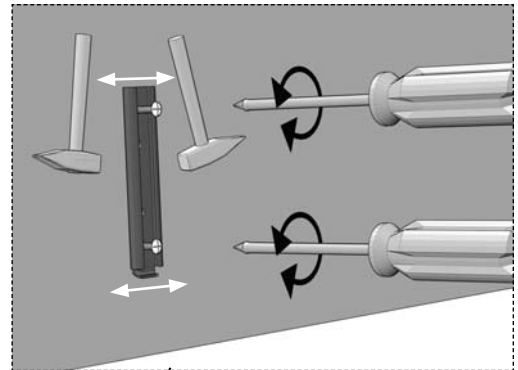
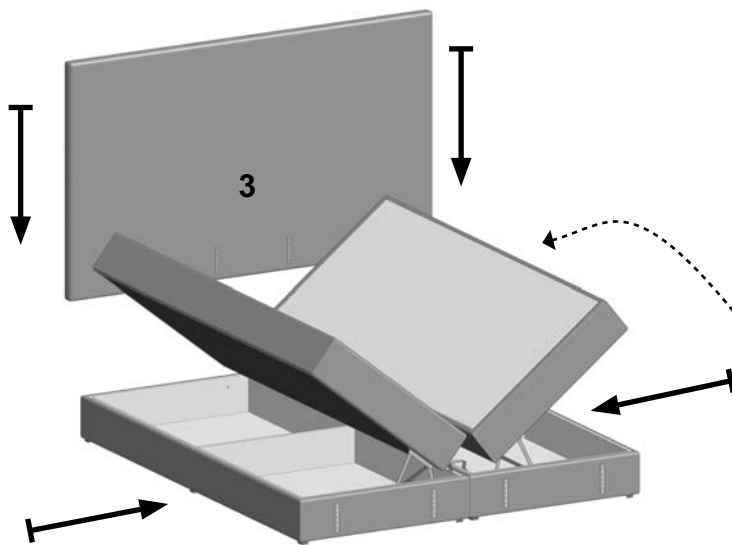
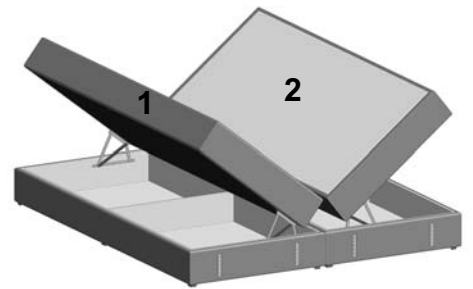
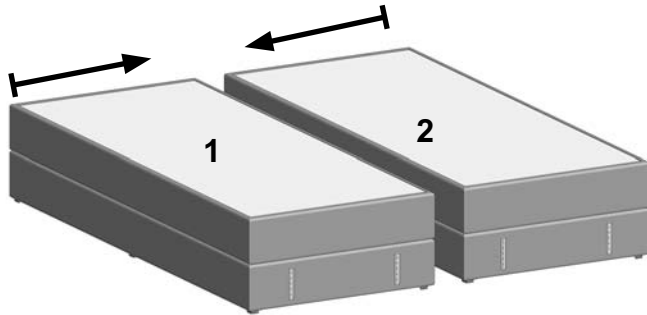
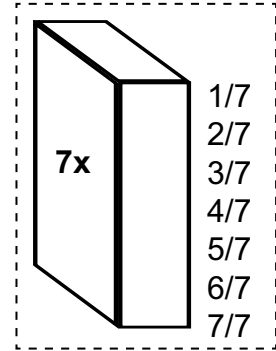

B1, B2, B3

20160403

