

Art. Nr. 49484309, 54523824,
85045113, 35177247

LKZ 40605

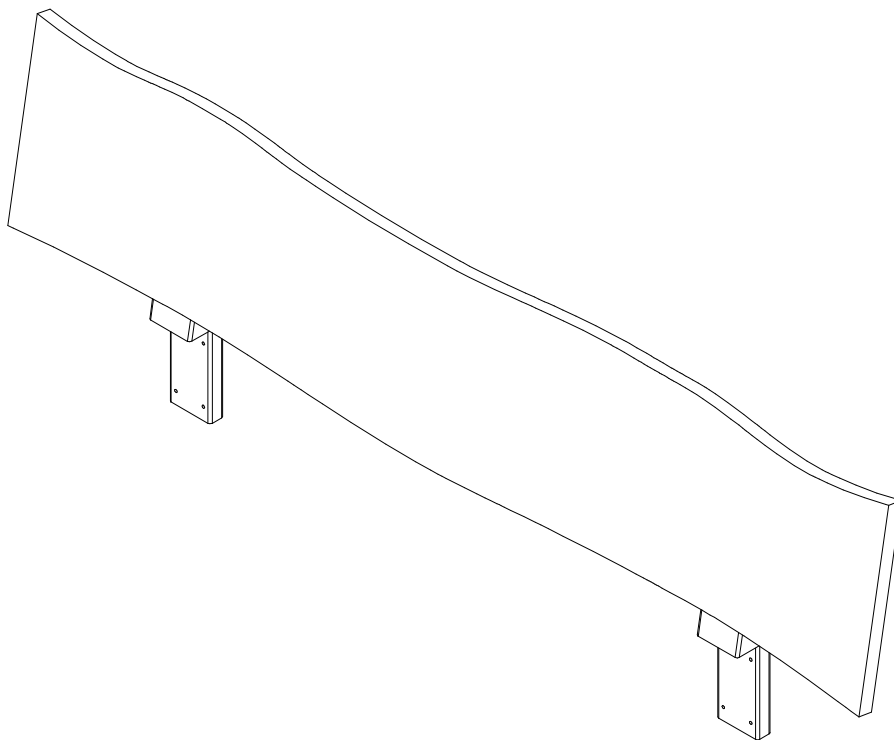

- | | | | |
|-----------|------------------------------------|-----------|--------------------------------|
| D | Montageanleitung | GB | Assembly instructions |
| FR | Notice de montage | IT | Istruzioni di montaggio |
| NL | Handleiding voor de montage | PL | Instrukcja montażu |
| CZ | Montážní návod | SK | Návod na montáž |
| HU | Szerelési útmutató | RO | Instrukțiuni de montaj |
| TR | Montaj talimatı | RU | Инструкция по монтажу |

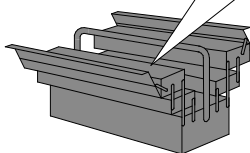
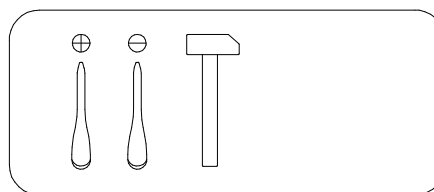
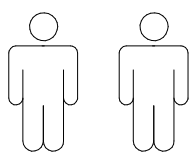

0
10
20
30
40
50
60
70
80
90
100
110
120
130
140
150
160
170
180
190
200

Service · Dienstverlening · Serwis · Servis · Сервисная служба

Name · Naam · Nazwa · Isim · Название

Nr. · No. · Номер

Typ · Type · Tip · Тип

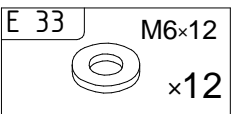
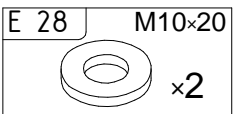
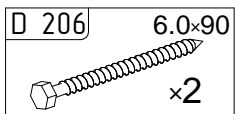
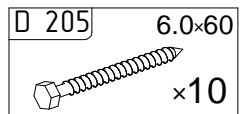
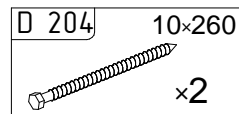
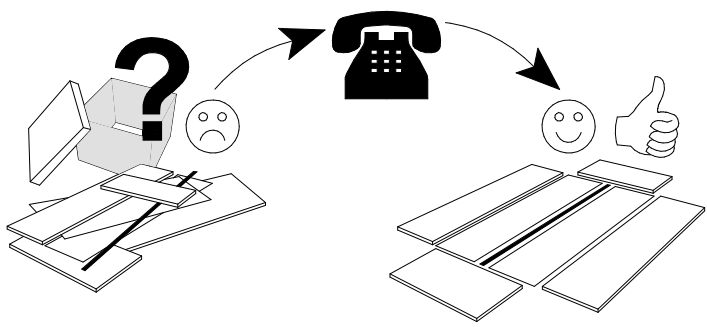
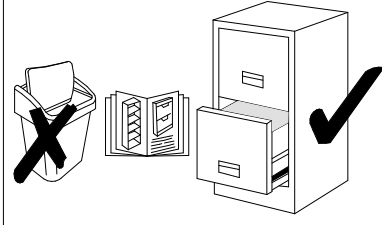

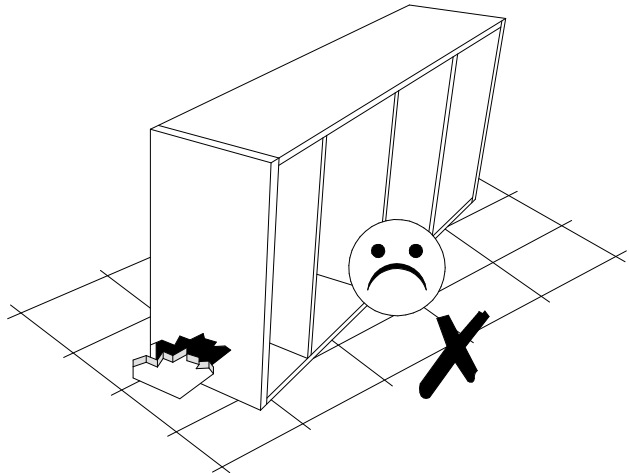
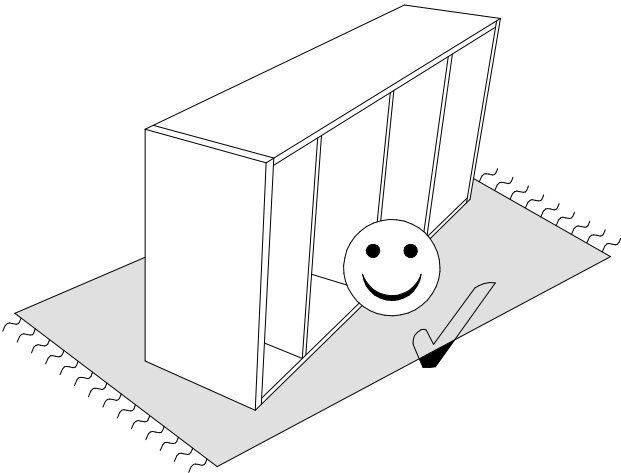

| N | Size/MaB (mm) | Qty | ✓ |
|---|----------------|-----|---|
| 1 | 1990(1590)x400 | 1 | |
| 2 | 530x96 | 2 | |

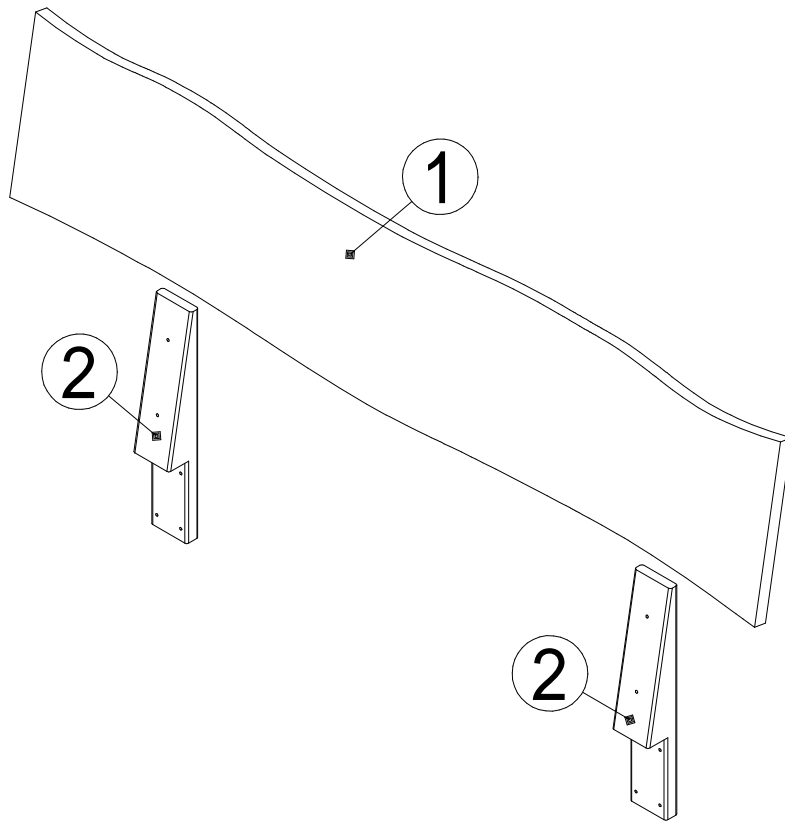



1

| | |
|---|-------|
| E 33 | M6×12 |
|  | ×4 |

| | |
|---|--------|
| D 205 | 6.0×60 |
|  | ×2 |

| | |
|---|--------|
| D 206 | 6.0×90 |
|  | ×2 |

