

- (D) Montageanleitung
- (GB) Assembly instructions
- (NL) Handleiding voor de montage

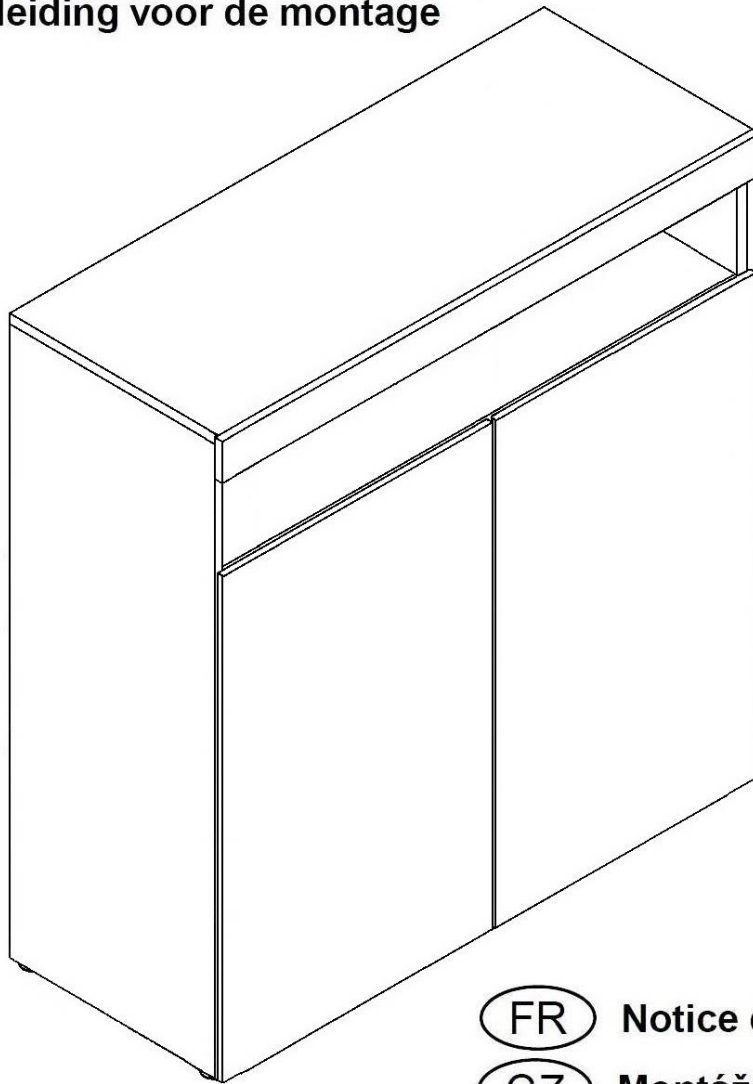

- (FR) Notice de montage
- (CZ) Montážní návod
- (TR) Montaj talimatı
- (IT) Istruzioni di montaggio
- (SK) Návod na montáž
- (RU) Инструкция по монтажу
- (HU) Szerelési útmutató
- (PL) Instrukcja montażu
- (RO) Instrucțiuni de montaj

**Service • Assistenza • Dienstverlening • Serwis
Servis • Szerviz • Сервисная служба**

Name • Nom • Nome • Naam • Nazwa • Jméno • Názov • Név • Denimire • İsim • Название	
Nr. • No. • N° • Номер • Č • Sz	
Тур • Туре • Тір • Тіpus • Тіpo • Тип	

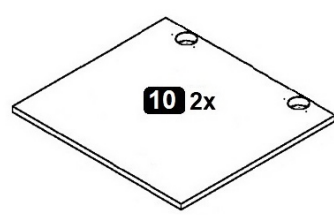
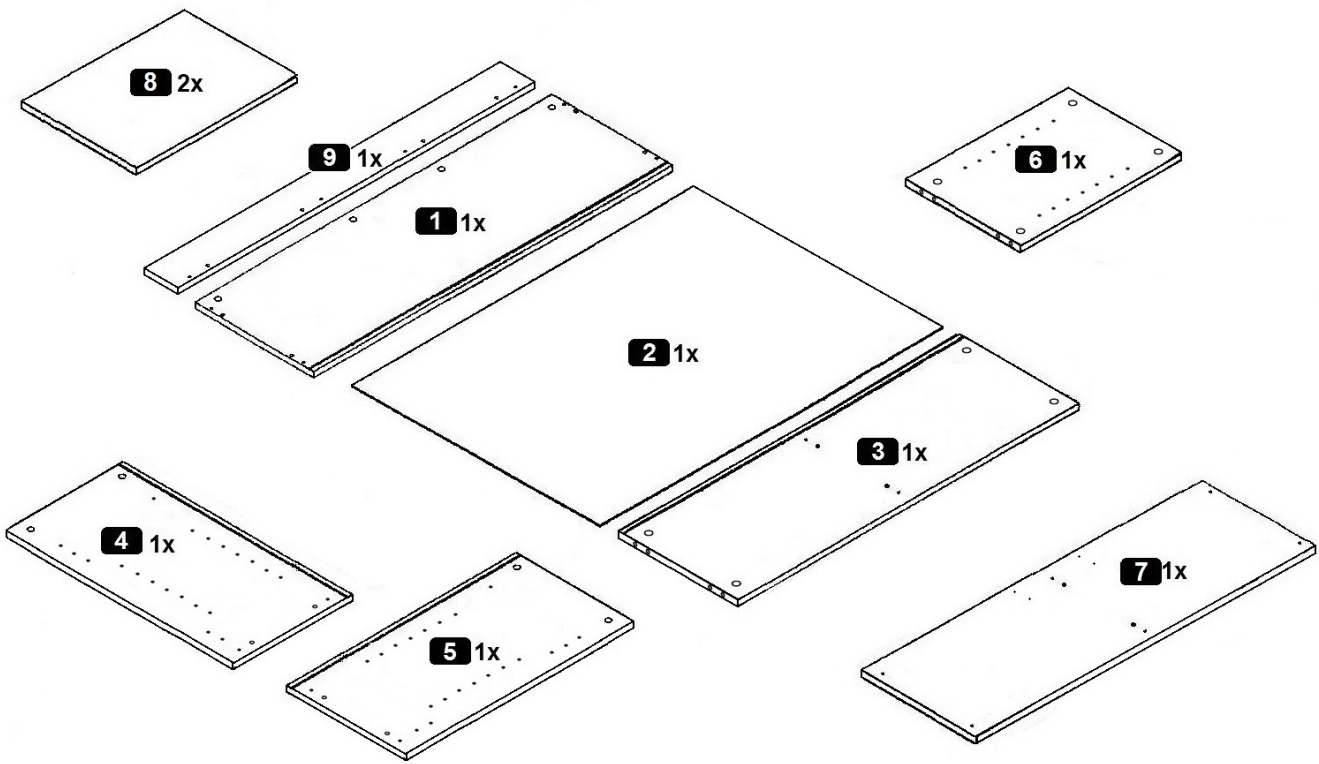
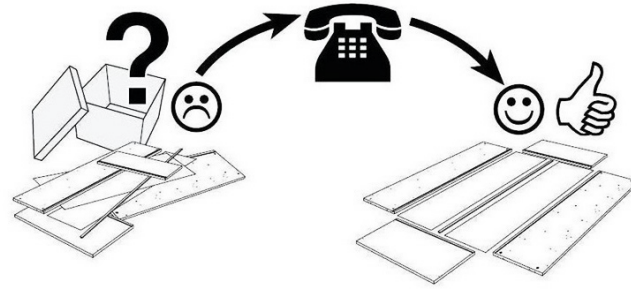
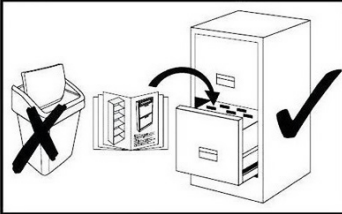

1	1x	ca. 1063 x 330 mm
2	1x	ca. 1044 x 894 mm
3	1x	ca. 1032 x 326 mm
4	1x	ca. 897 x 330 mm
5	1x	ca. 897 x 330 mm





6	1x	ca. 681 x 311 mm
7	1x	ca. 1032 x 311 mm
8	2x	ca. 507 x 300 mm
9	1x	ca. 1063 x 60 mm
10	2x	ca. 528 x 709 mm

A 8,0 x 30 mm 16x	B 16x	C 16x	D 3,9x9,5mm 2x	E h=2 4x	F Ø35 Kr.0 3,5x13mm 4x	G 8x
H 4,0 x 20 mm 5x	I 5x	J 2,7 x 20 mm 4x	K 4x			

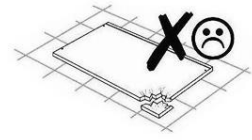
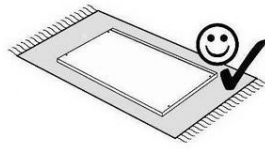
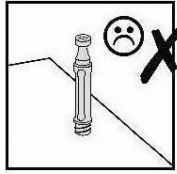
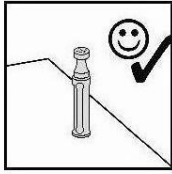



1

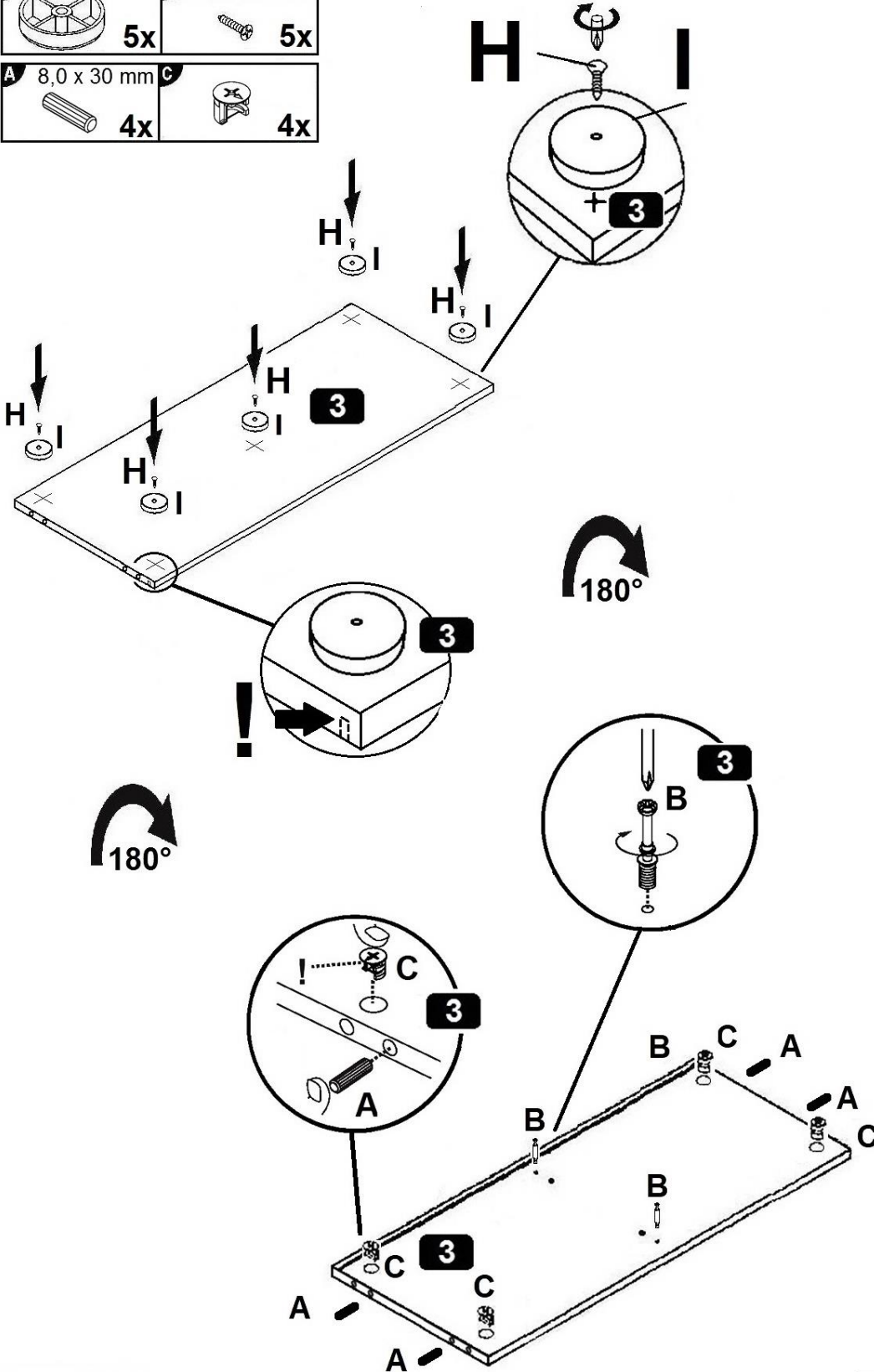

- | | |
|--|--|
| B

2x | H

4,0 x 20 mm
5x |
| A

8,0 x 30 mm
4x | C

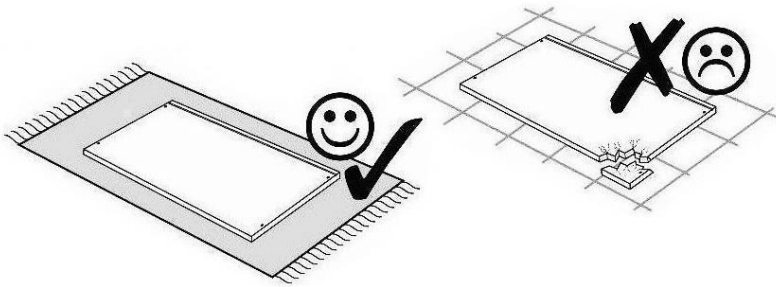
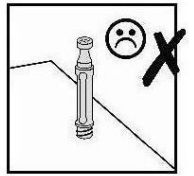
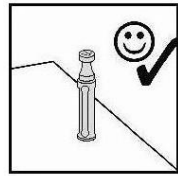
4x |



2

- A** 8,0 x 30 mm **4x**
- B**  **8x**
- C**  **4x**



1.!

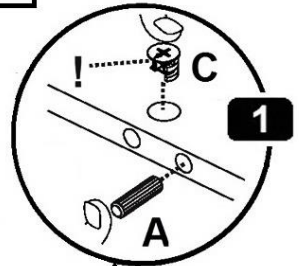



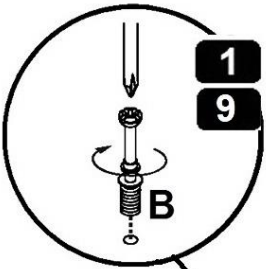

2.!

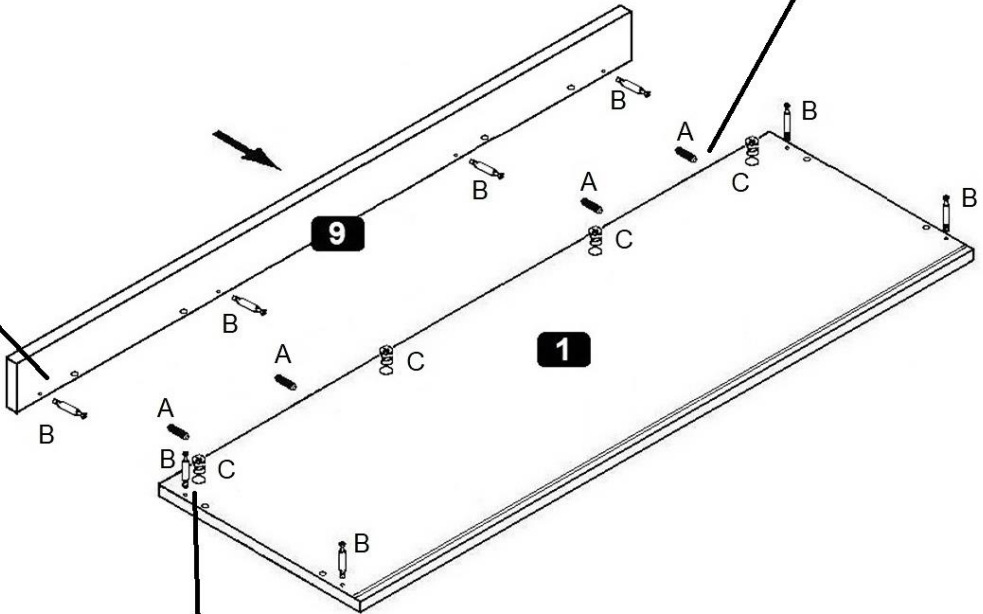
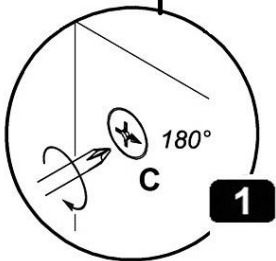

3.!



3

A 8,0 x 30 mm  8x	B  6x	C  8x	D 3,9x9,5mm  2x	E h=2  4x
---	---	---	---	---

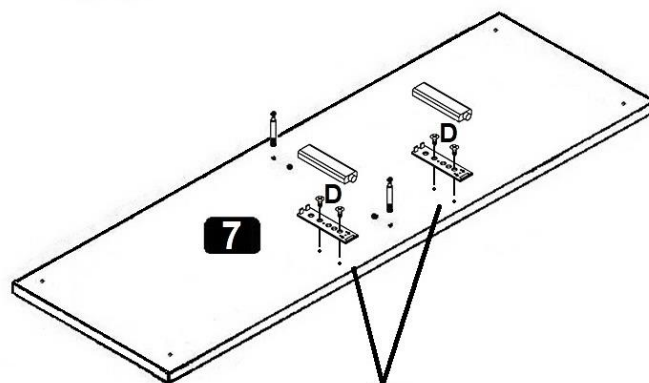
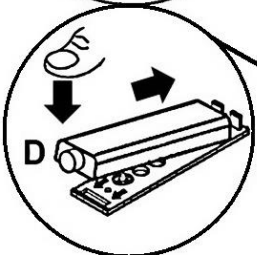
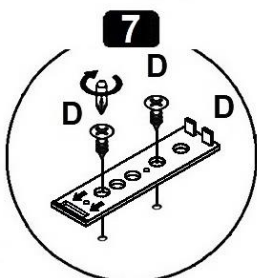
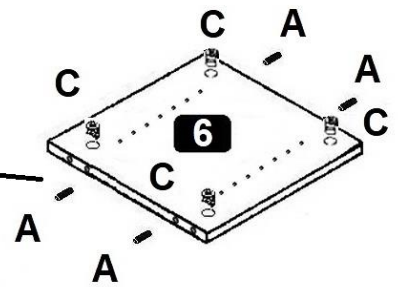
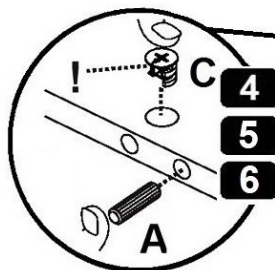
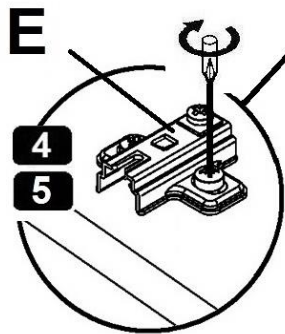
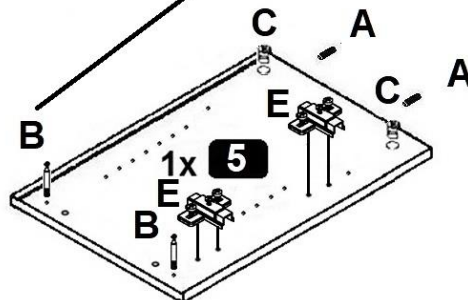
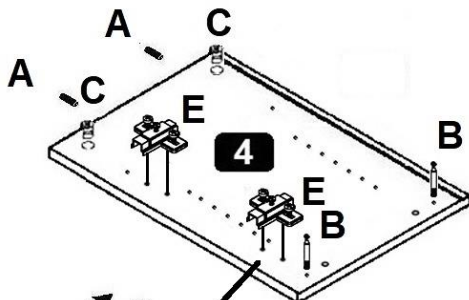
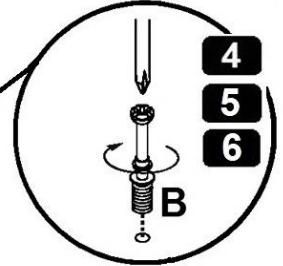
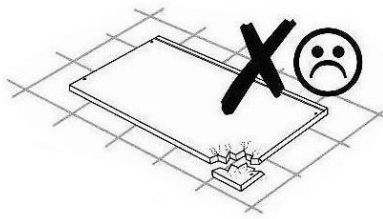
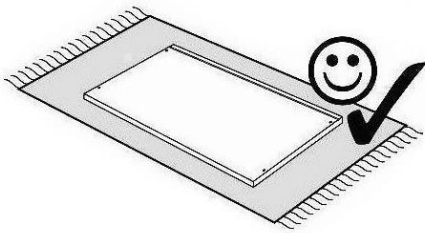
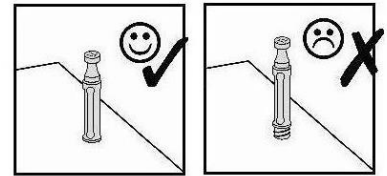

4

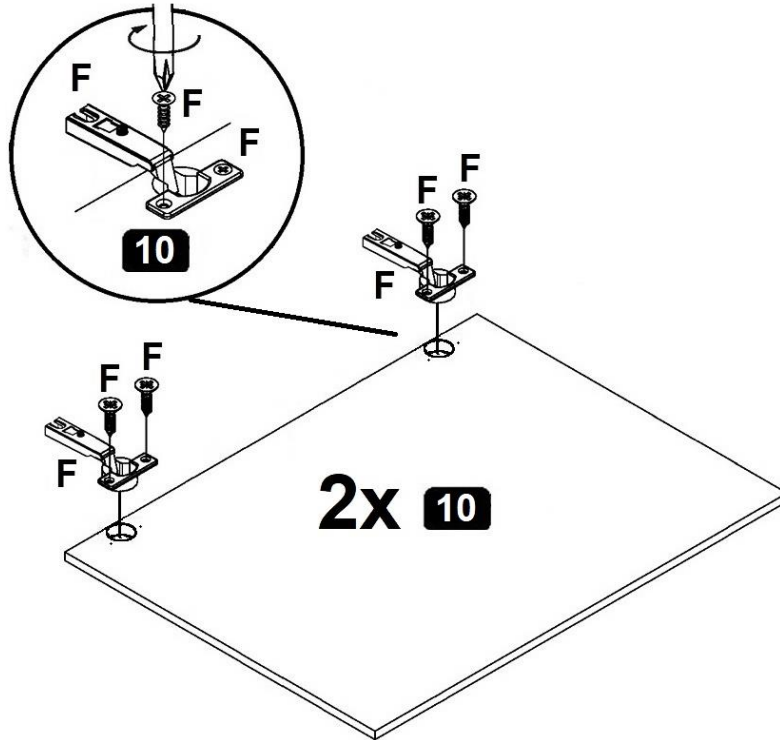
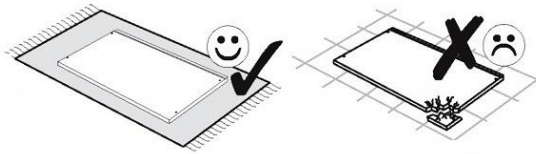

5

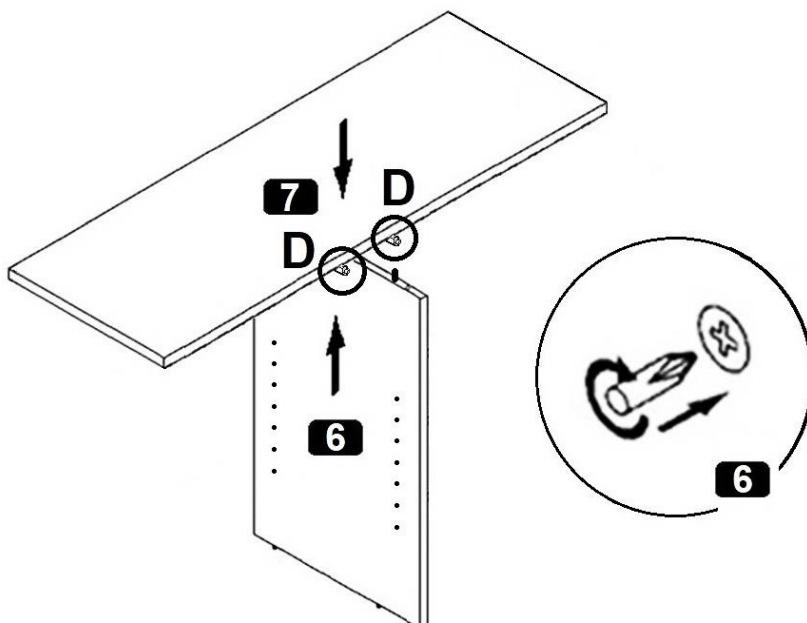

6

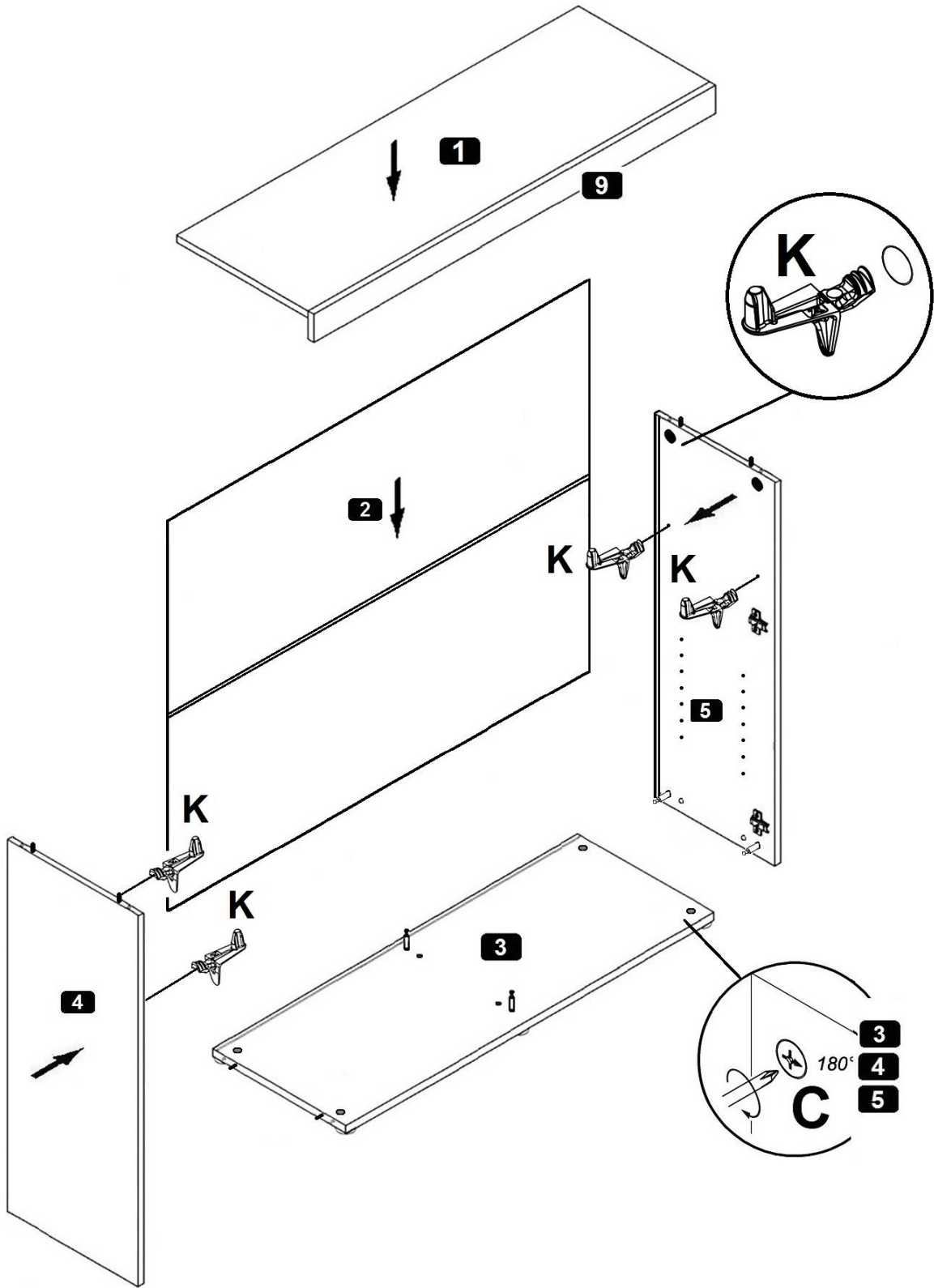
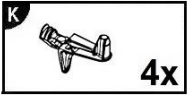

7

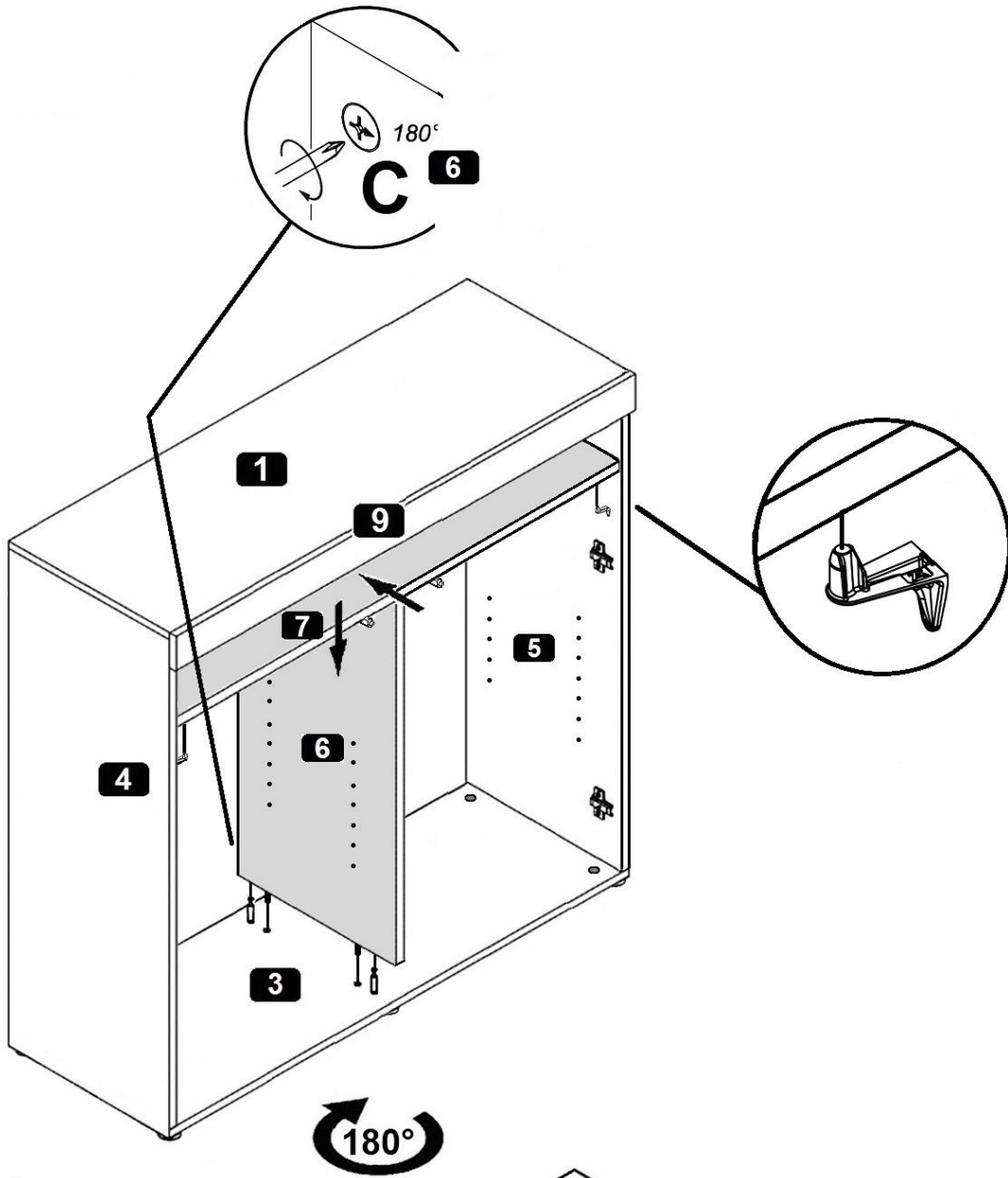

8

J 2,7 x 20 mm
4x

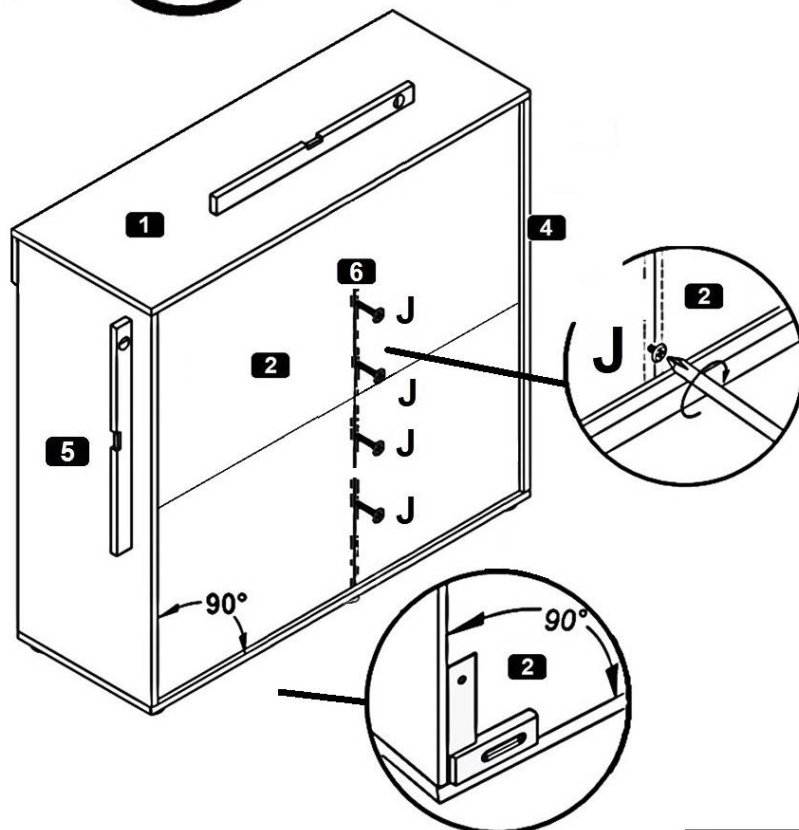



MA1

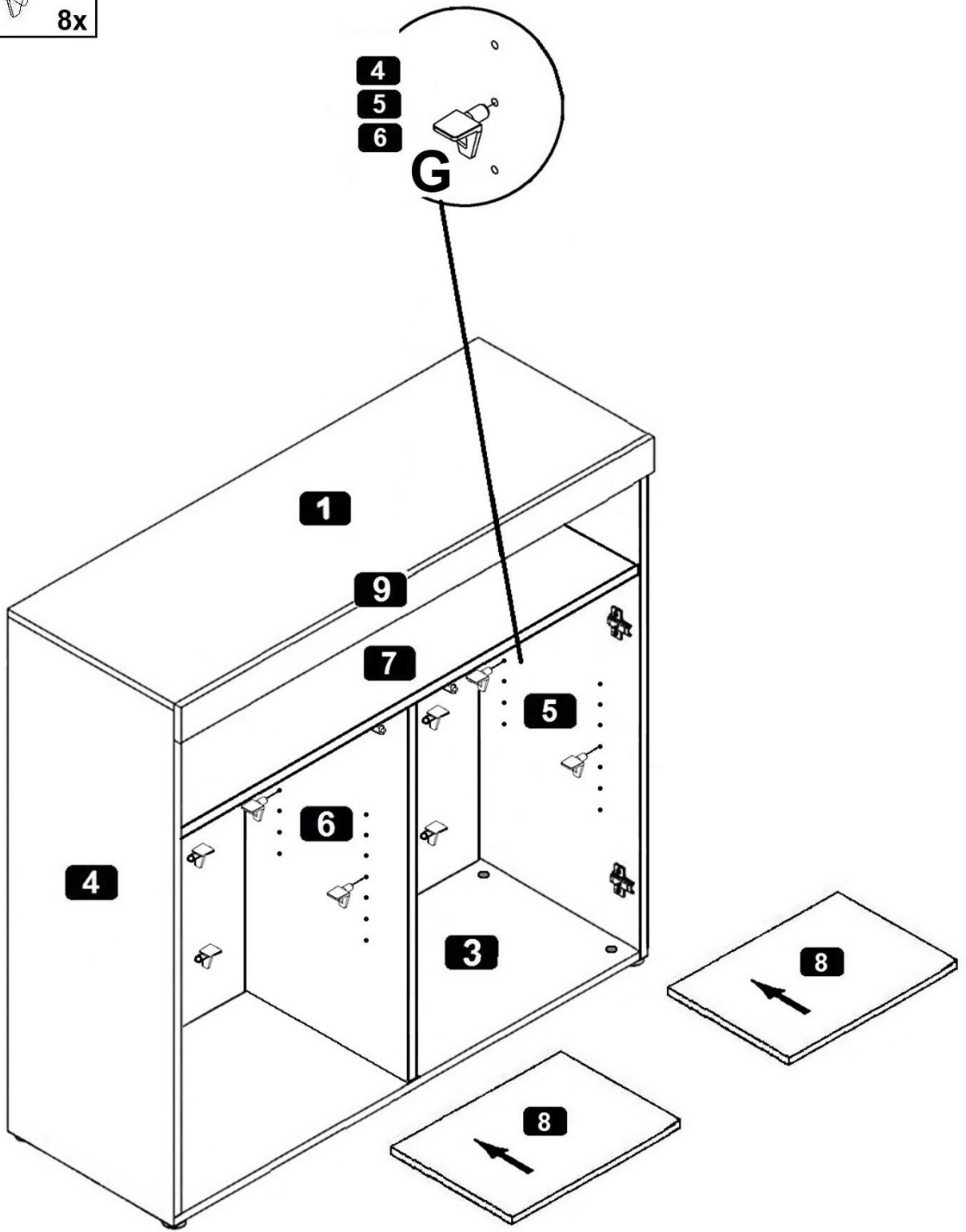
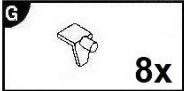

9

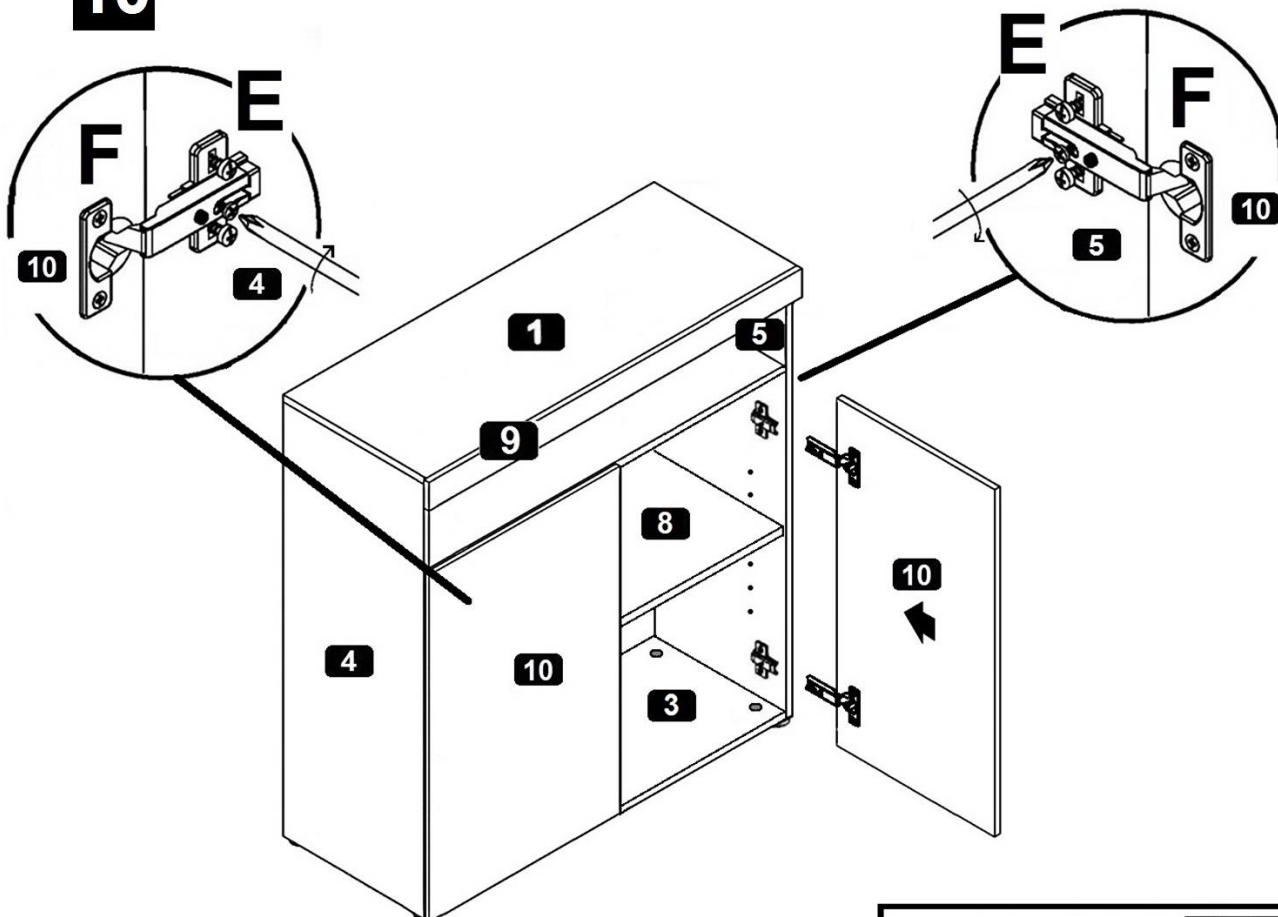

10

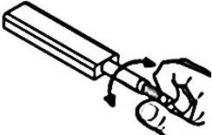

➔ 11 / 12 





(D) Push-To-Open einstellen
 (GB) Adjusting the Push-To-Open
 (FR) Régler les Push-To-Open
 (IT) Sistemare Push-To-Open
 (NL) Push-To-Open instellen
 (PL) Nastawić Push-To-Open
 (CZ) Vyrovnajte Push-To-Open
 (RO) Nastavenie Push-To-Open
 (HU) Állítsa be az Push-To-Open
 (SK) Reglare Push-To-Open
 (TR) Push-To-Open ayarlanması
 (RU) Регулировка Push-To-Open

➔ 12 / 12 



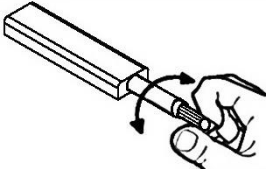

(D) Türen einstellen (Scharniere justieren)
 (GB) Adjusting the doors (adjusting the hinges)
 (FR) Régler les portes (ajuster les charnières)
 (IT) Sistemare le porte (regolare le cerniere)
 (NL) Deuren instellen (scharnieren afstellen)
 (PL) Nastawić drzwi (wyregulować zawiasy)
 (CZ) Vyrovnajte dvířka (seřid'te závěsy)
 (RO) Nastavenie dverí (nastavenie závesov)
 (HU) Állítsa be az ajtókat (állítsa be a zsanérokat)
 (SK) Reglare uši (ajustare balamale)
 (TR) Kapıların ayarlanması (mentşelerin seviye ayarı)
 (RU) Регулировка дверей (регулировка шарнира)

  	
(D) Push-To-Open einstellen	(CZ) Vyrovnajte Push-To-Open
(GB) Adjusting the Push-To-Open	(RO) Nastavenie Push-To-Open
(FR) Régler les Push-To-Open	(HU) Állítsa be az Push-To-Open
(IT) Sistemare Push-To-Open	(SK) Reglare Push-To-Open
(NL) Push-To-Open instellen	(TR) Push-To-Open ayarlanması
(PL) Nastawić Push-To-Open	(RU) Регулировка Push-To-Open

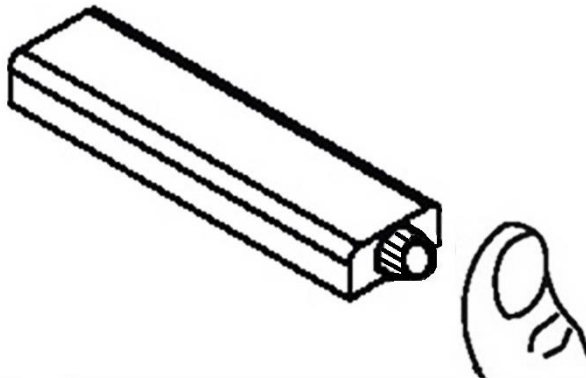
1.

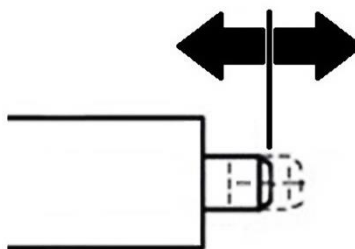
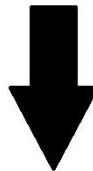
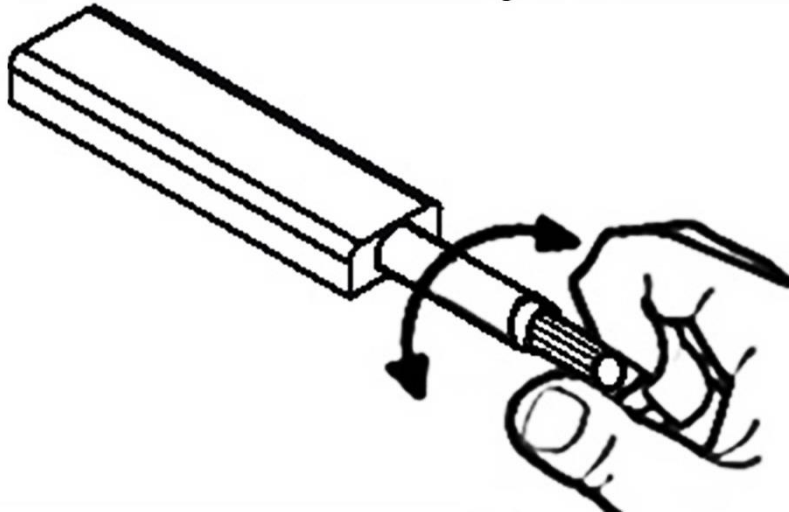

2.



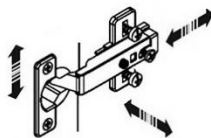

(D) Türen einstellen
(Scharniere justieren)

(GB) Adjusting the doors
(adjusting the hinges)

(FR) Régler les portes
(ajuster les charnières)

(IT) Sistemare le porte
(regolare le cerniere)

(NL) Deuren instellen
(scharnieren afstellen)

(PL) Nastawić drzwi
(wyregulować zawiasy)

(CZ) Vyrovnajte dvířka
(seřid'te závěsy)

(RO) Nastavenie dverí
(nastavenie závesov)

(HU) Állítsa be az ajtókat
(állítsa be a zsanérokot)

(SK) Reglare uši
(ajustare balamale)

(TR) Kapıların ayarlanması
(menteşelerin seviye ayarı)

(RU) Регулировка дверей
(регулировка шарнира)

