

**(D)** *Montageanleitung*

**(NL)** *Handleiding voor de montage*

**(TR)** *Montaj talimatı*

**(FR)** *Notice de montage*

**(CZ)** *Montážní návod*

**(HU)** *Szerelési útmutató*

**(GB)** *Assembly instructions*

**(PL)** *Instrukcja montażu*

**(RU)** *Инструкция по монтажу*

**(IT)** *Istruzioni di montaggio*

**(SK)** *Návod na montáž*



**(RO)** *Instrucțiuni de montaj*

Name • Nom • Nome • Naam • Nazwa • Jméno •  
Názov • Név • Denumire • Isim • Название

Nr. • No. • N° • Номер • Č • Sz

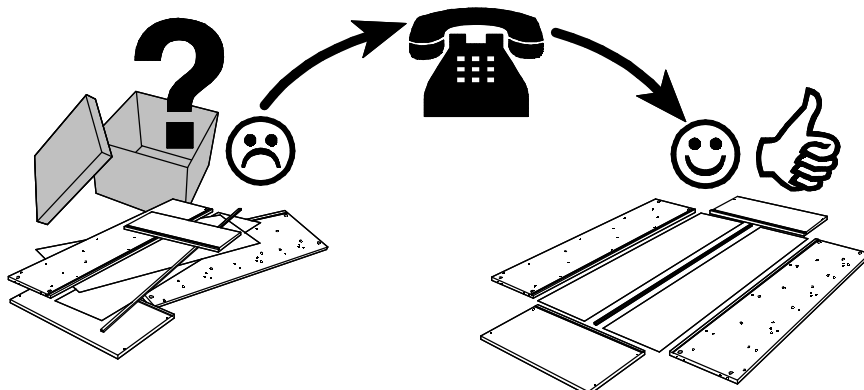
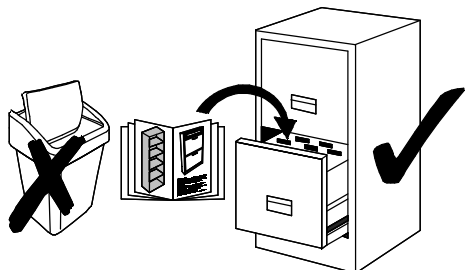
Typ • Type • Tip • Típus • Tipo • Тип

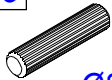
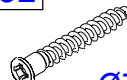
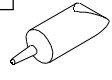
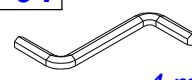

<b>A10</b>  Ø8 x 35	3 x <b>B52</b>  Ø7 x 50	4 x <b>F01</b> 	1 x <b>F04</b>  4 mm	1 x <b>H16</b>  Ø4,0 x 60	2 x <b>K22</b>  Ø20 x 9	2 x
--	--	---	--	--	--	-----

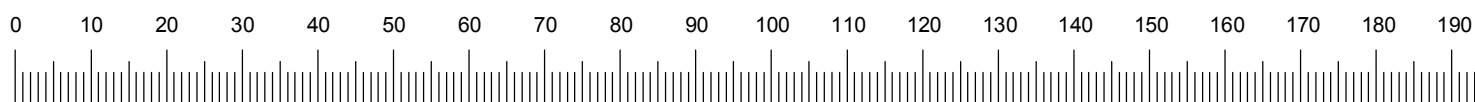
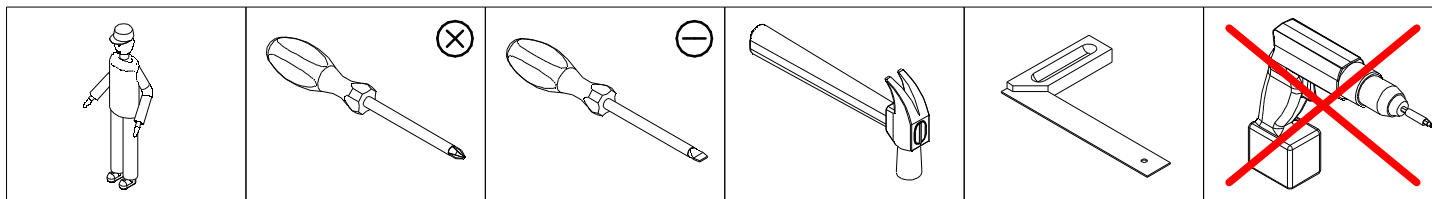
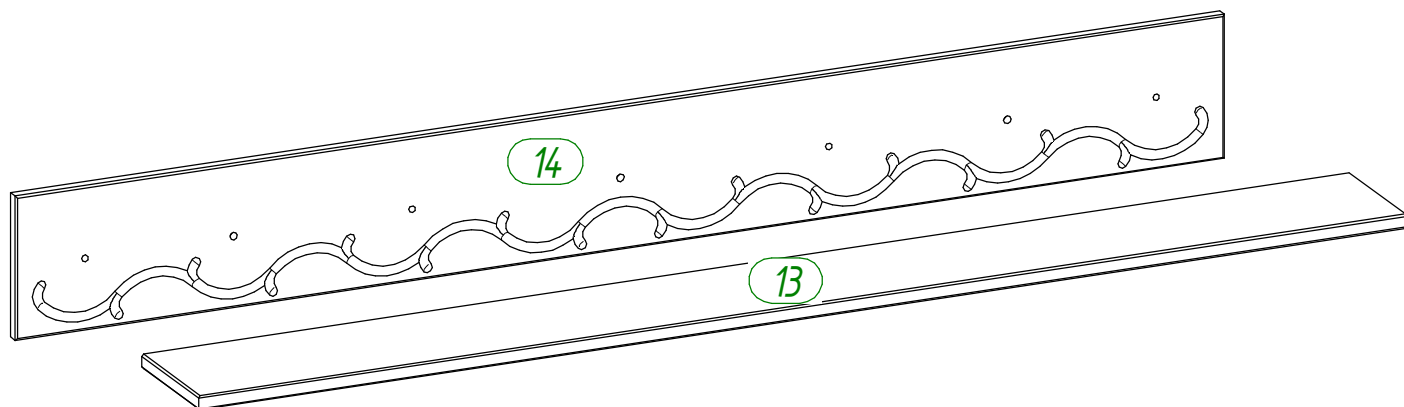

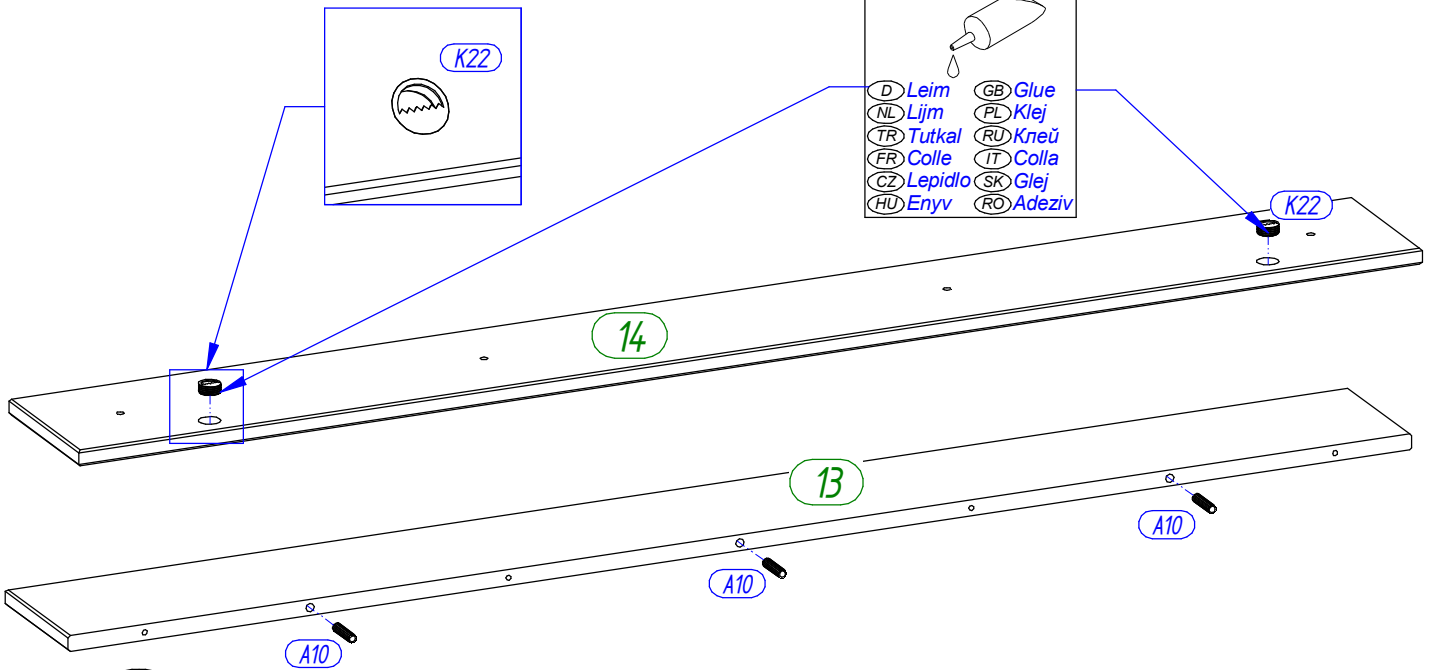
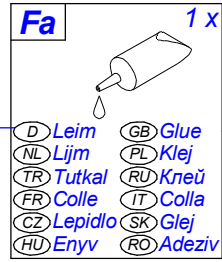
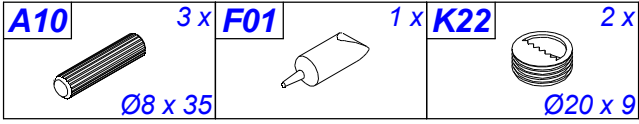
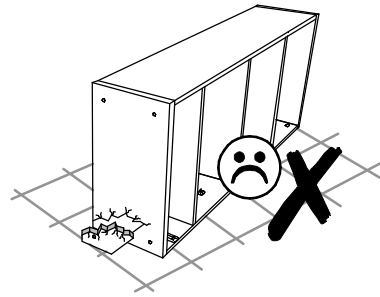
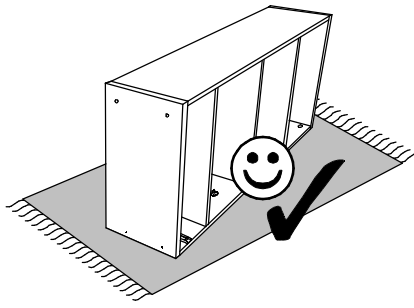

1

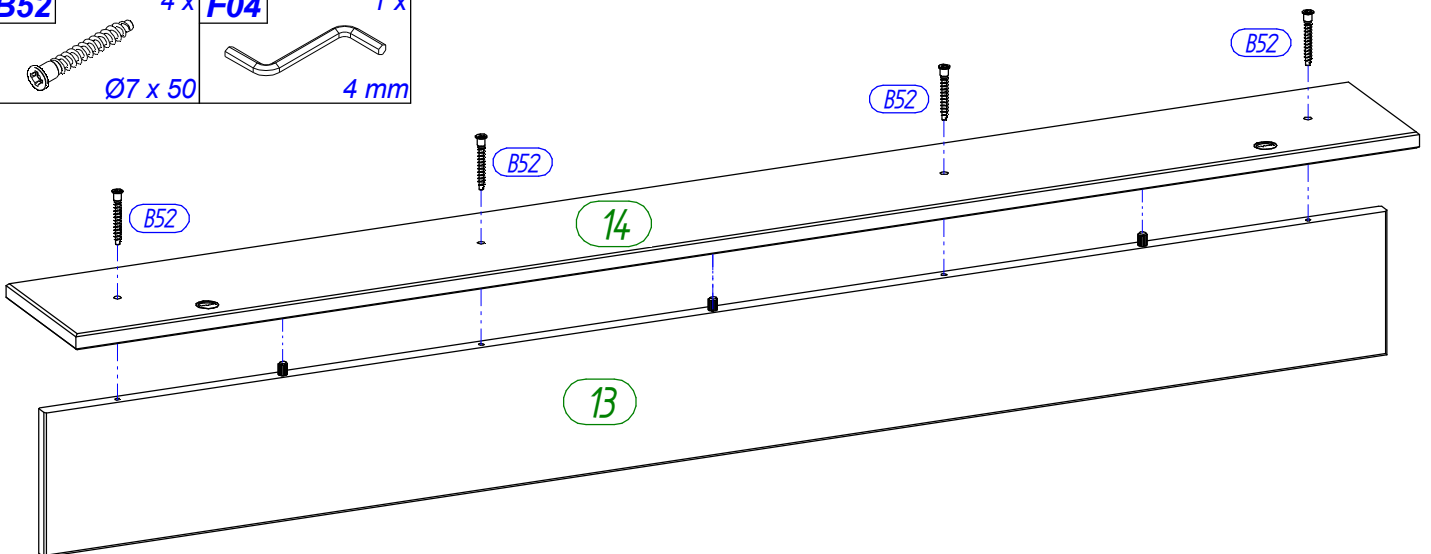
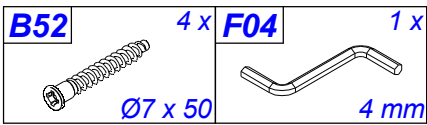

2

<b>(D)</b>	Bei einigen Wandtypen kann ein Spezialdübel erforderlich sein!
<b>(GB)</b>	For certain wall types, a special dowel may be necessary!
<b>(NL)</b>	Bij enkele muurtypes is een speciale plug misschien vereist!
<b>(PL)</b>	Do niektórych rodzajów ścian konieczne mogą być specjalne wkręty!
<b>(TR)</b>	Bazı duvar tiplerinde bunun için özel bir dübel gerekli olabilir!
<b>(RU)</b>	Для некоторых типов стен может потребоваться специальный дюбель!
<b>(FR)</b>	Pour certains types de murs il faut des chevilles spéciales !
<b>(IT)</b>	Per alcune strutture di parete può essere necessario un tassello speciale!
<b>(CZ)</b>	U některých typů stěn může být zapotřebí speciální hmoždinka!
<b>(SK)</b>	Pre niektoré druhy stien môže byť potrebná špeciálna hmoždinka!
<b>(HU)</b>	Egyes faltípusoknál speciális tiplít kell használni!
<b>(RO)</b>	Pentru unele tipuri de pereți este posibil să fie necesar un diblu special!

