

Stauraumbett

# STEFAN 90

DEUTSCH  
ENGLISH  
NEDERLANDSE  
FRANÇAIS  
SLOVENSKÝ  
ČESKÝ  
MAGYAR  
HRVATSKI

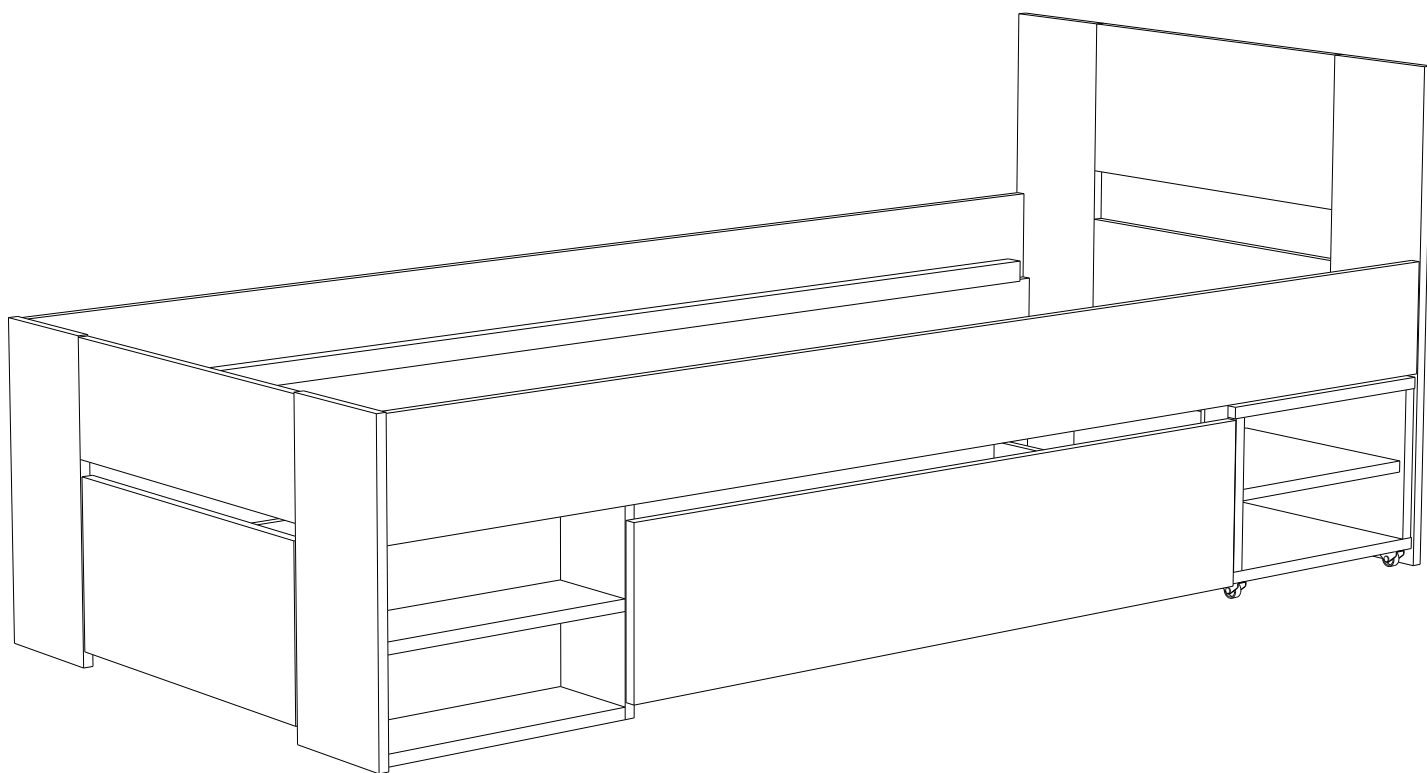

Für Ersatzteilbestellungen und bei Reklamationen bitte nachfolgende Hinweise beachten.



Sehr geehrte(r) Kundin/Kunde.

Sollte ein Teil Ihres bestellten Produktes beschädigt sein oder fehlen, werden wir Ihnen entsprechenden Ersatz liefern. Bitte senden Sie das Produkt nicht zurück.

Bitte füllen Sie die Angaben zum Ersatzteil bzw. Ihrer Reklamation in den unten angegebenen Feldern aus und senden Sie dieses Formblatt ausgefüllt zurück.

Zur Rücksendung können Sie folgende Möglichkeiten wählen:

- per Fax an: +49 -511 -271900
- per e-mail an: reklas@relita.com
- per Post an unsere Rücksendeadresse: Relita Dr.Woite GmbH, Bayernstr . 13, 30855 Langenhagen.

Folgendes bitte ausfüllen:

Name: \_\_\_\_\_

Adresse: \_\_\_\_\_

Telefonnummer: \_\_\_\_\_

e-mail (falls vorhanden): \_\_\_\_\_

Kundennummer (bei Reklamationen immer ausfüllen): \_\_\_\_\_

Artikelnummer: \_\_\_\_\_

Modellbezeichnung: \_\_\_\_\_

Farbe/Beschaffenheit (entsprechendes bitte umkreisen oder unterstreichen):

**natur**                      **weiß**                      **geölt**                      **lackiert**

Benötigte Teile

bitte ergänzen Sie die Bezeichnung die Teilenummer entsprechend der Ihnen vorliegenden Aufbauanleitung

<b>Produkt/Name</b>	<b>Teilenr./Schraubennr.</b>	<b>Bezeichnung/Maße</b>	<b>Anzahl</b>
Stauraumbett Stefan 90			



Relita Dr. Woite GmbH

BR57041156 / BR57041155 / BR57041157 /  
BR57041129 / BR57041150 - B90

Stand/version 29.05.2024

**Gebrauchsanleitung: Stauraumbett STEFAN 90**

**Instruction manual: Storage Bed STEFAN 90**

Das Bett sollte von 2 Personen aufgebaut werden.

(DE)

**Wichtig!**

Bitte lesen Sie die Gebrauchsanleitung mit den Warn- und Sicherheitshinweisen vor dem Aufbau des Bettes sorgfältig durch und bewahren Sie diese danach auf. Die Gebrauchsanleitung beinhaltet darüberhinaus eine Montageanleitung mit einer Stückliste sowie die notwendigen Werkzeuge für einen sicheren Zusammenbau Ihres Bettes. Wichtig ist das alle Teile und das die benötigten Werkzeuge vollständig vorhanden sind.

**Warn- und Sicherheitshinweise:**

Die Sicherheitshinweise des Herstellers sind stets zu befolgen. Zum einzelnen sind diese:

1. Achten Sie beim Zusammenbau des Bettes darauf, dass die Verbindungselemente fest angezogen werden. Die Verbindungselemente müssen auch während des Gebrauchs auf Ihren festen Sitz kontrolliert werden.
2. Das Bett darf nicht benutzt werden, wenn ein konstruktives Bauteil beschädigt ist oder fehlt.
3. Folgende Gegenstände dürfen nicht am Bett befestigt oder angehängt werden: Stricke, Schnüre, Kordeln, Gurte, Bänder, etc.. Es besteht Strangulationsgefahr!
4. Eine ausreichende Raumbelüftung ist notwendig, um die Luftfeuchte niedrig zu halten und Schimmelbildung in und um das Bett zu verhindern.

**Pflegehinweis:**

Das Bett darf nur mit einem feuchten Lappen gereinigt werden.

- ID. Kennung; Stauraumbett STEFAN 90
- Sperrholz

The bed should be put together by 2 people.

(EN)

**Important!**

Please carefully read the instruction manual with the warning and safety instructions before assembling the bed and keep them for future use. The owner's manual also includes assembly instructions with a parts list and the tools required for safe assembly of your bed. It is important to ensure all components and the tools required to be available and complete.

**Warning and safety instructions:**

Please ensure to generally observe the manufacturer's assembly instructions. In detail, these are:

1. When assembling the bed, make sure that the connecting elements are tightened correctly. The connecting elements must also be monitored for tightness during use.
2. The bed may not be used if any component is missing or broken.
3. The following items may not be attached to or hung on the bed ropes, string, cords, straps, belts, etc... Danger of strangulation!!
4. Please note that the room is to be aerated thoroughly to keep the air humidity low and prevent the formation of mould inside and around the bed.

**Care instructions:**

The bed should be cleaned only with a damp cloth.

- ID. identifier; Storage Bed STEFAN 90
- Plywood



Relita Dr. Woite GmbH

BR57041156 / BR57041155 / BR57041157 /  
BR57041129 / BR57041150 - B90

versie/version 29.05.2024

**Gebruiksaanwijzing: Opbergbed STEFAN 90**

**Mode d'emploi du lit coffre STEFAN 90**

Het bed moet door twee personen opgebouwd worden

(NL)

**Belangrijk!**

Lees alstublieft zorgvuldig de gebruiksaanwijzing met de waarschuwings- en veiligheidsaanwijzingen voor de opbouw van het bed en bewaar deze daarna.

De gebruiksaanwijzing bevat bovendien een montagehandleiding met een onderdelenlijst alsook de noodzakelijke werktuigen voor een veilige assemblage van uw bed. Belangrijk is dat alle delen en het noodzakelijke gereedschap volledig beschikbaar zijn.

**Waarschuwings- en veiligheidsaanwijzingen:**

De montage-instructies van de producent moeten altijd nauwgezet opgevolgd worden. Deze zijn:

1. Let er bij de assemblage van het bed op, dat de verbindingselementen stevig aangezet worden. De verbindingselementen moeten ook gedurende het gebruik op hun stevigheid gecontroleerd worden.
2. Het bed mag niet gebruikt worden als een of ander bouwdeel ontbreekt of gebroken is.
3. Volgende voorwerpen mogen niet aan het bed bevestigd of opgehangen worden: strikken, snoeren, koorden, gordels, banden, enzovoort. Er is wurgingsgevaar!!
4. Voldoende kamerverluchting is noodzakelijk om de luchtvochtigheid laag te houden en schimmelvorming in en om het bed te voorkomen.

**Onderhoudstip:**

Het bed mag alleen met een vochtige doek gereinigd worden

- ID-code; Opbergbed STEFAN 90
- Multiplex

Le lit doit être monté de la part de deux personnes

(FR)

**Important !**

Avant de commencer à monter le lit, veuillez lire attentivement cette instruction d'utilisation qui contient des instructions d'avertissements et de sécurité. Gardez-la pour l'utiliser plus tard au cas de besoin.

**Instructions d'avertissements et de sécurité :**

Veuillez obligatoirement respecter les instructions données de la part de producteur. Dans les instructions il y a des détails donnés ci-dessous :

1. Au cours de de montage du lit, assurez-vous que les éléments d'attachement sont bien fixes. La fixation des éléments d'attachements doit être surveiller même au cours de son utilisation.
2. Le lit ne pourrait pas être utilisé au cas où il manque des pièces ou il y en a des pièces cassées.
3. Les objets suivants ne doivent pas être accrochés au lit: ex. Cordes, fils, câbles, lacets, ceintures etc. Danger d'étouffement !!
4. Veuillez retenir que l'espace doit être complètement aéré en fonction de maintenir le bas pourcentage de l'humidité et d'empêcher la moisissure à l'intérieur et autour du lit.

**Instructions de maintenance :**

La maintenance du lit doit être faite avec des chiffons humides

- ID indicateur ; Lit coffre STEFAN 90
- Contre-plaqué



Relita Dr. Woite GmbH

BR57041156 / BR57041155 / BR57041157 /  
BR57041129 / BR57041150 - B90

verzia / verze 29.05.2024

**Návod na použitie: STEFAN 90 Úložná posteľ**

**Návod k použití: STEFAN 90 Úložné lůžko**

Posteľ by mala byť skladaná od dvoch ľudí

(SK)

**Dôležité!**

Pozorne si prečítajte návod na použitie, ktorý obsahuje výstražné a bezpečnostné pokyny, než začnete robiť posteľ. Uložte ho pre budúce použitie.

**Pokyny pre varovanie a bezpečnosť:** Postupujte podľa pokynov výrobcu. Podrobne zahŕňajú:

1. Pri zostavovaní posteli, skontrolujte, či sú spojovacie prvky bezpečne pripevnené. Tiež, počas používania sa musí kontrolovať upevnenie upevňovacích prvkov.
2. Posteľ sa nesmie používať, ak jedna z častí chýba alebo je rozbitá.
3. Nasledujúce predmety by sa nemali pripevňovať ani zavesiť na posteli: laná, drôty, káble, remene, pásy atď. Hrozí nebezpečenstvo utopenia!!
4. Upozorňujeme, že miestnosť by mala byť úplne vetraná aby sa udržala nízka úroveň vlhkosti vzduchu, čo by zabránilo tvorbe plesní vo vnútri, a okolo posteľe.

**Pokyny na údržbu:**

Posteľ by mala byť udržiavaná iba navlhčenou tkaninou

- ID identifikátor; Úložná posteľ STEFAN 90
- Preglejka

Lůžko by se mělo skládat dva člověka.

(CZ)

**Důležité!**

Přečtěte si pozorně návod k použití který také zahrňuje výstražné a bezpečnostní pokyny, než začnete skládat lůžko. Uložte jej a pro budoucí použití.

**Upozornění a bezpečnostní pokyny:**

Prosíme, postupujte podle pokynů výrobce. Mezi ně patří zejména:

1. Při sestavování lůžka se ujistěte, že jsou spojovací prvky správně připevněny. Rovněž pevnost spojovacích prvků musí být pozorována při použití taky.
2. Lůžko nelze použít v případě, že některá z částí chybí nebo je rozbitá.
3. Na lůžko nesmí být umístěny nebo zavěšeny následující předměty: lana, dráty, kabely, kravaty, popruhy atd. Existuje nebezpečí utopení!!
4. Upozorňujeme, že místnost by měla být plně větrána aby se udržovala nízká úroveň vlhkosti ve vzduchu, což by zabránilo vzniku plísní uvnitř, a kolem posteľe.

**Pokyny pro údržbu:**

Lůžko by mělo být udržováno pouze vlhkým hadříkem

- ID identifikátor; Úložné lůžko STEFAN 90
- Překližka



Relita Dr. Woite GmbH

BR57041156 / BR57041155 / BR57041157 /  
BR57041129 / BR57041150 - B90

változat / verzija 29.05.2024

Használati utasítás: STEFAN 90 Tárolóágy

Upute za uporabu: Krevet za odlaganje STEFAN 90

Az ágy összeszerelési folyamatát célszerű kettő embernek elvégeznie.

(HU)

#### Fontos!

Kérjük, az ágy összeszerelése előtt szíveskedjen elolvasni a használati útmutatót, melyből tudomást szerezhet az ágy szakszerű összeszerelési folyamatáról és egyben figyelmeztetést a biztonságos használattal kapcsolatban. Őrizze meg a használati útmutatót, mert a jövőben még szüksége lehet rá.

**Figyelmeztetési és biztonsági előírások** Kérjük, feltétlenül olvassa el a gyártó által megadott használati utasításokat A használati útmutató, többek között, a következőket tartalmazza részletesebben:

1. Az ágy összeszerelési folyamata során, győződjön meg az ágy összekötő részeinek biztonságos és szakszerű összeillesztéséről. Célszerű az összekötő részeket a jövőben is (a használati időtartam alatt), folyamatosan ellenőrizni.
2. Az ágyat nem lehet használni ha annak valamely része hiányos vagy esetleg törött.
3. Az ágyra tilos a következő tárgyakat ráilleszteni kötelek, kábelek, fűzők, szíjak stb. ! Fennáll az esetleges fuldoklási veszély kockázata!
4. Az ágy mögötti esetleges penészképződés és a z ágy körülötti nem kívánatos kellemetlen szagok megelőzése érdekében, kérjük, biztosítsa a helység megfelelő szellőzését, egyidejűleg megfelelő szintű páratartalmát is.

#### Kezelési útmutatás:

Az ágyat kizárólag nedves ronggyal tisztítjuk

- ID azonosító; Tárolóágy STEFAN 90
- Furnér

Krevet trebaju sastavljati dvije osobe.

(HR)

#### Važno!

Molimo Vas da pažljivo pročitate upute za upotrebu, koje sadrže i upute upozorenja i sigurnosti prije početka sastavljanja kreveta. Čuvajte ih za sljedeću upotrebu.

#### Upute upozorenja i sigurnosti:

Molimo Vas da obavezno slijedite instrukcije proizvođača. Detaljnije, tu je uključeno:

1. Pri sastavljanju kreveta, budite sigurni da su elementi za povezivanje pravilno pričvršćeni. Isto tako, pričvršćenost elemenata za povezivanje treba nadzirati i prilikom upotrebe.
2. Krevet se ne može koristiti ako nedostaje neki dio ili ako je razbijen.
3. Sljedeći predmeti ne smiju se stavljati ili vješati na krevet konop, žice, kabel, vezice, pojas... Postoji opasnost od davljenja !!
4. Molimo Vas da zapamtite da prostorija treba biti potpuno prozračena radi održavanja niske razine vlage u zraku, čime bi se zaustavilo stvaranje plijesni unutar, i oko kreveta.

#### Upute za održavanje:

Krevet treba održavati samo vlažnom krpom

- ID identifikator ; Krevet za odlaganje STEFAN 90
- Iverica

**DE** Montageanleitung Stauraumbett **STEFAN 90**  
**EN** Assembly instructions Storage Bed **STEFAN 90**  
**NL** Montage-instructies Opbergbed **STEFAN 90**  
**FR** Instructions de montage Lit coffre **STEFAN 90**

**SK** Montážne pokyny Úložná posteľ **STEFAN 90**  
**CZ** Návod k montáži Úložné lůžko **STEFAN 90**  
**HU** Szerelési útmutató Tárolóágy **STEFAN 90**  
**HR** Upute za montažu Krevet za odlaganje **STEFAN 90**

Date 29.05.2024

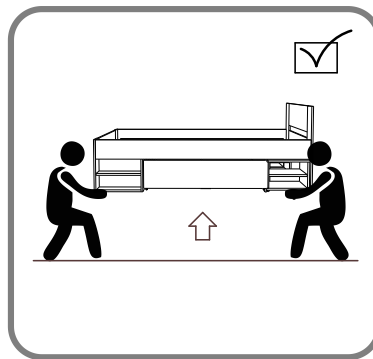
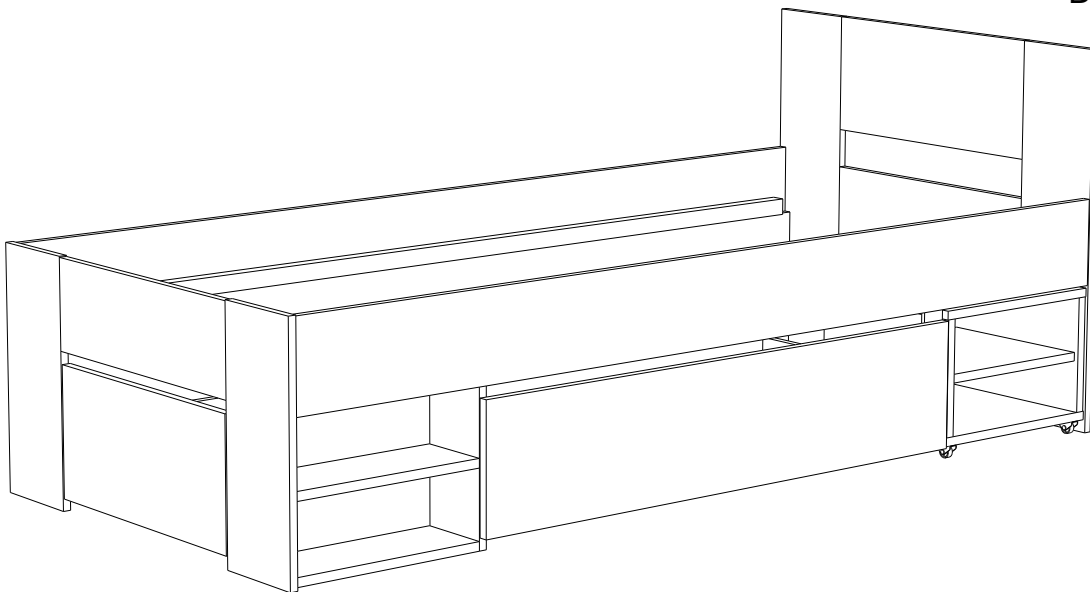

**DE Wichtiger Hinweis:**  
Bett nicht schieben, nur angehoben umstellen.

**EN Important information:**  
Do not shove the bed, move it only by lifting.

**NL Belangrijke opmerking:**  
Het bed niet schuiven, alleen verplaatsen door opheffen.

**FR Information importante:**  
Ne pas pousser le lit, il faut le porter pour déplacer.

**SK Dôležitá informácia:**  
Posteľ neskladajte, pohybujte iba zdvíhaním.

**CZ Důležitá informace:**  
Nevystrkujte postel, pohybujte pouze zvedáním.

**HU Fontos információ:**  
Ne lökd be az ágyat, csak emeléssel mozgassa.





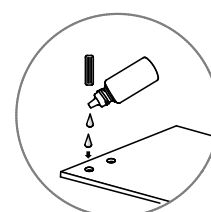
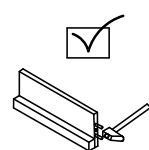
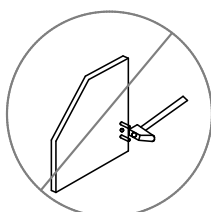
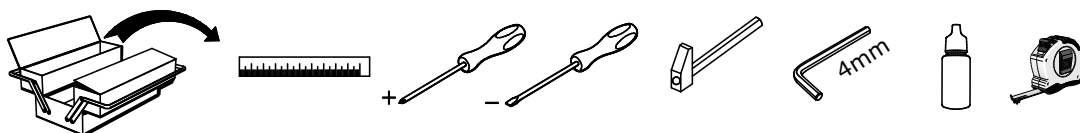
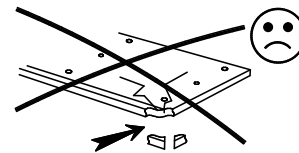
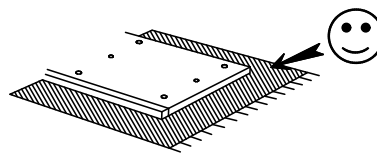
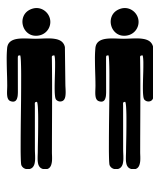











**HR Važna informacija:**  
Ne gurajte krevet, pomičite ga samo podizanjem.

🕒 1:30'



# STAURAMBETT STEFAN 90

<b>DE</b> Anleitungen für die Montage	<b>EN</b> Instructions for the assembly	<b>NL</b> Instructies voor de montage	<b>FR</b> Instructions de montage
<b>SK</b> Pokyny na montáž	<b>CZ</b> Pokyny pro montáž	<b>HU</b> Utasítások az összeszereléshez	<b>HR</b> Upute za sastavljanje

<b>A</b>  x 13	<b>B</b>  $\varnothing 15 \times 12.5 /$ x 21	<b>C</b>  $\varnothing 8 \times 35$ x/44	<b>D</b>  M 7 x 50 /x 14	<b>E</b>  /x 4	<b>F</b>  $\varnothing 3.5 \times 16$ /x 39	<b>G</b>  $\varnothing 4 \times 40$ /x 20
<b>H</b>  x12	<b>I</b>  x 1	<b>J</b>  30 x 30 /x 2	<b>K</b>  $\varnothing 4 \times 30$ /x 9	<b>L</b>  glue /x 1	<b>M</b>  x 1	<b>N</b>  $\varnothing 4 \times 20$ /x 6
<b>O</b>  x 2	<b>P</b>  x 2					

Date 29.05.2024

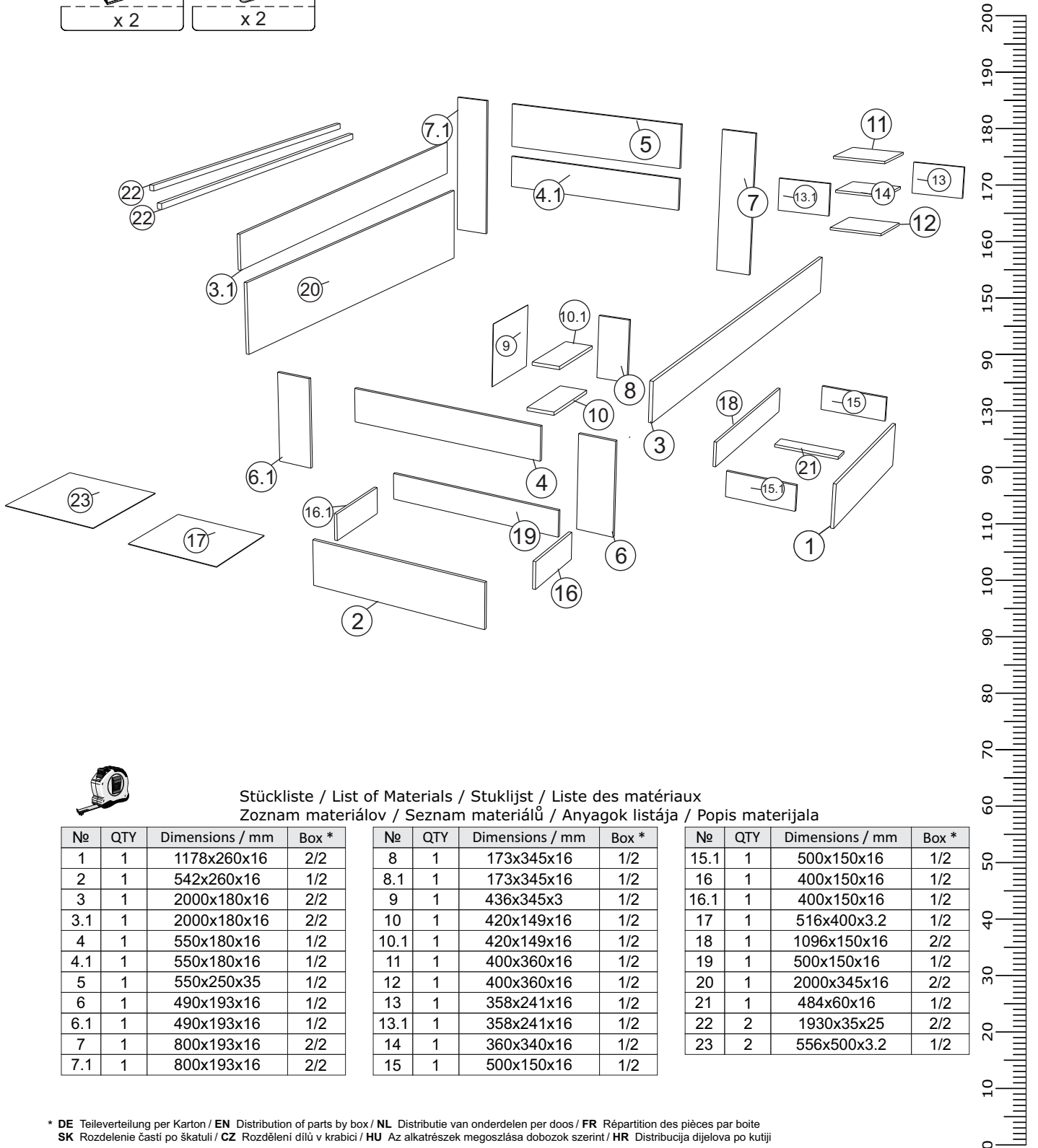

Stückliste / List of Materials / Stuklijst / Liste des matériaux  
Zoznam materiálov / Seznam materiálu / Anyagok listája / Popis materijala

Nº	QTY	Dimensions / mm	Box *	Nº	QTY	Dimensions / mm	Box *	Nº	QTY	Dimensions / mm	Box *
1	1	1178x260x16	2/2	8	1	173x345x16	1/2	15.1	1	500x150x16	1/2
2	1	542x260x16	1/2	8.1	1	173x345x16	1/2	16	1	400x150x16	1/2
3	1	2000x180x16	2/2	9	1	436x345x3	1/2	16.1	1	400x150x16	1/2
3.1	1	2000x180x16	2/2	10	1	420x149x16	1/2	17	1	516x400x3.2	1/2
4	1	550x180x16	1/2	10.1	1	420x149x16	1/2	18	1	1096x150x16	2/2
4.1	1	550x180x16	1/2	11	1	400x360x16	1/2	19	1	500x150x16	1/2
5	1	550x250x35	1/2	12	1	400x360x16	1/2	20	1	2000x345x16	2/2
6	1	490x193x16	1/2	13	1	358x241x16	1/2	21	1	484x60x16	1/2
6.1	1	490x193x16	1/2	13.1	1	358x241x16	1/2	22	1	1930x35x25	2/2
7	1	800x193x16	2/2	14	1	360x340x16	1/2	23	2	556x500x3.2	1/2
7.1	1	800x193x16	2/2	15	1	500x150x16	1/2				

\* DE Teileverteilung per Karton / EN Distribution of parts by box / NL Distributie van onderdelen per doos / FR Répartition des pièces par boîte  
SK Rozdelenie časti po škatuli / CZ Rozdělení dílů v krabici / HU Az alkatrészek megoszlása dobozok szerint / HR Distribucija dijelova po kutiji

\*\* DE Matratze / EN Mattress / NL Matras / FR Matelas / SK Matrace / CZ Matrace / HU Matrac / HR Madrac



# STAURAUMBETT STEFAN 90

1

G  20 st.



Positioning and securing of the bed side slats

10Min.

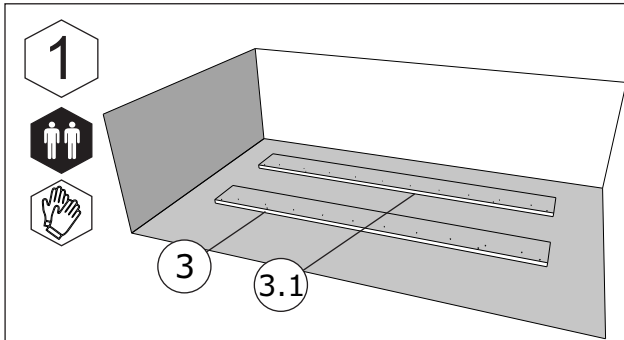

Put the side panels of the bed on ground facing backside and make sure that there is nothing below the panel

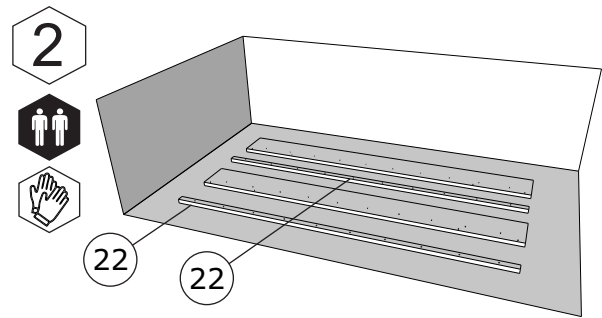

Put the left panel of the bed on ground facing frontside and make make sure that there is nothing below the panel

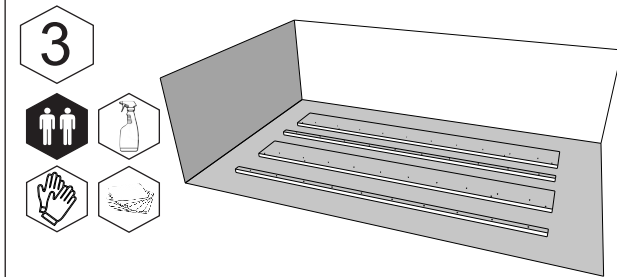

Make sure that left side panel of the bed and right side panel of the bed are clean from dust, dirt and oil.

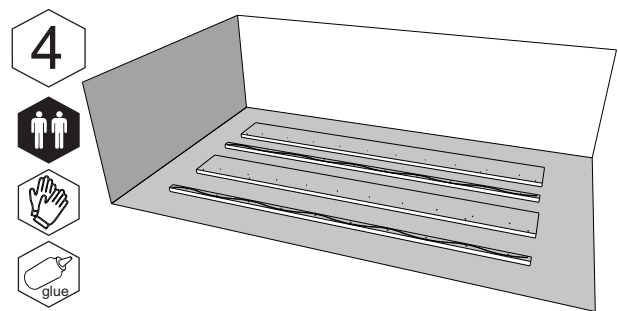

Make sure that all panels that you need to apply glue to are clean from dust, dirt and oil and then apply glue on them.

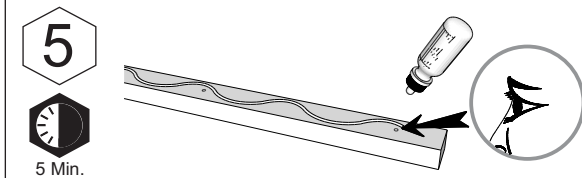

Make sure that you apply the glue from right side and wait 5min. for glue to cure.

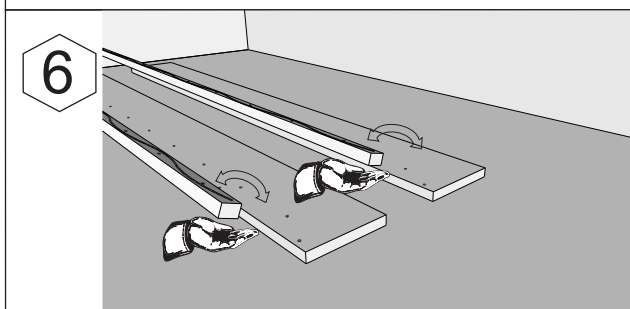
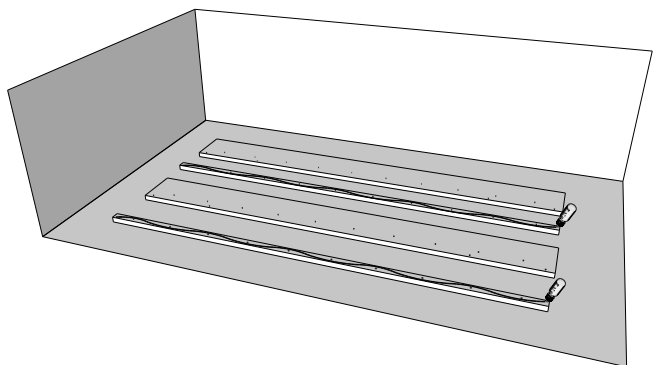

Gently turn over all panels that you apply glue on and place them on right position.

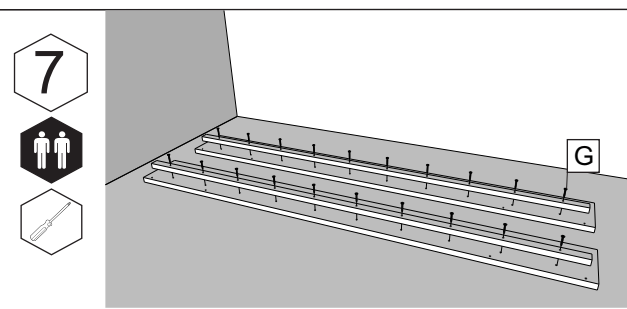







Gently apply pressure on the surface of the panels and secure them with screws.  
**IMPORTANT:**  
Full cure time of the glue is 12 hours!

7/16



# STAURAUMBETT STEFAN 90

**2**

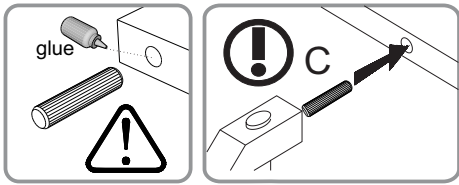
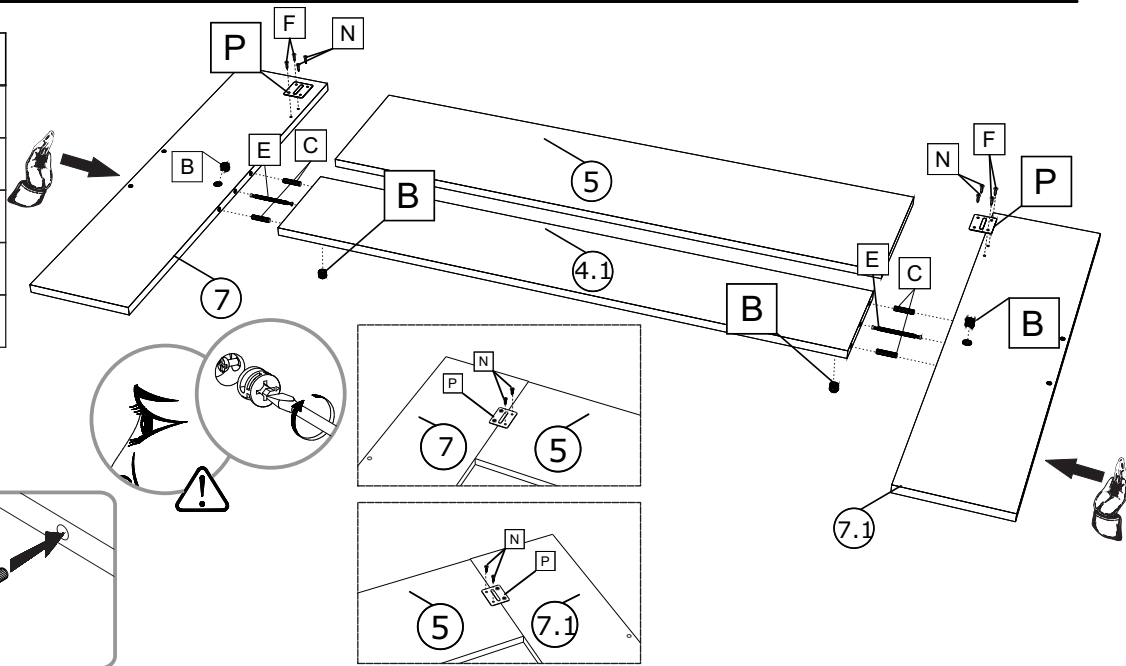
E		2 st.
C		4 st.
B		4 st.
P		2 st.
F		4 st.
N		4 st.



**3**

C		8 st.
B		4 st.
A		4 st.

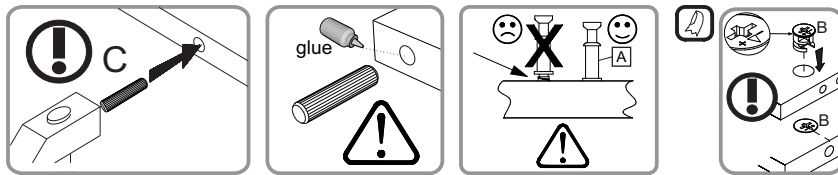
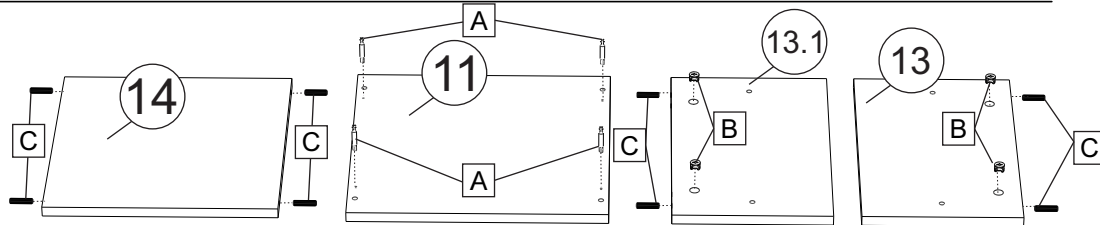

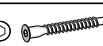

**4**

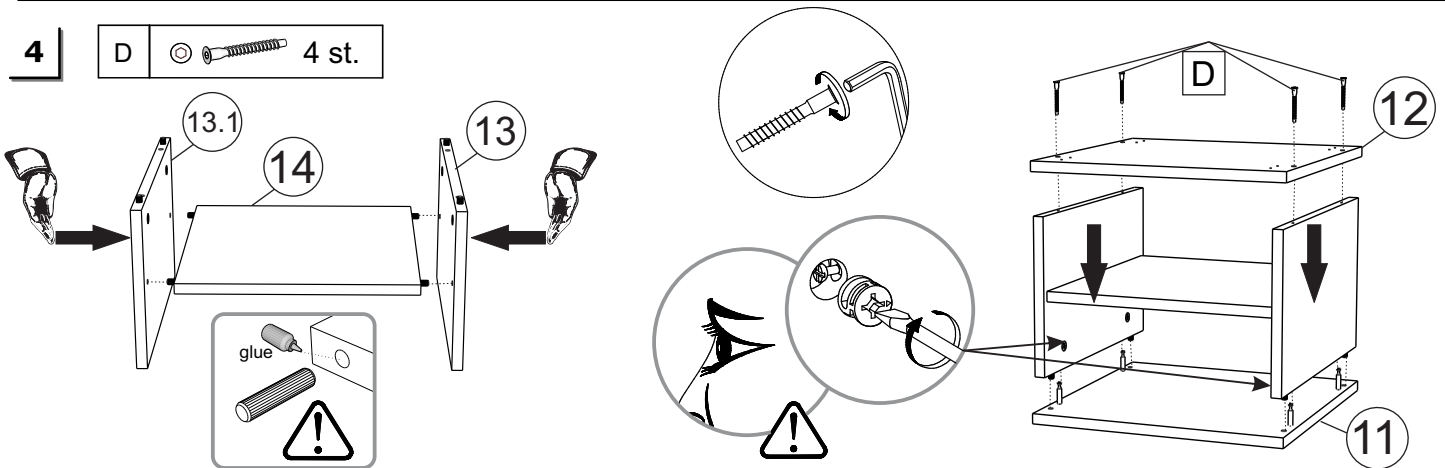
D		4 st.
---	---	-------



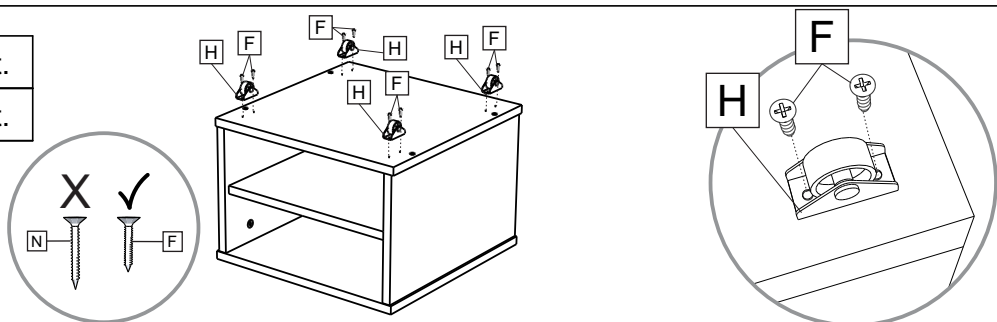

**5**

H		4 st.
F		8 st.



# STAURAMBETT STEFAN 90

6

A		2 st.
B		2 st.
C		8 st.

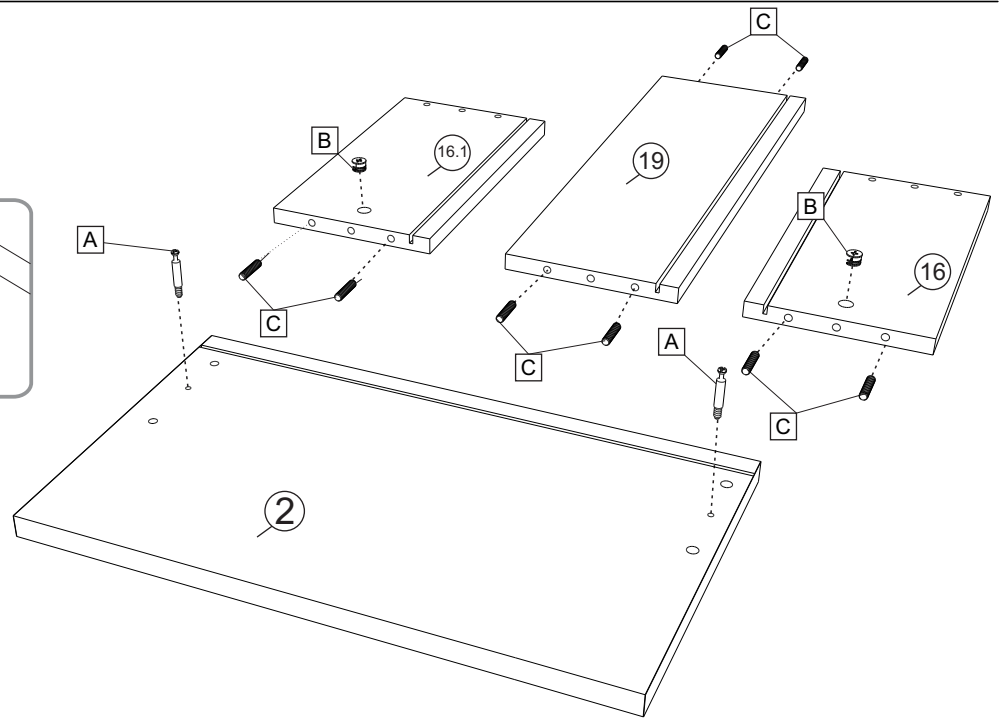
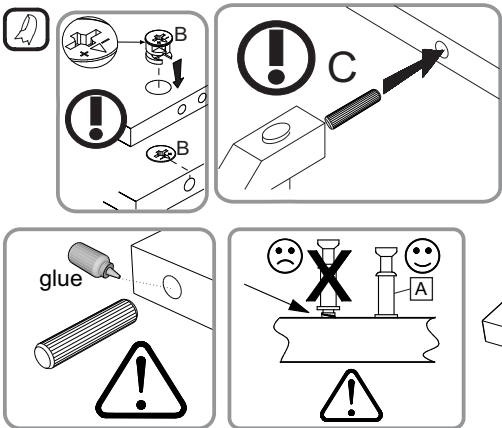

7

E		2 st.
---	---	-------

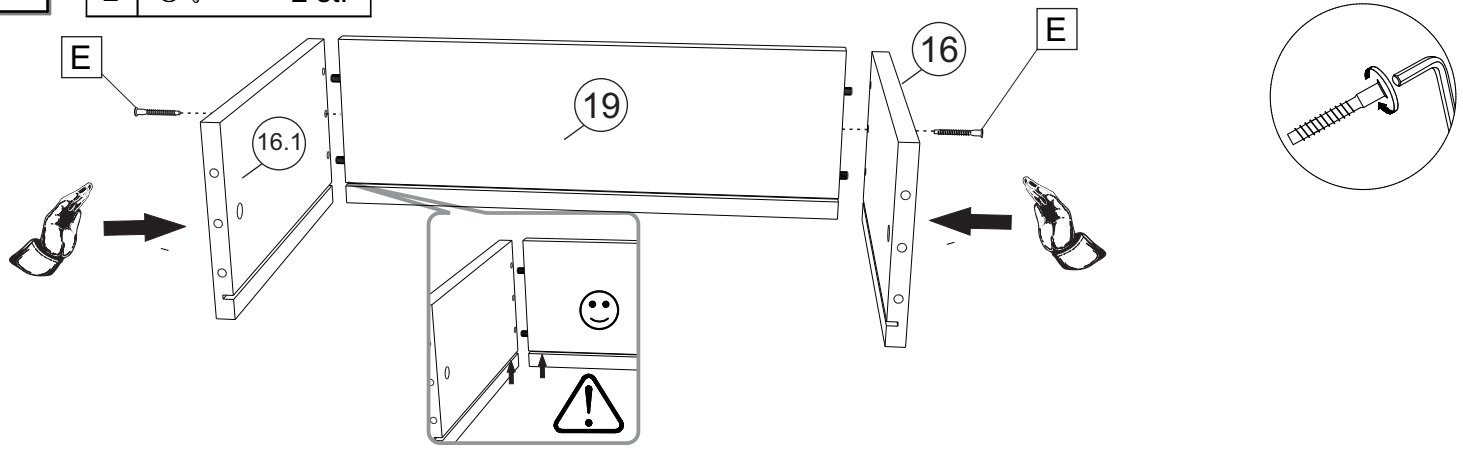

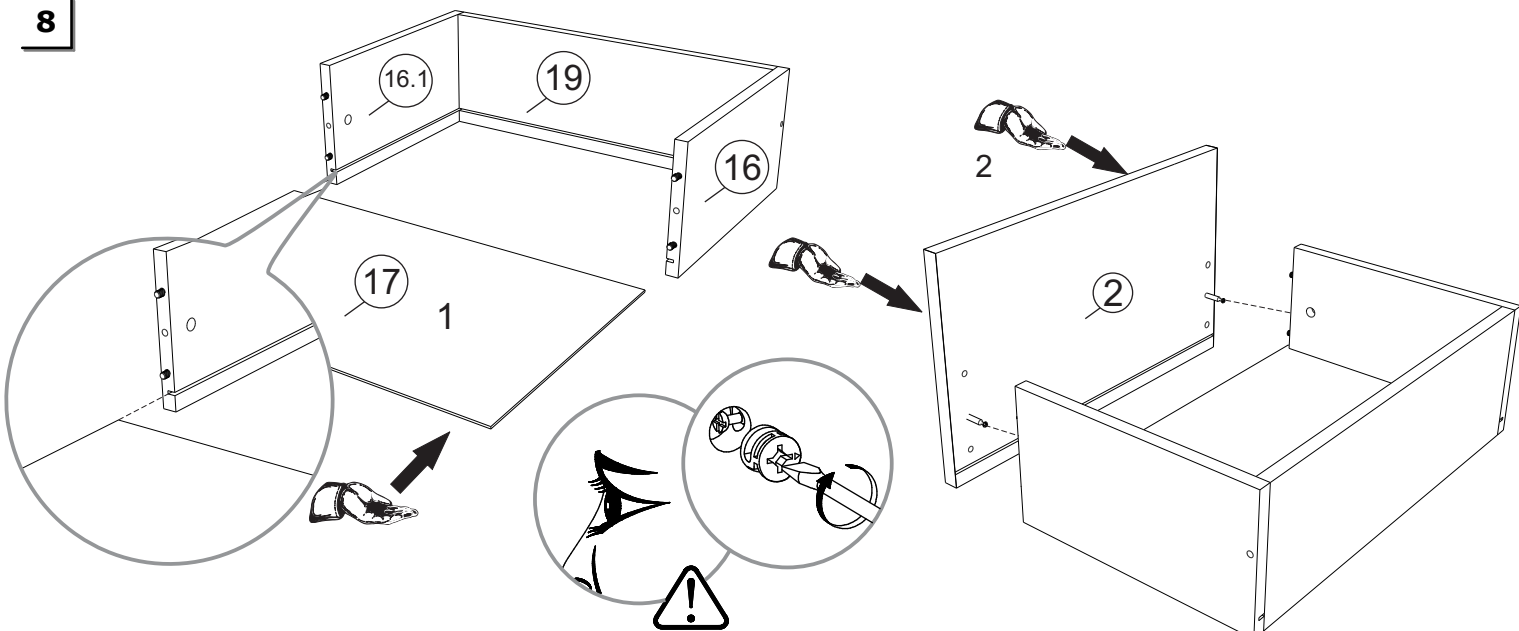

8



# STAURAUMBETT STEFAN 90

9

A		2 st.
B		2 st.
C		12 st.

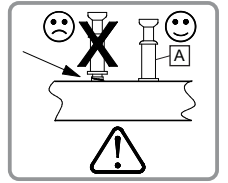
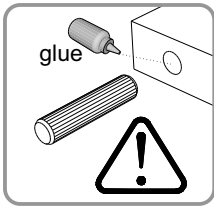
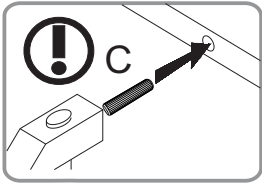
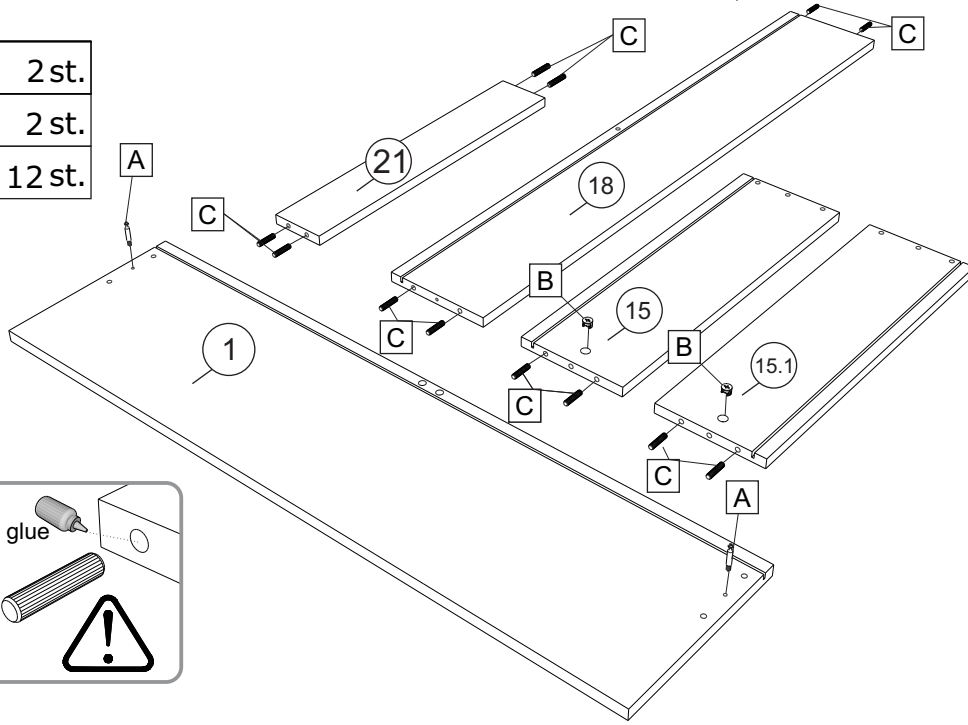

10

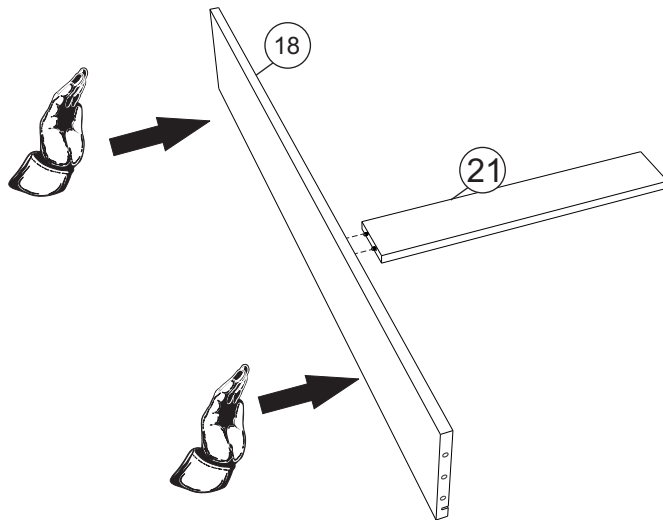

11

D		2 st.
---	---	-------

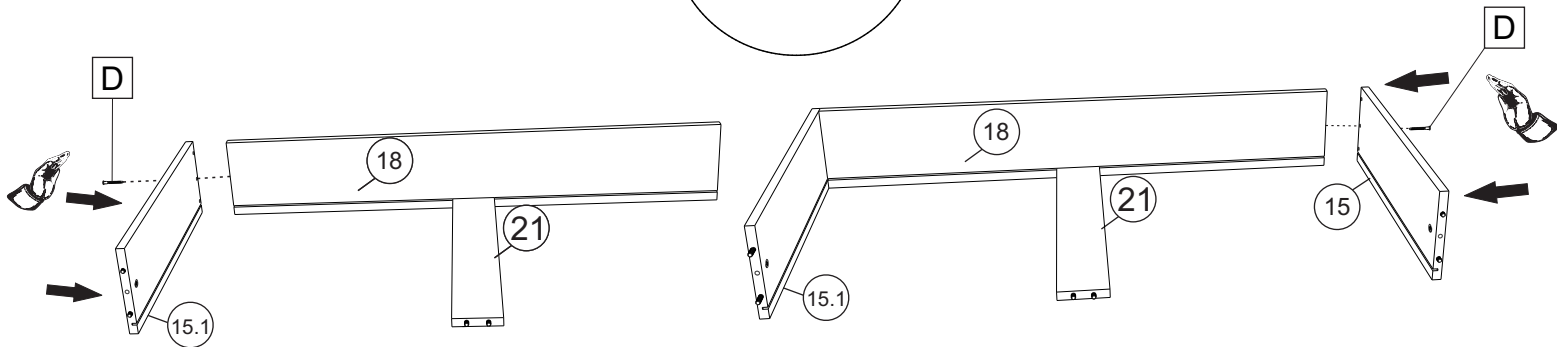
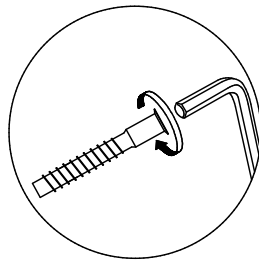

# STAURAMBETT STEFAN 90

12

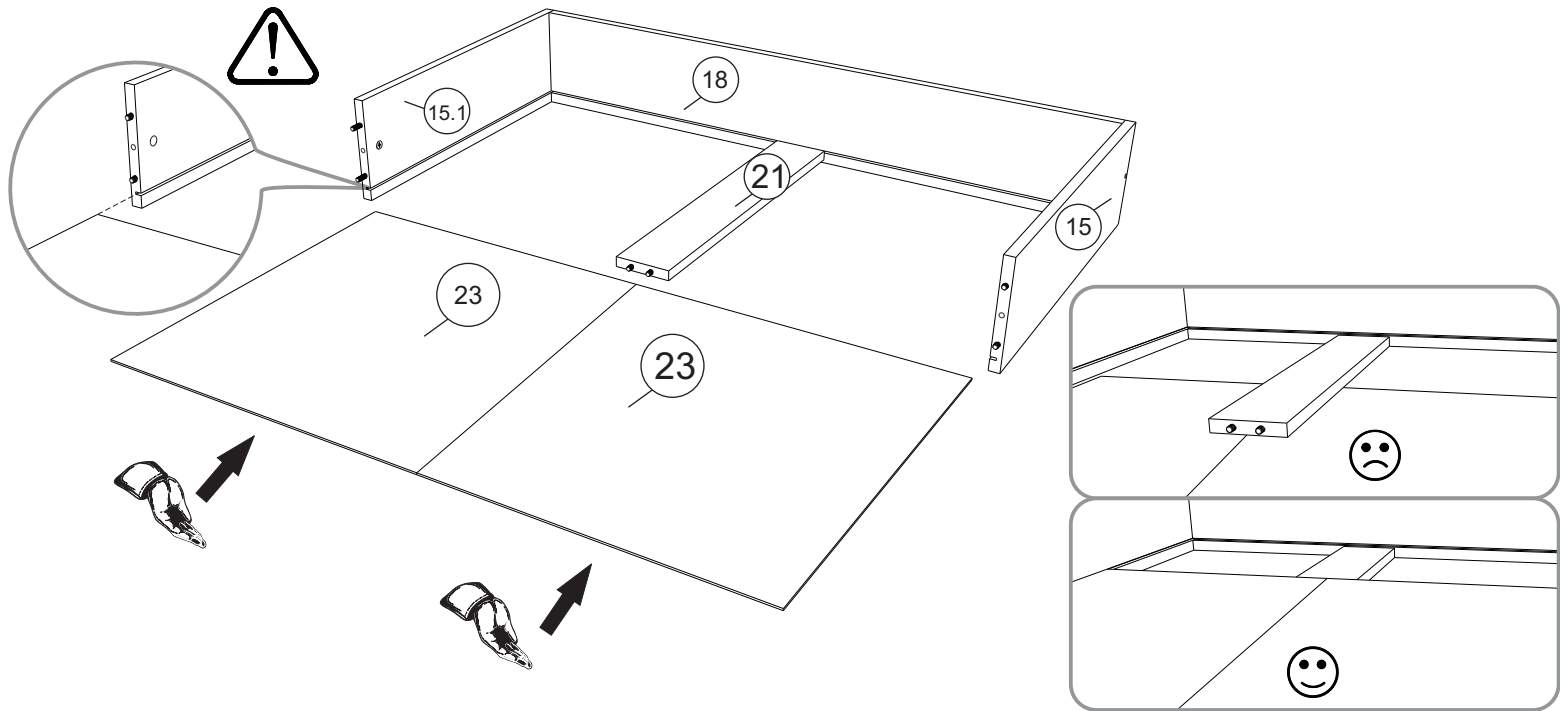

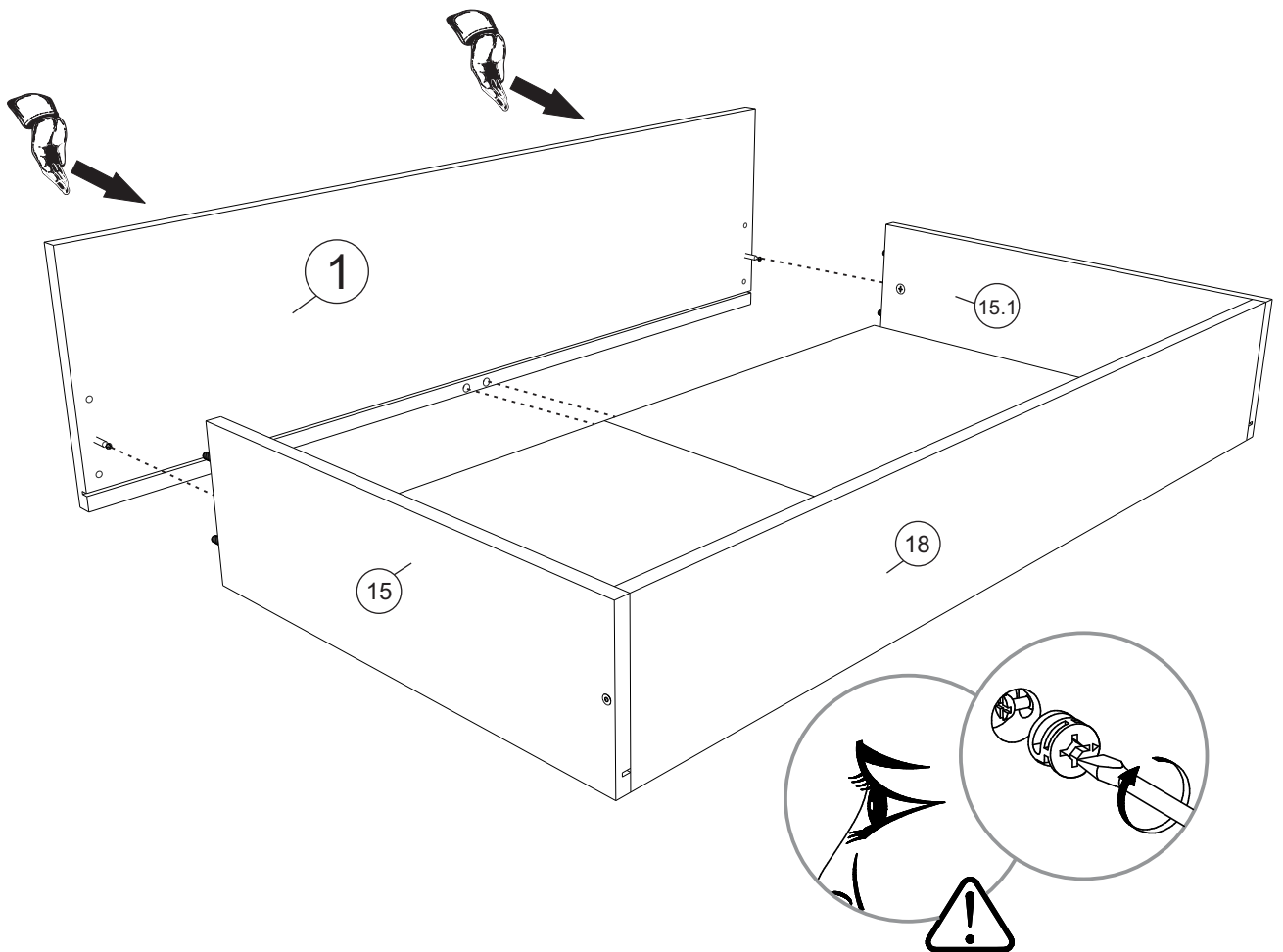

13



# STAURAMBETT STEFAN 90

**14**



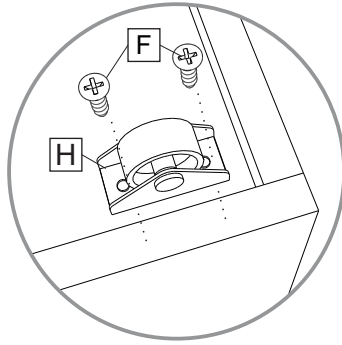

H		8st.
F		16st.

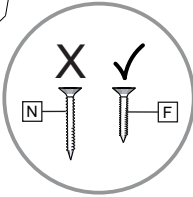
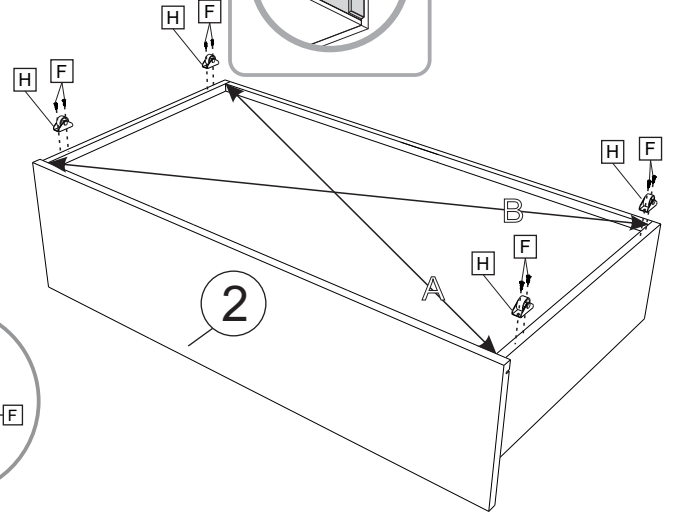
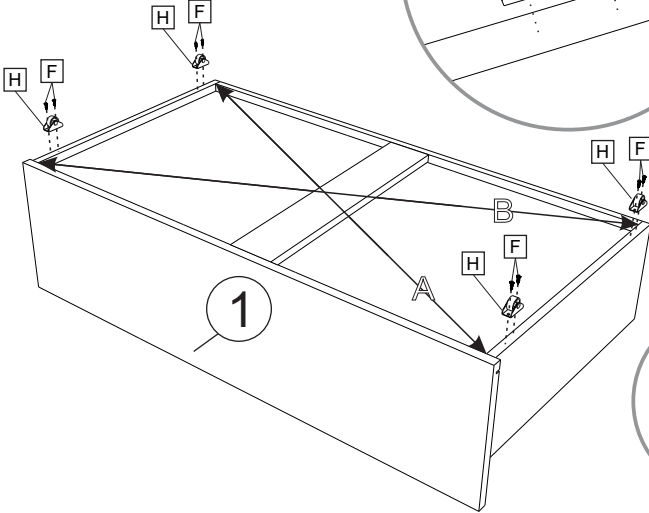
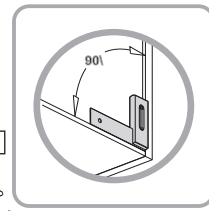

 A=B!



**15**

A		1 st.
C		4 st.
B		2 st.
K		9 st.

## Variant 1

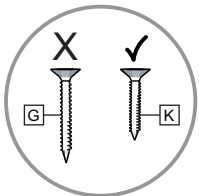
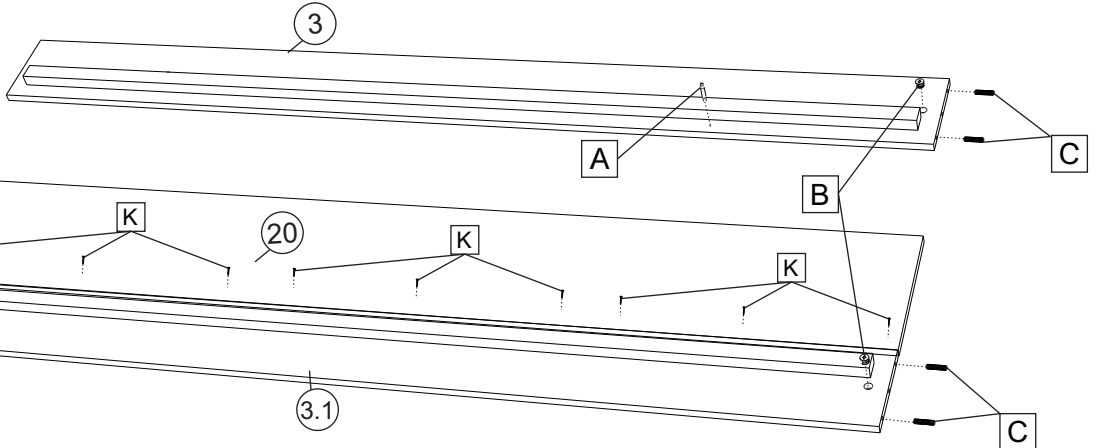

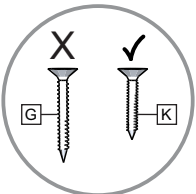
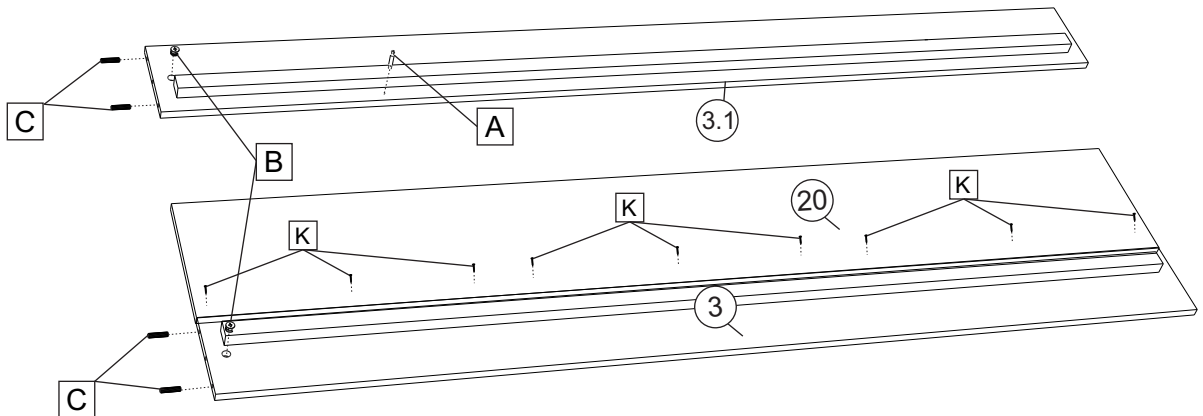

## Variant 2





# STAURAMBETT STEFAN 90

**16**

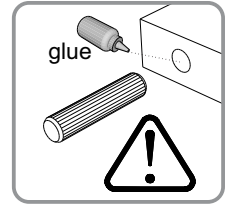
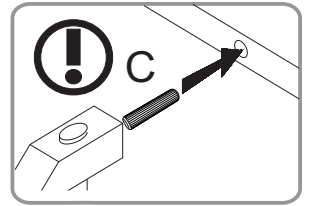
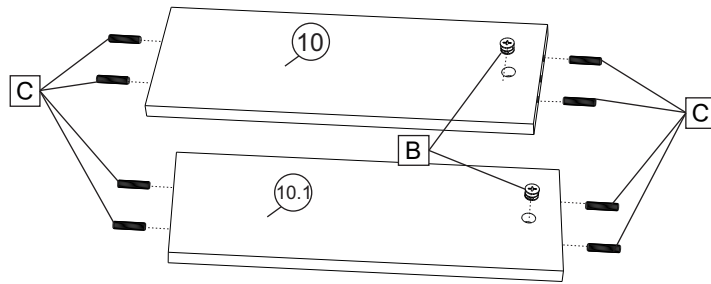
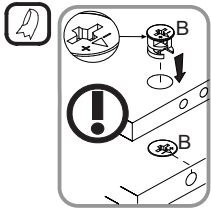
C		8 st.
B		2 st.



**17**

A		3 st.
B		2 st.

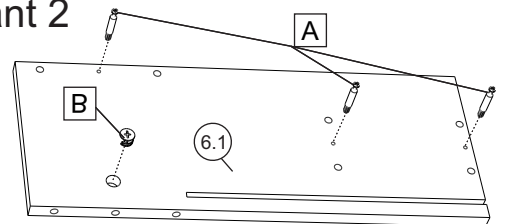
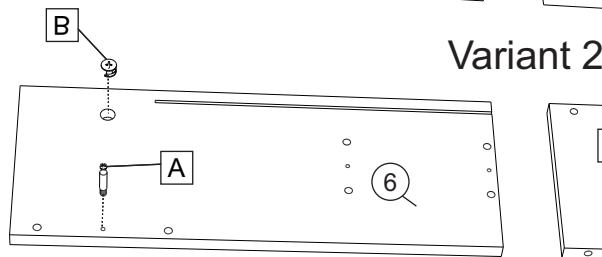
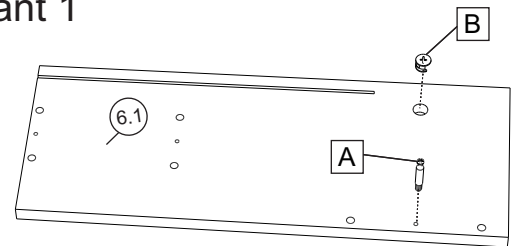
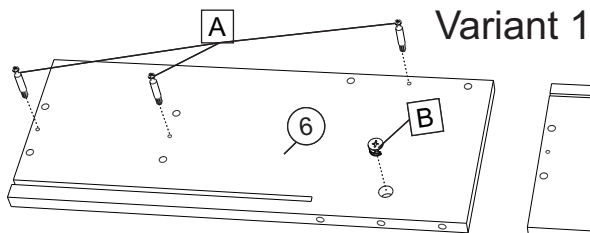
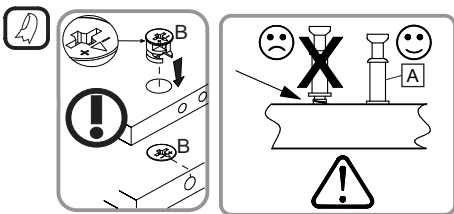



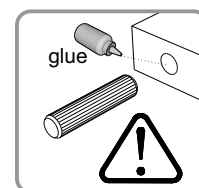
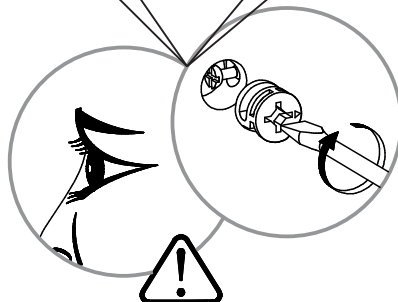
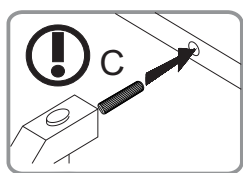
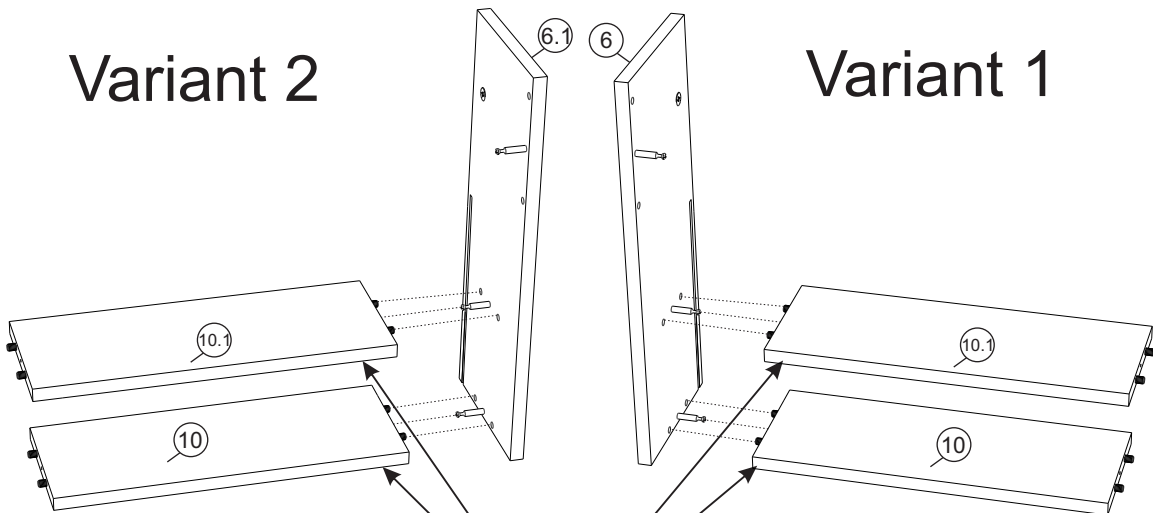

**18**

<b>Variant 2</b>	<b>Variant 1</b>
------------------	------------------



# STAURAMBETT STEFAN 90

<b>19</b>	D		2 st.
	N		2 st.
	I		1 st.
	B		1 st.

## Variant 1

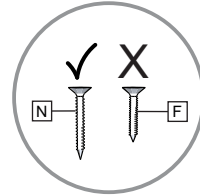
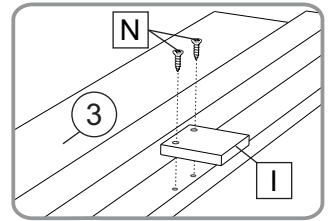
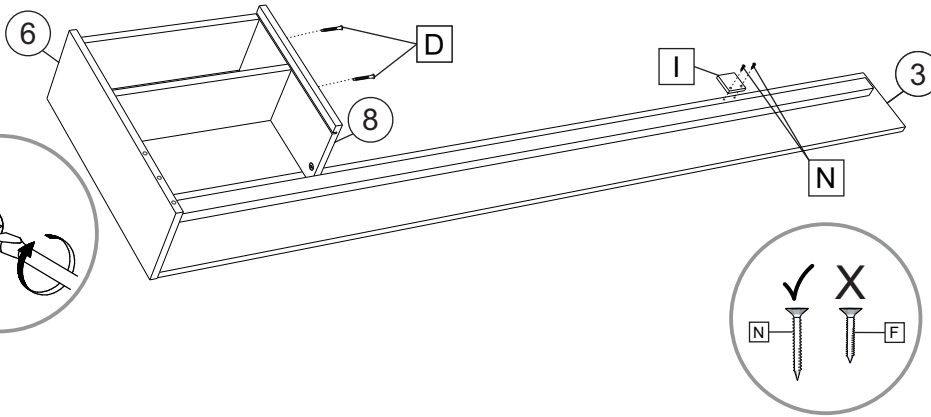
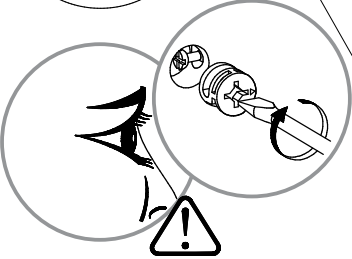
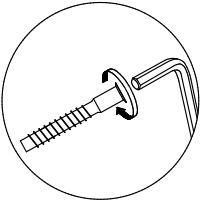
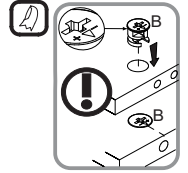
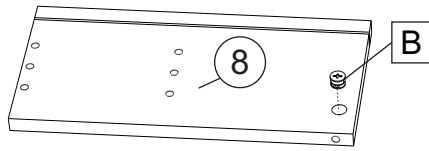

## Variant 2

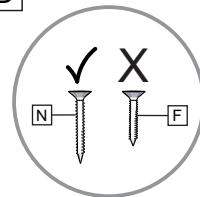
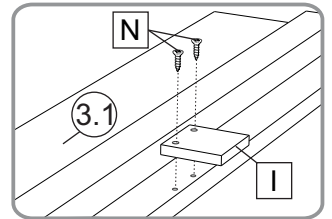
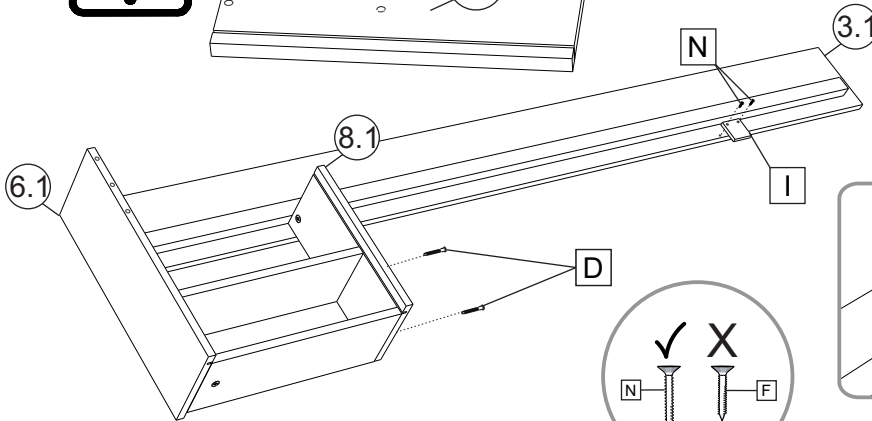
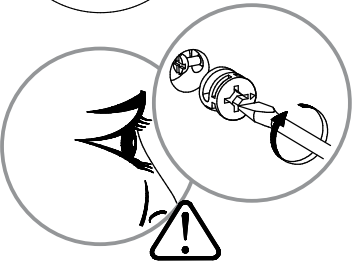
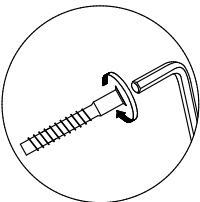
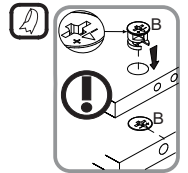
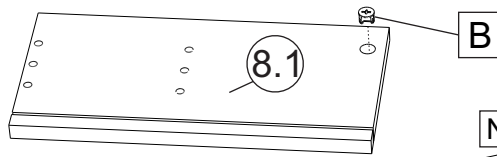

<b>20</b>	F		1 st.
-----------	---	---	-------

## Variant 1

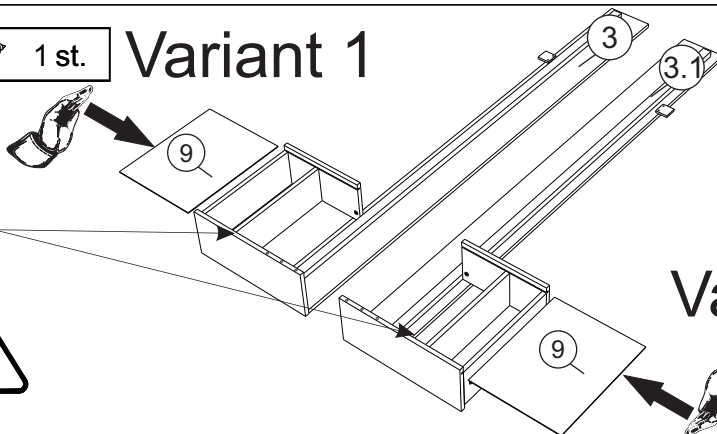
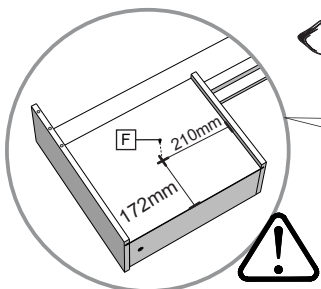
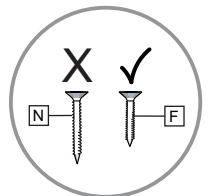



## Variant 2





# STAURAMBETT STEFAN 90

21

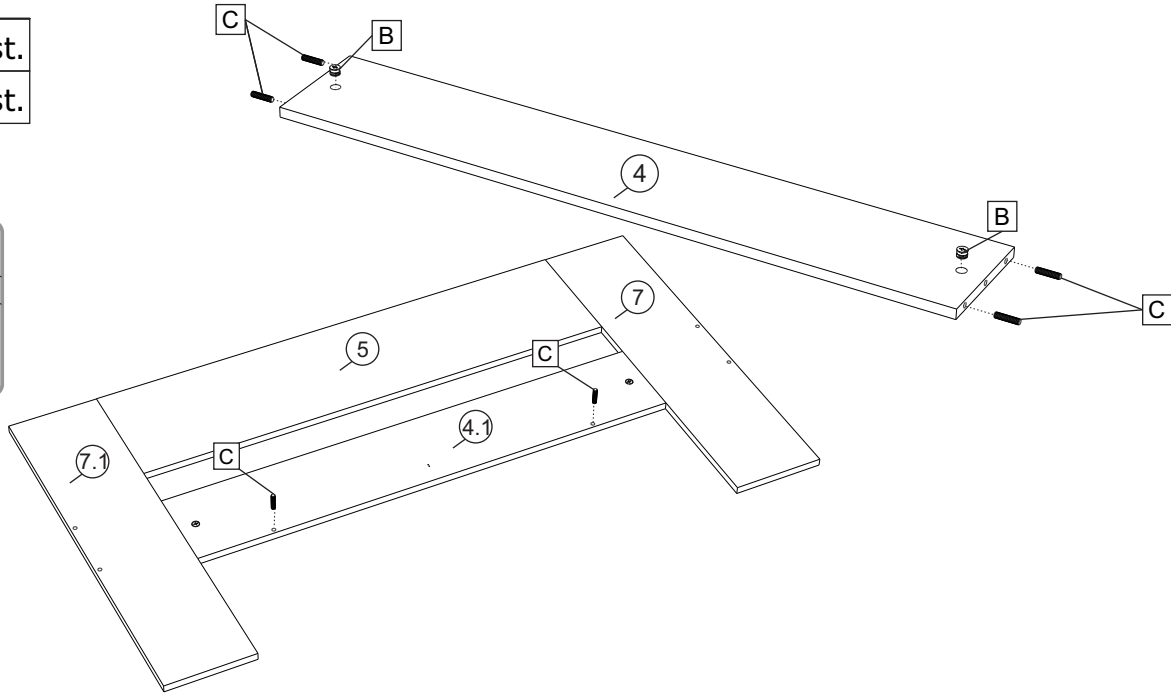
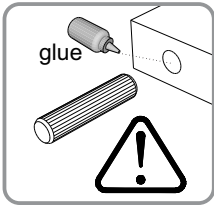
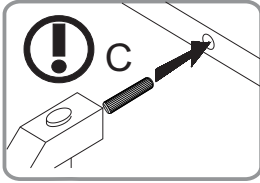
C		6 st.
B		2 st.

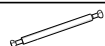

22

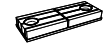
E		2 st.
F		2 st.
O		2 st.

Variant 1

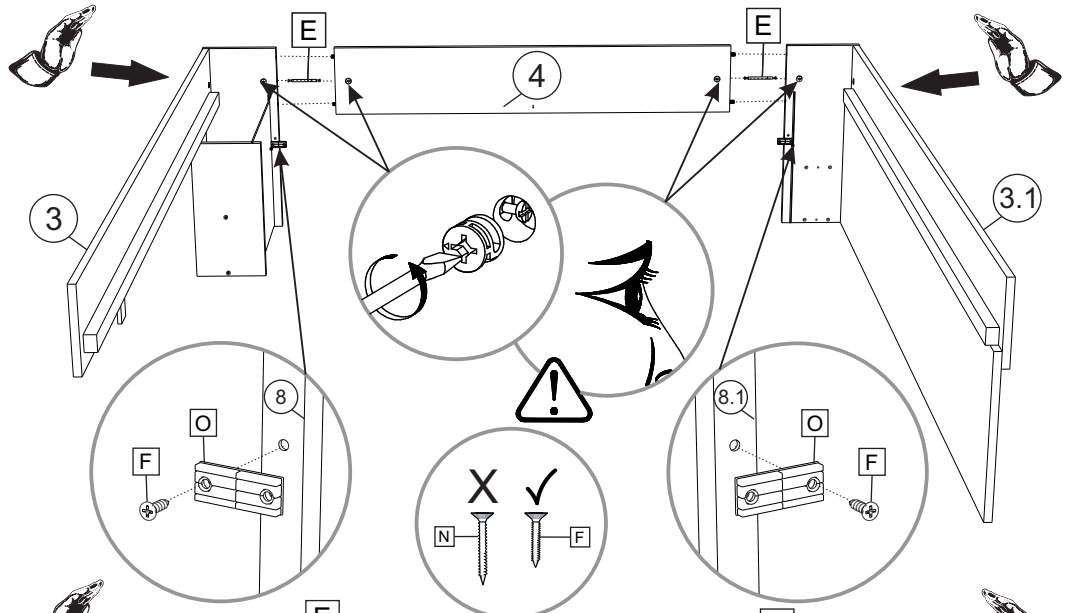

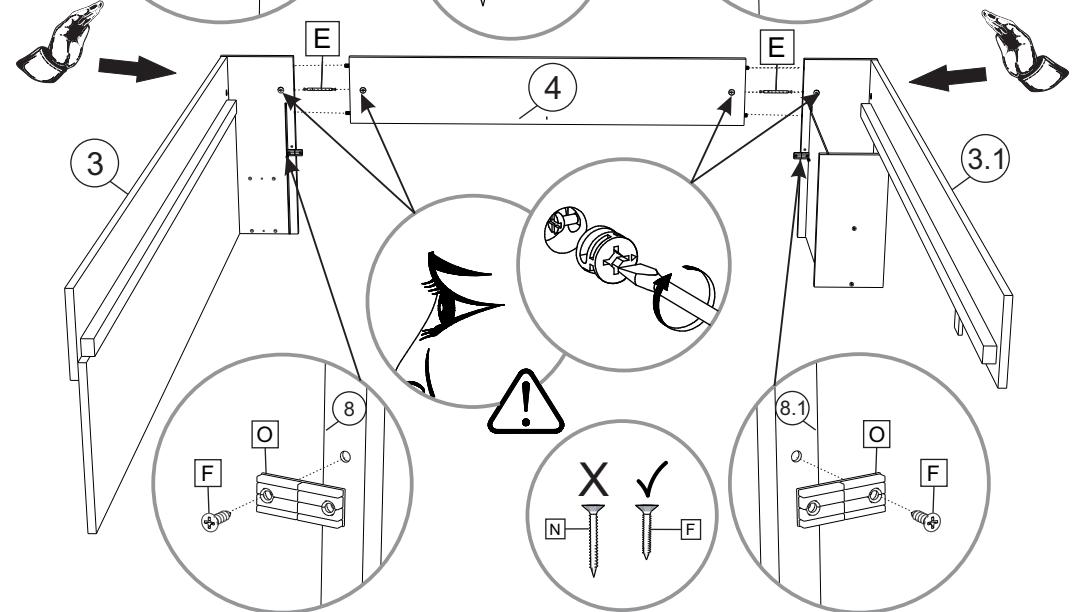

Variant 2



# STAURAMBETT STEFAN 90

## Variant 1

23

D		4 st.
J		2 st.
F		8 st.

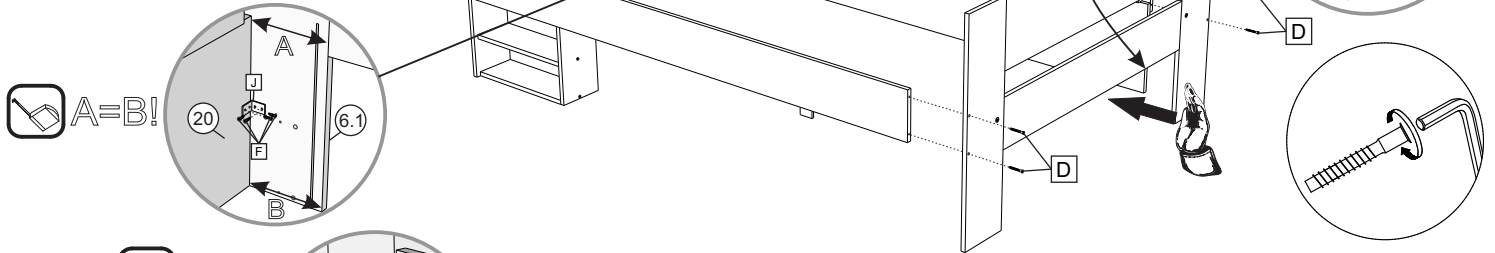

## Variant 2

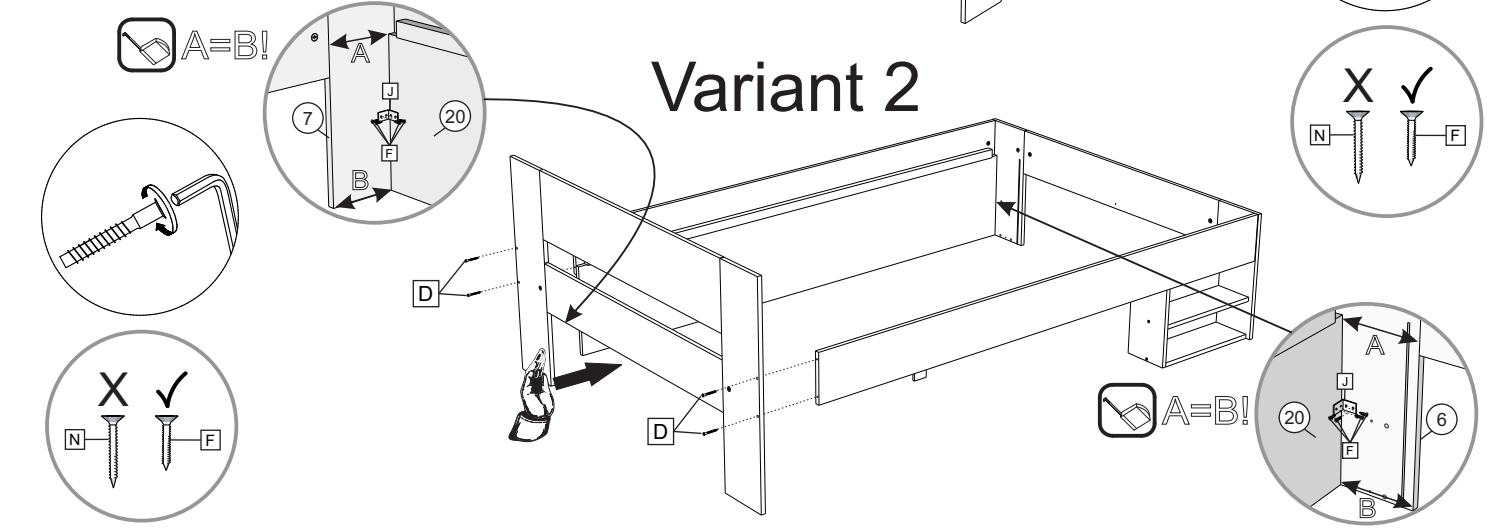

24

## Variant 1

## Variant 2

