



(D) Videounterstützte Montageanleitung

(TR) Video destekli kurulum talimatları

(RU) инструкция по монтажу с помощью видеосигнала

(RO) Instrucțiuni de instalare acceptate video

(GB) Video-assisted assembly instructions

(IT) Istruzioni di montaggio video-assistite

(CZ) Instalační pokyny podporované videem

(PL) Instrukcje montażu wspomagane sygnałem wizyjnym

(FR) Instructions de montage assistées par vidéo

(NL) Video-ondersteunde montage-instructies

(HU) Video-támogatott telepítési utasítások

(SK) Inštalčné pokyny podporované videom

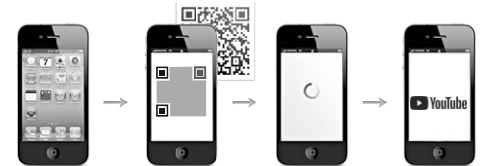
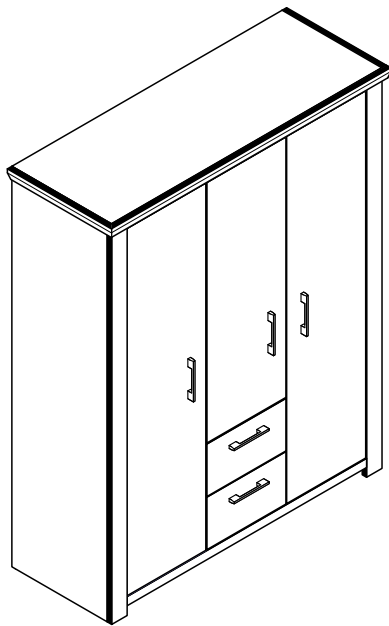

Art.-Nr.: **0442-KS_32**
Kleiderschrank

REPC-Nr.:

Service • Assistenza • Dienstverlening • Serwis
Servis • Szerviz • Сервисная служба

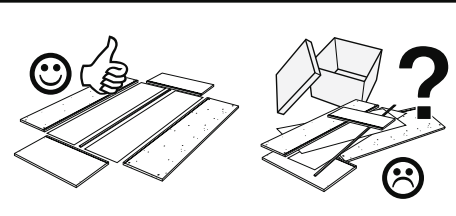
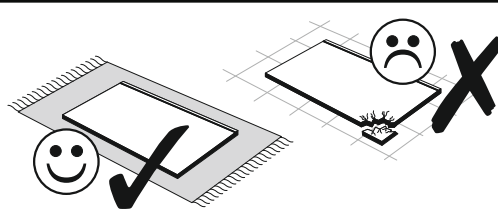
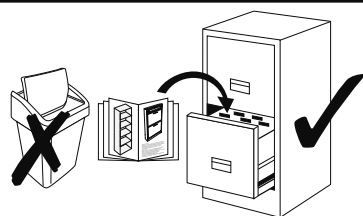
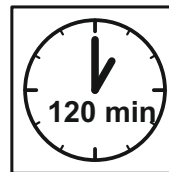
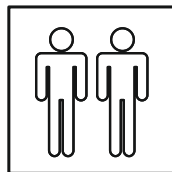
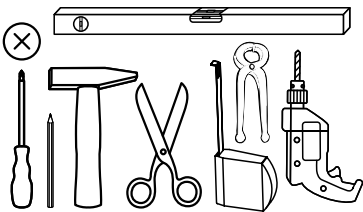

SCAN ME

Das Ersatzteil-Anforderungsformular finden Sie auf
The replacement parts requisition form you find on
<https://www.maeusbacher.de/ersatzteile/>

Beutel 0442-KS_32 0-13 Colli 3/3

B01-10 4x 6,3x50	B01-30 60x 3x16	B01-37 1x 4,5x25	B01-70 4x 3x30	B01-80 26x 3,5x13
B01-90 6x 3,5x20	B01-200 8x 6,3x13	B01-329 10x M4x22	B02-08 8x h=10mm	B02-10 43x h=12mm
B02-20 51x	B02-114 4x	B02-160 12x	B03-11 3x	B03-42 3x 8er
				B08-80 1x



Beutel 0442-KS_32 0-23 Colli 3/3

B03-07 3x	B03-63 6x	B03-64 6x
--------------	--------------	--------------

Beutel 0442-KS_32 0-33 Colli 2/3

B03-130 10x	B05-185 6x	B05-190 2x	B06-415 5x
----------------	---------------	---------------	---------------

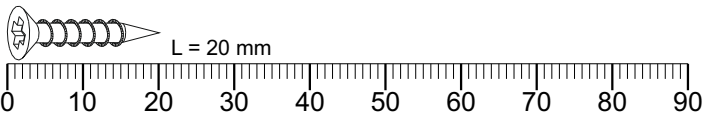

Colli 1/3

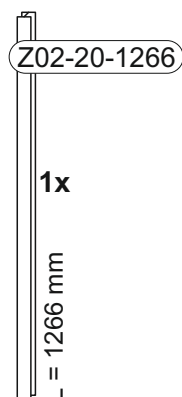
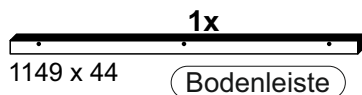
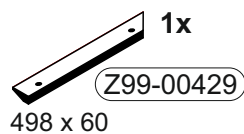
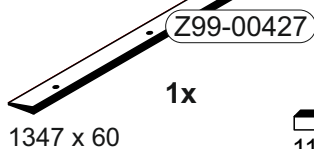
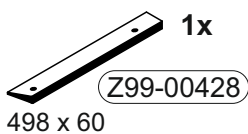
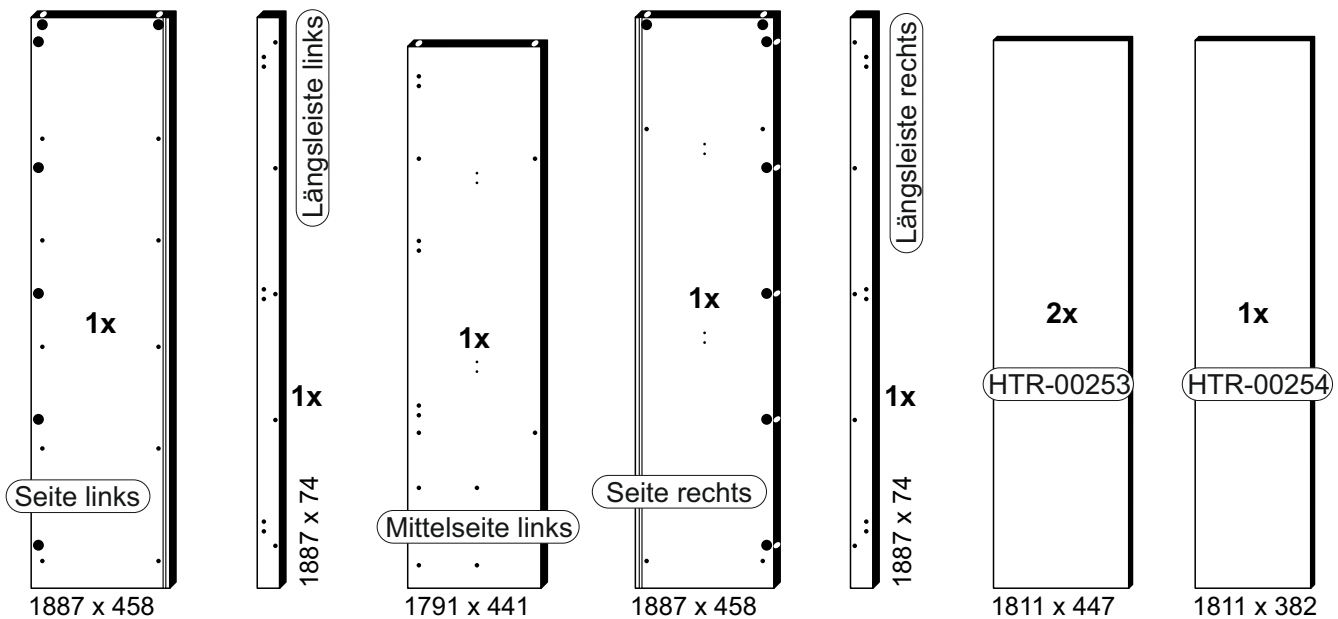

Colli 2/3

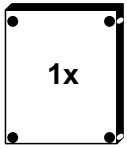

368 x 441

Mittelboden mitte

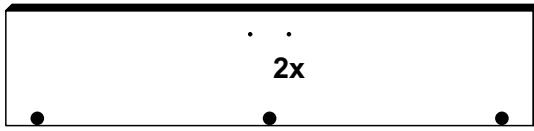

1744 x 380

Türen l+r

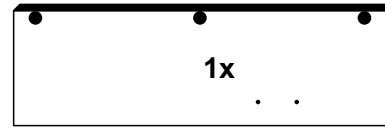

1232 x 380

Türen mitte

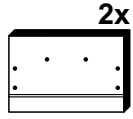

380 x 252

Schubk.-blenden

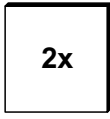

338 x 350

HTS-00019

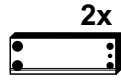

350 x 120

Z01-103-350

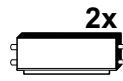

328 x 120

Z01-89-328

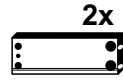

350 x 120

Z01-104-350

Colli 3/3

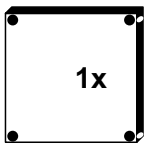

434 x 426

Mittelboden links

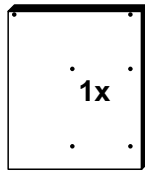

522 x 441

Mittelseite rechts

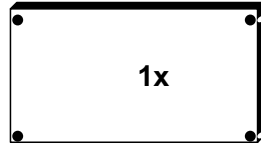

817 x 441

Mittelboden rechts

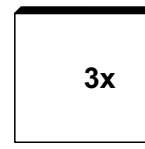

434 x 426

Einlegeboden links

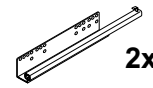

Z01-78L

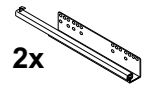

Z01-78R

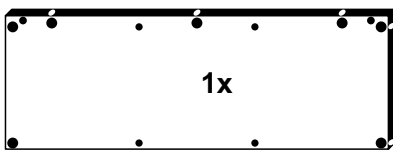

1266 x 441

Boden

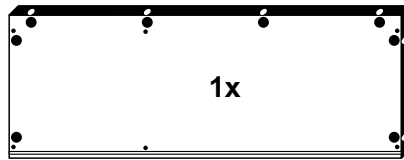

1297 x 473

Oberplatte

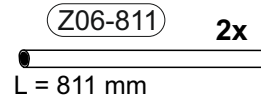

Z06-811

2x

L = 811 mm

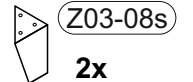

Z03-08s

2x

1

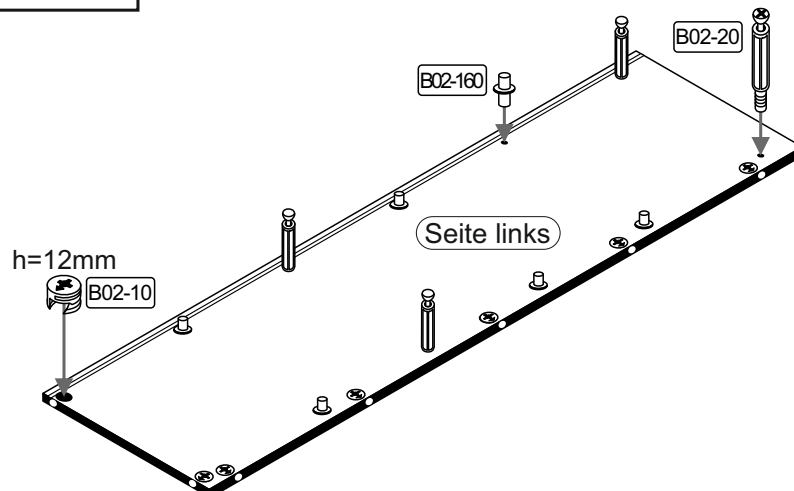
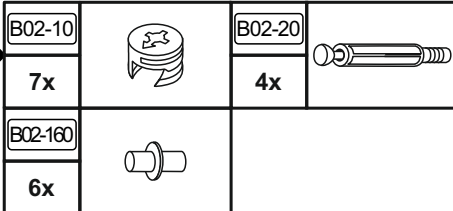

2

B02-20		B03-63	
10x		6x	

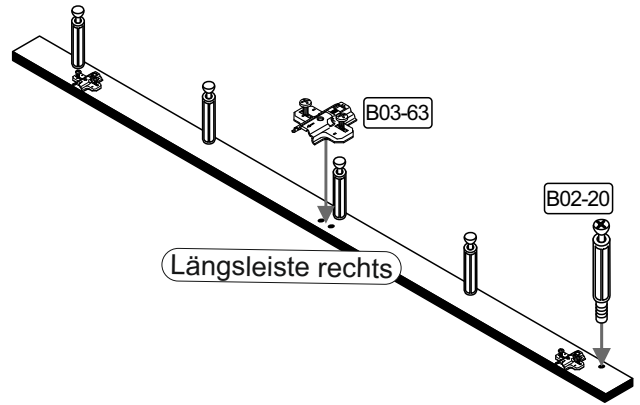
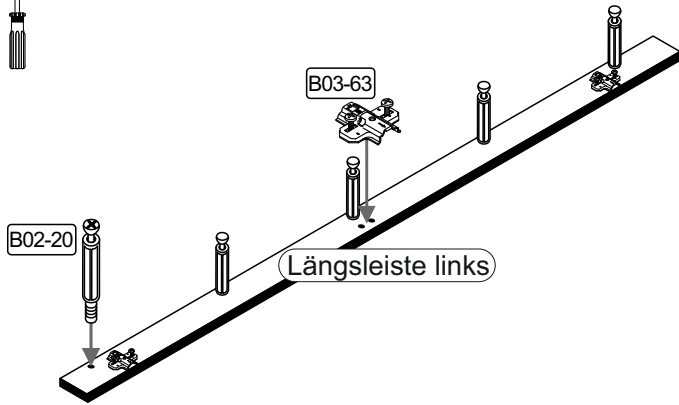

3

B02-10	
4x	

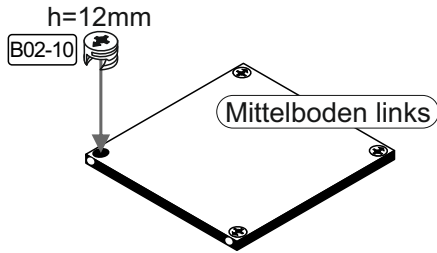

4

B02-10	
4x	

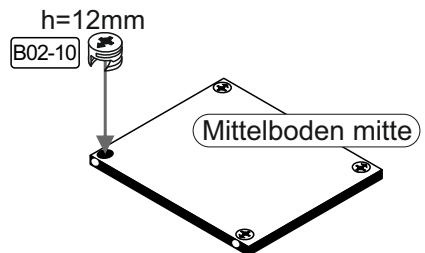

5

B01-80		B01-200		B02-10		B02-20		B02-160	
4x	3,5x13	4x	6,3x13	2x		6x		6x	
				B02-114		B03-11			
				2x		3x			

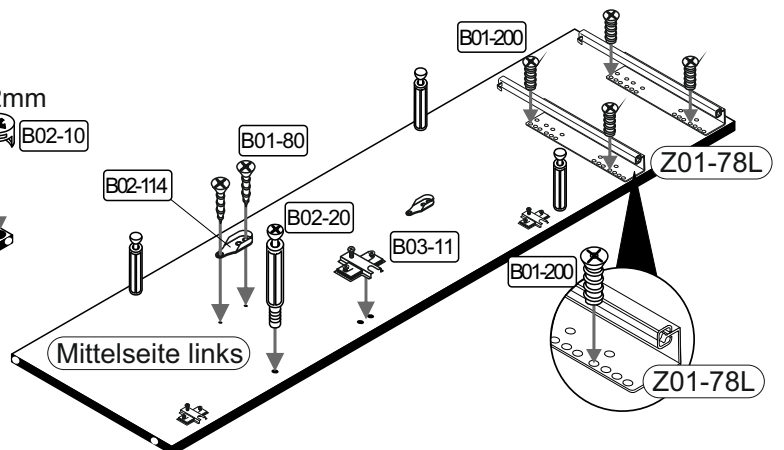
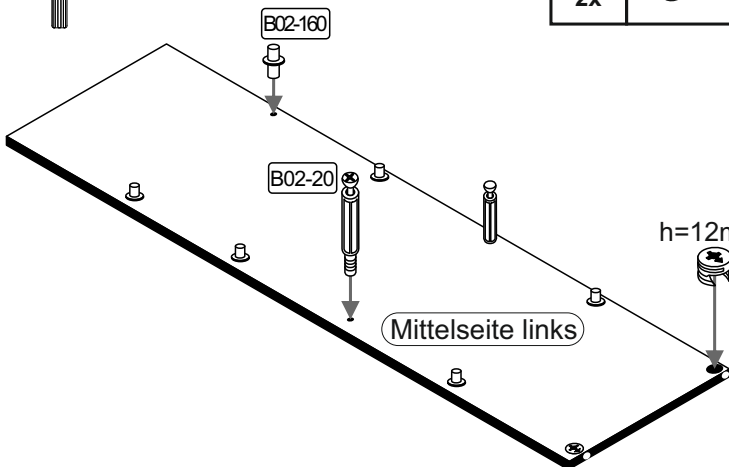

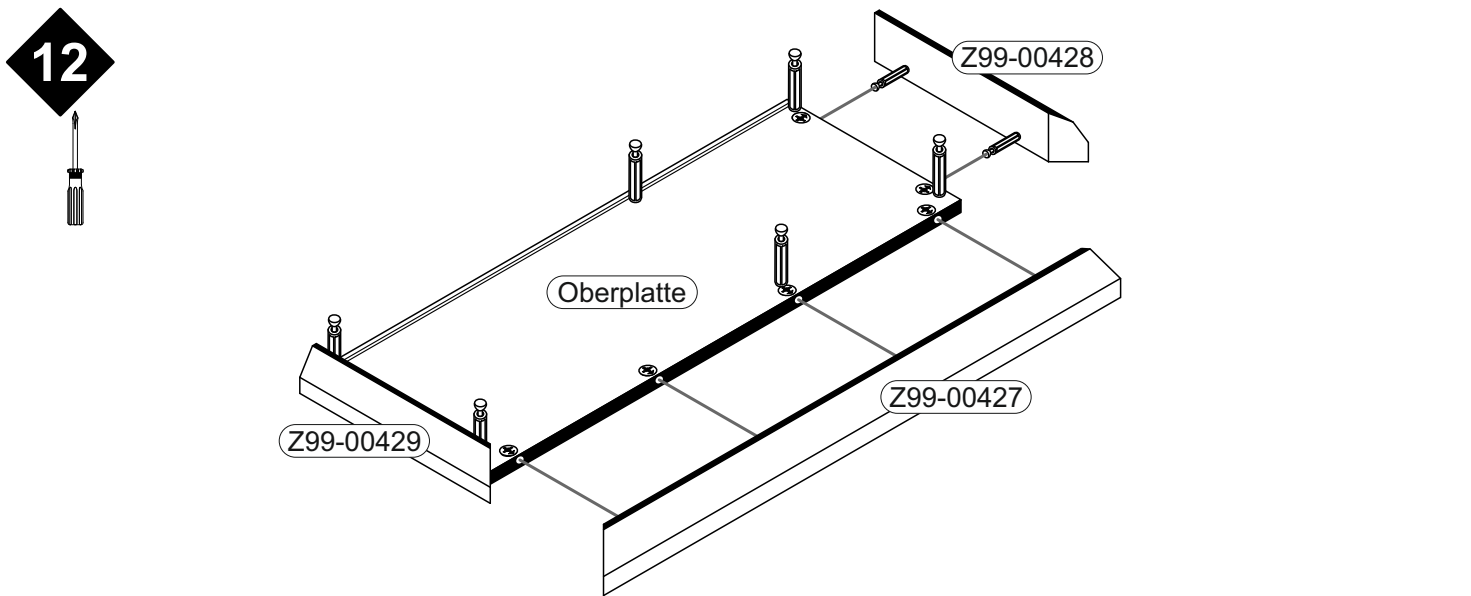
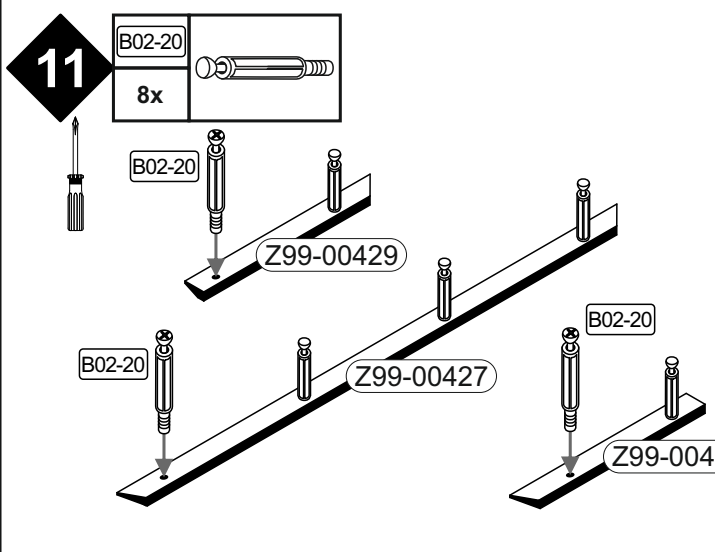
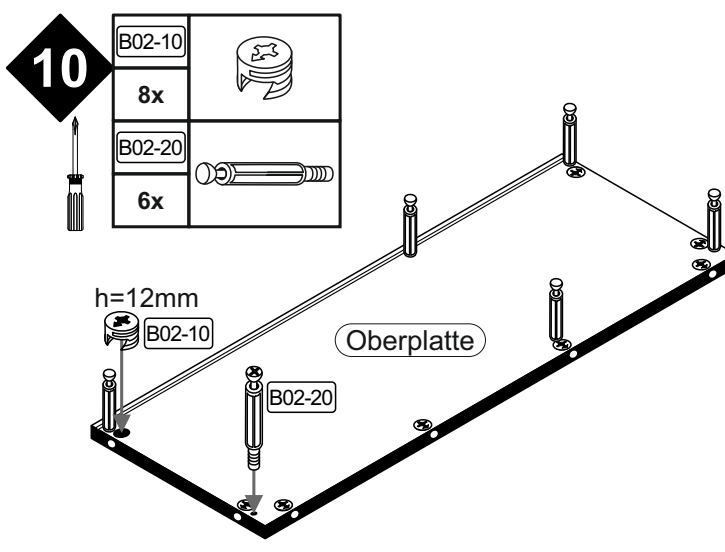
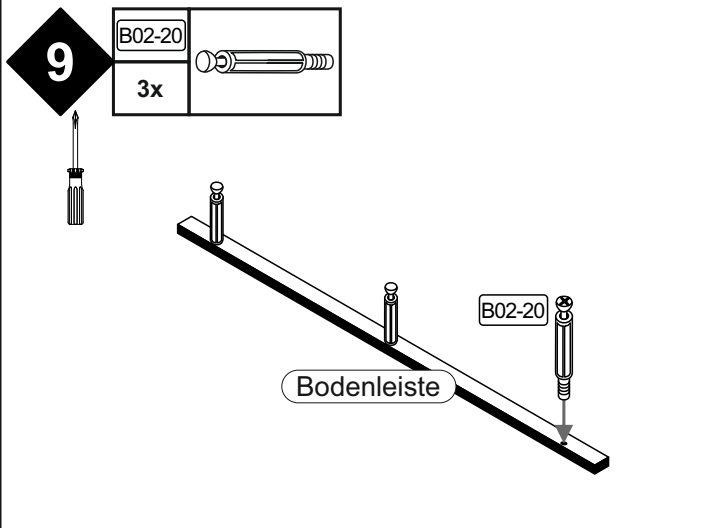
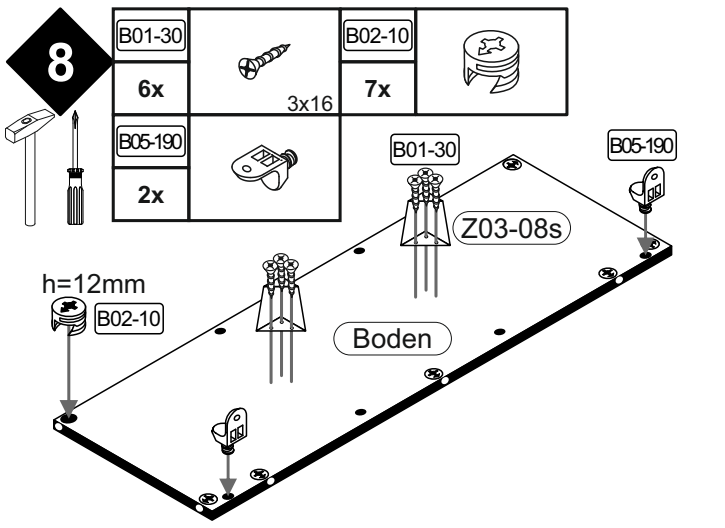
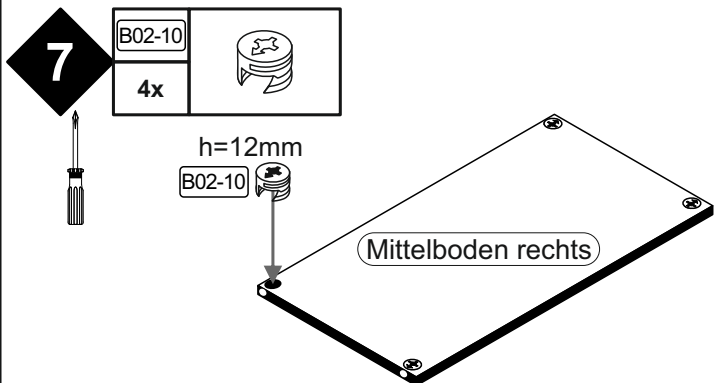
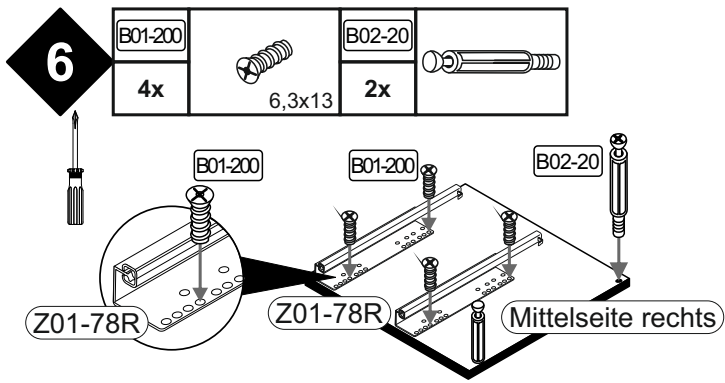

13

B01-80		B02-10	
4x	3,5x13	7x	
B02-20			
4x			
B02-114			
2x			

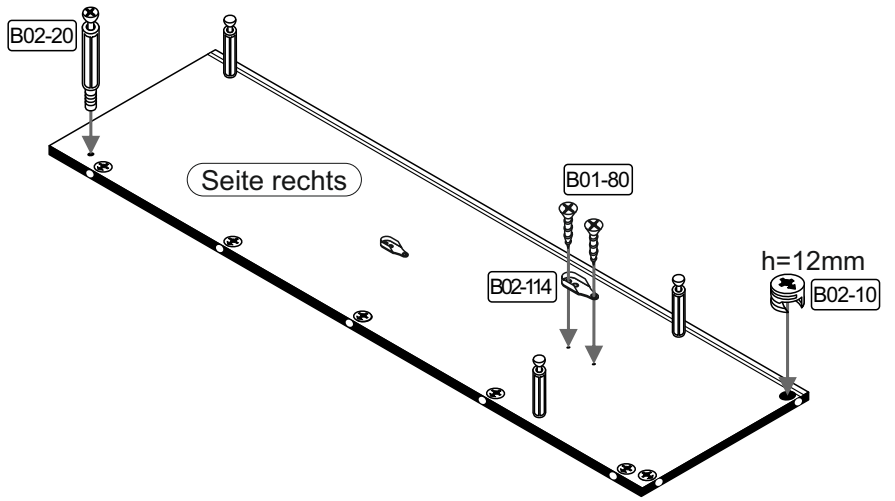

14

B01-37		B01-80		B01-329		B03-42		B03-64		B06-415	
1x	4,5x25	18x	3,5x13	6x	M4x22	3x	8er	6x		3x	

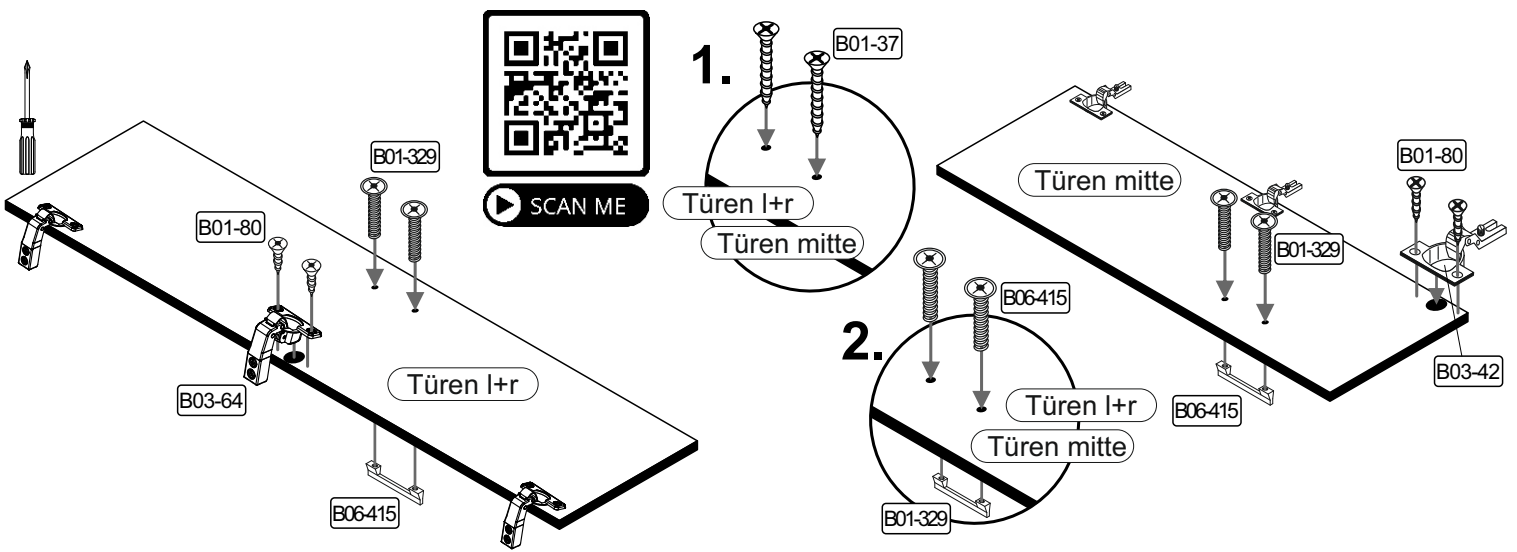

15

B01-37		B01-329		B02-08		B02-20		B03-130		B06-415	
1x	4,5x25	4x	M4x22	8x		8x		4x			

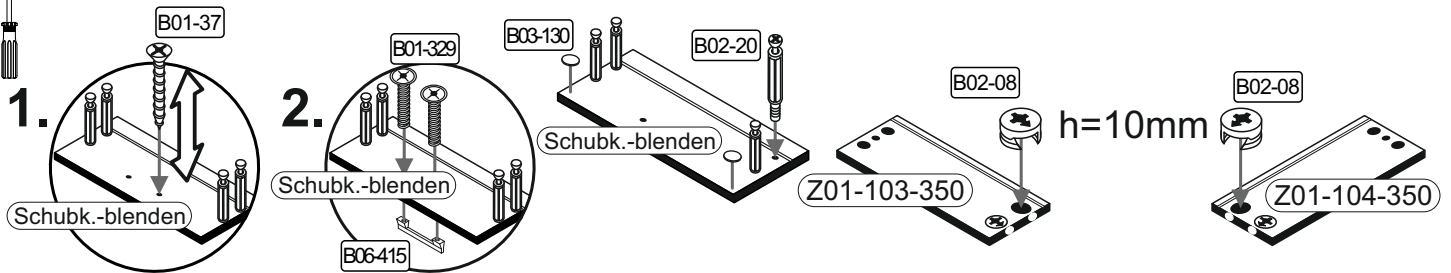

16

B01-70	
4x	3x30

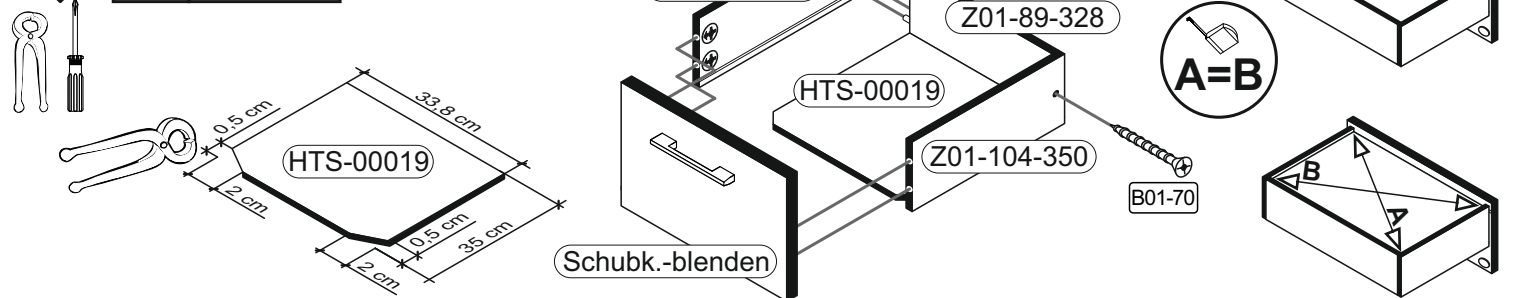

17

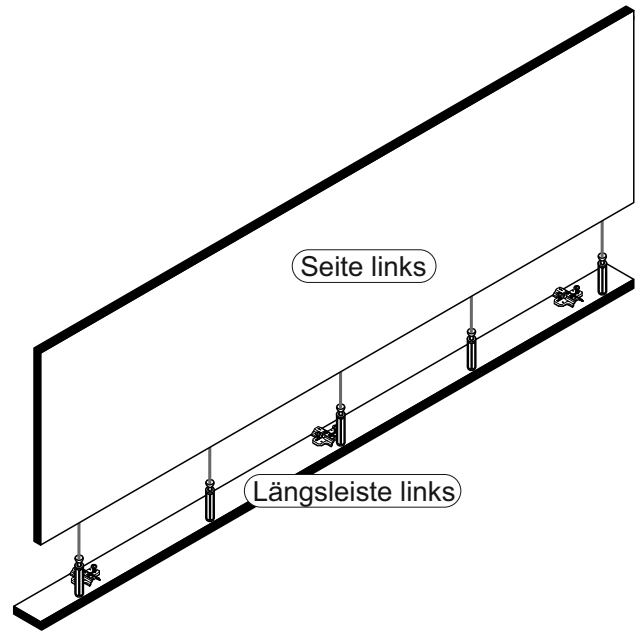
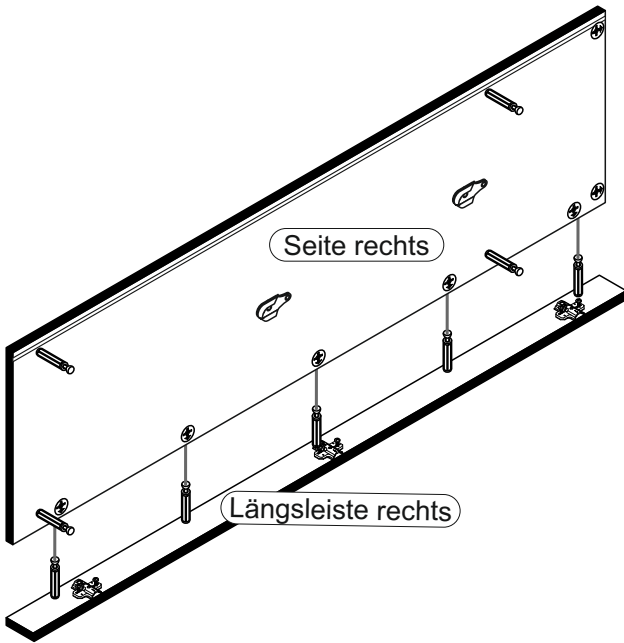

18



B01-10	
4x	6,3x50

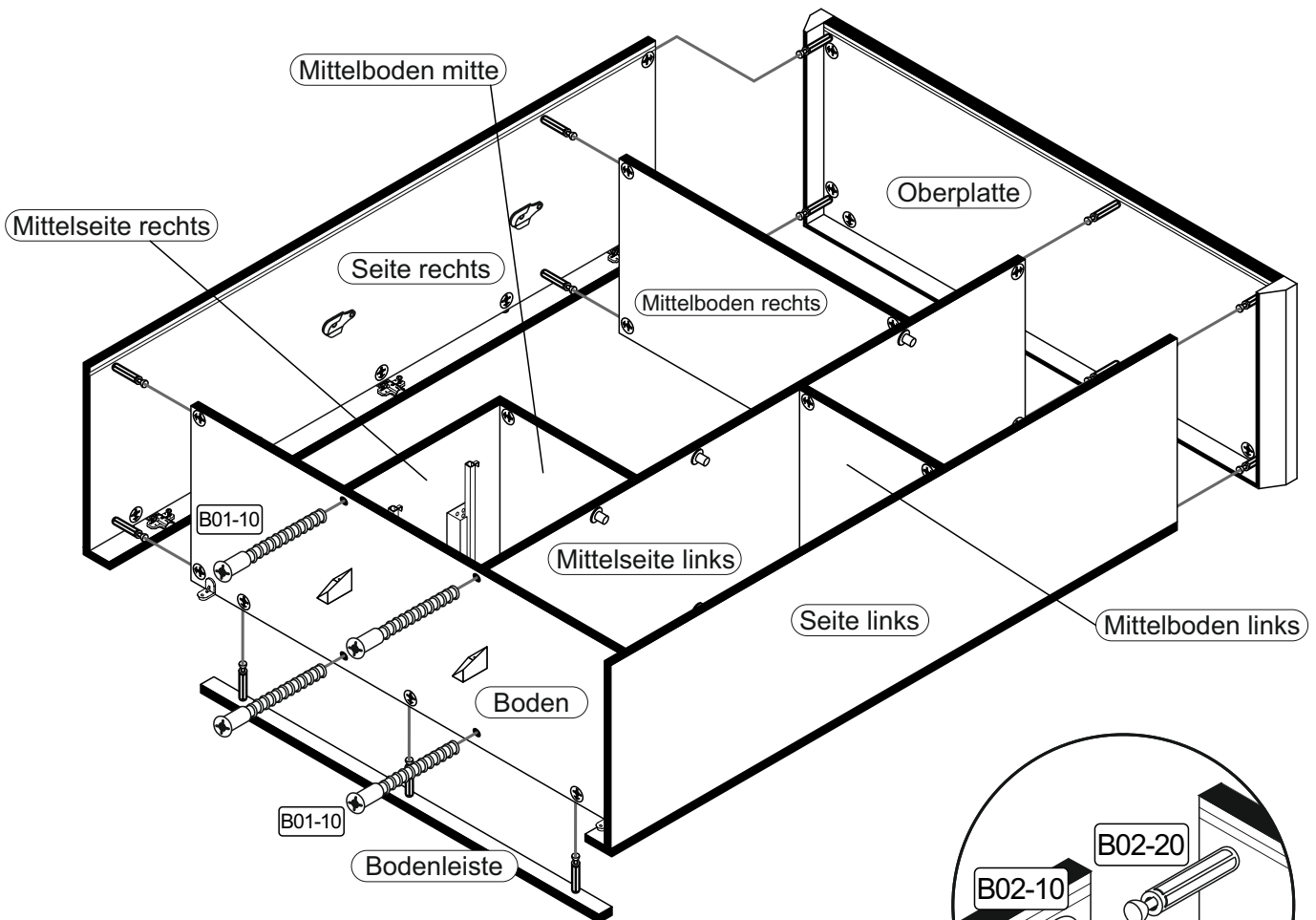

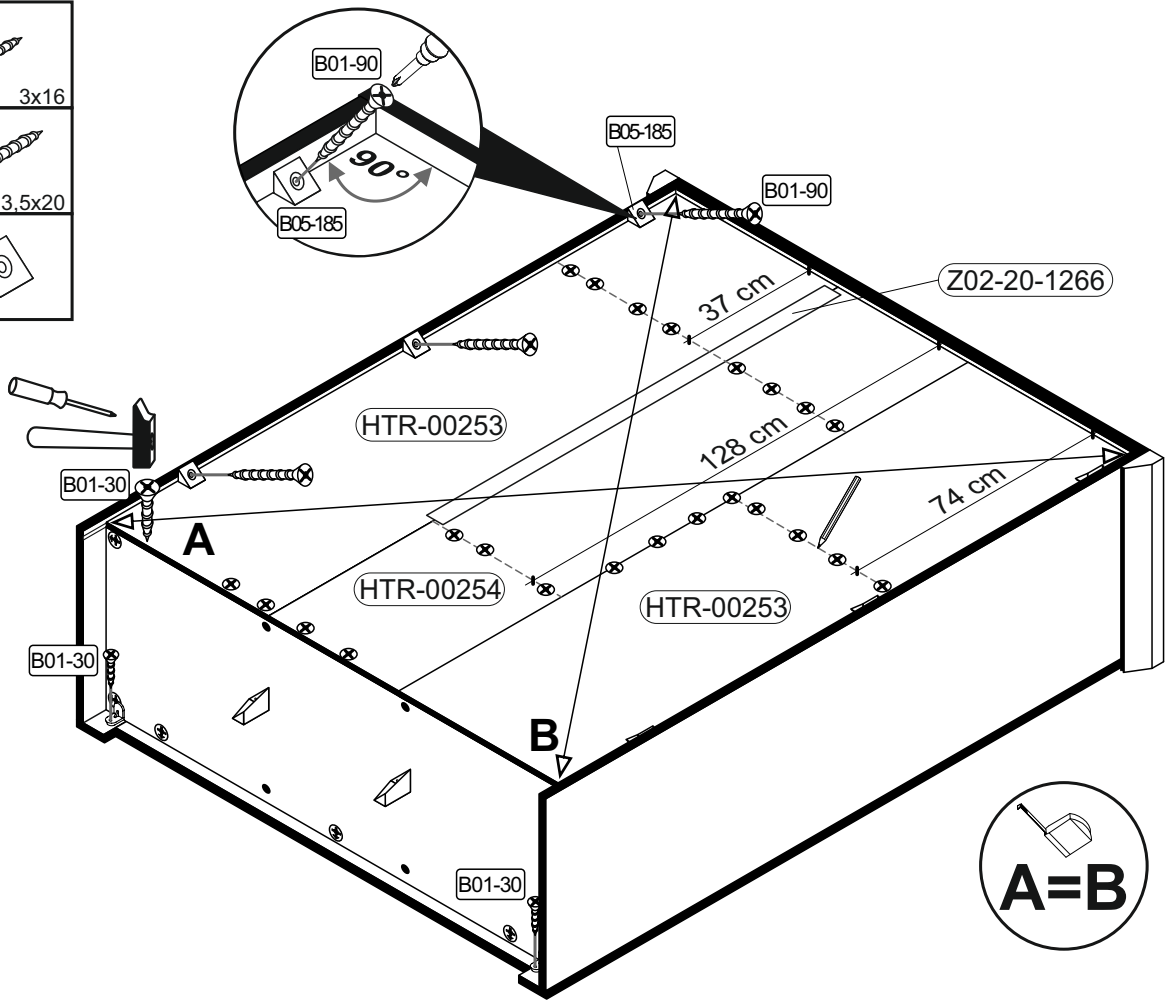

19	B01-30		3x16
	54x		
	B01-90		3,5x20
	6x		
	B05-185		
	6x		

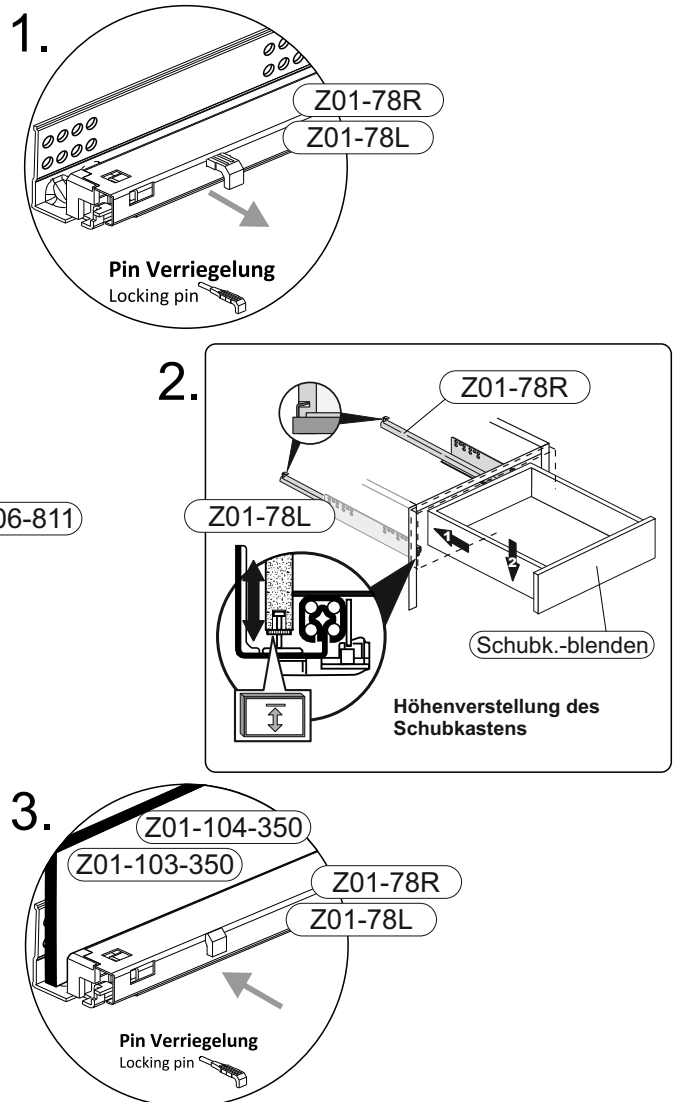
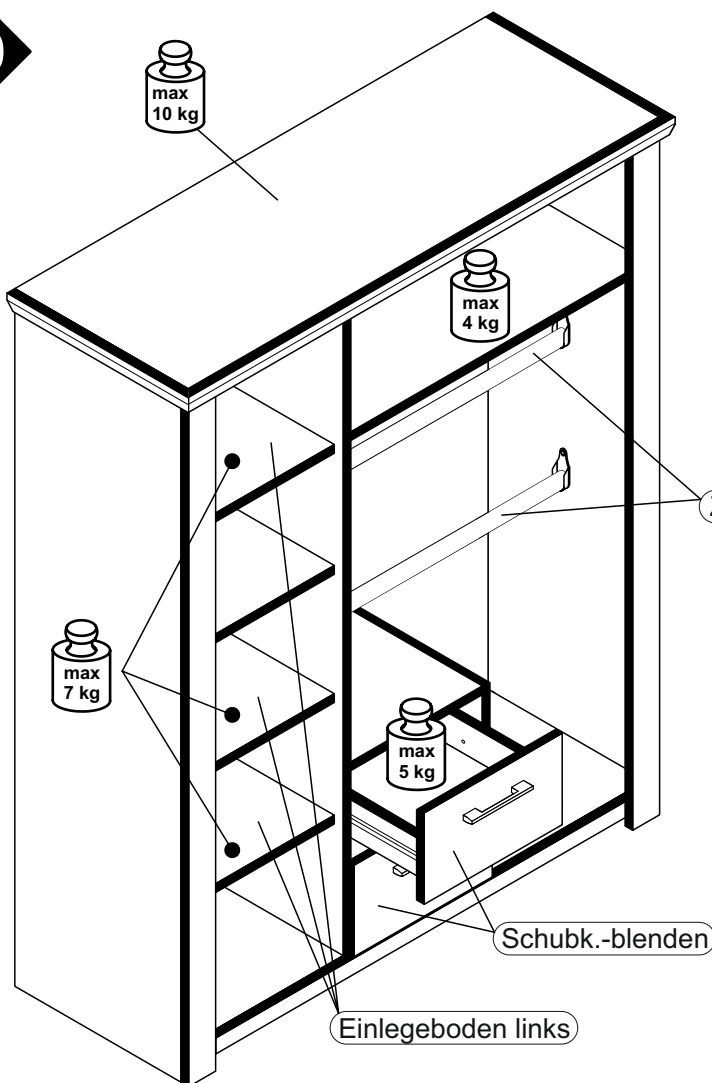

20



21

B03-07		B03-130	
3x		6x	



▶ SCAN ME

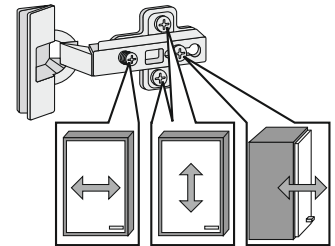
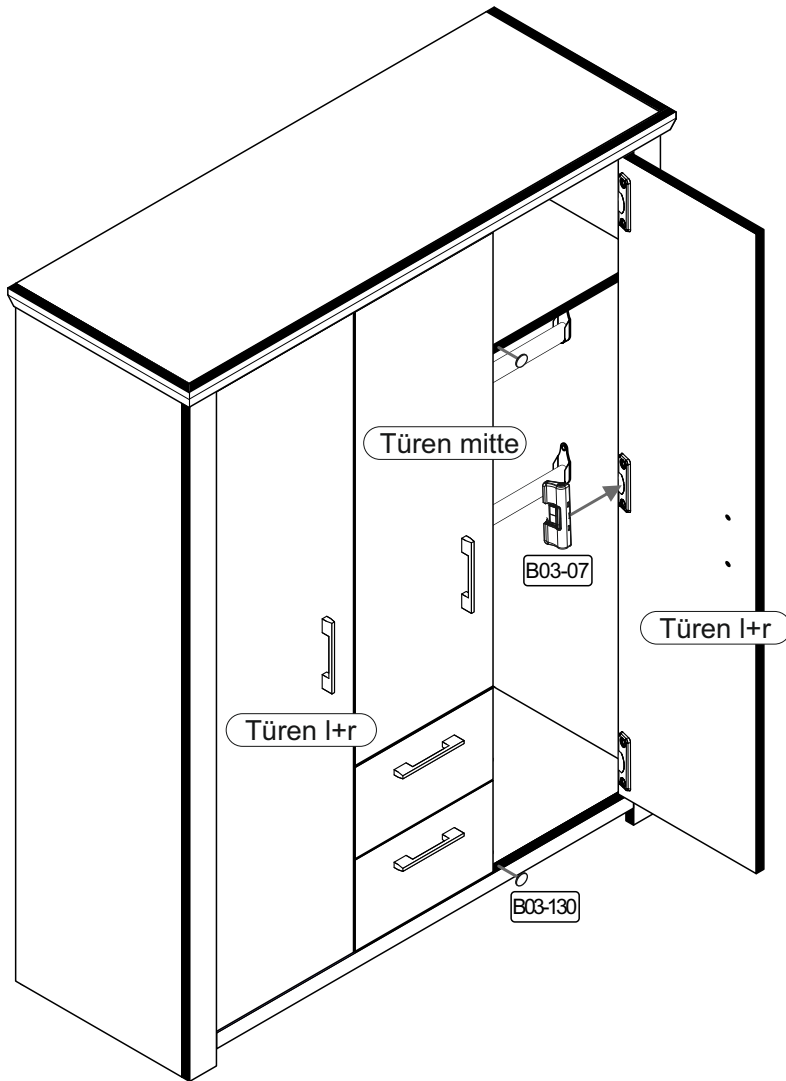
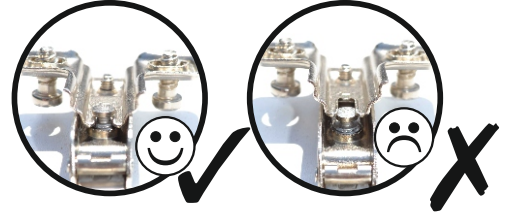

Türen einstellen (Scharniere justieren)
Adjusting the doors (adjusting the hinges)
Régler les portes (ajuster les charnières)
Sistemare le porte (regolare le cerniere)
Deuren instellen (scharnieren afstellen)
Nastawić drzwi (wyregulować zawiasy)
Vyrovnejte dvířka (seřid'te závěsy)
Nastavenie dverí (nastavenie závesov)
Állítsa be az ajtókat (állítsa be a zsanérokot)
Reglare uși (ajustare balamale)
Kapıların ayarlanması (mentşelerin seviye ayarı)
Регулировка дверей (регулировка шарнира)

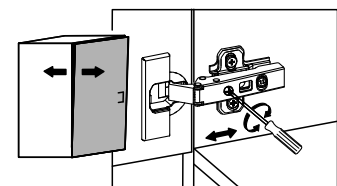
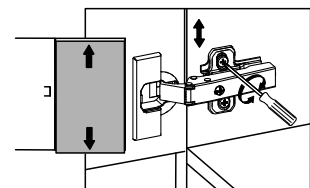
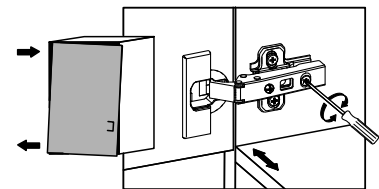

Montage der Tüрдämpfung

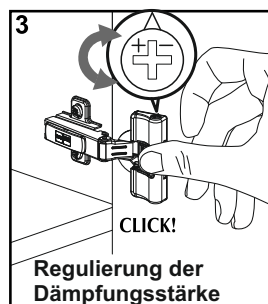
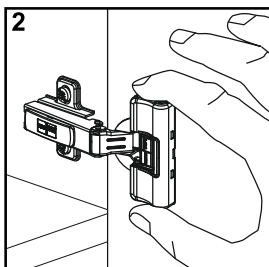
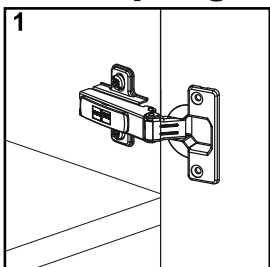

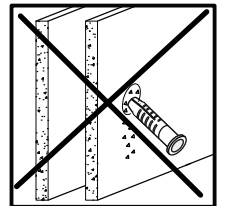
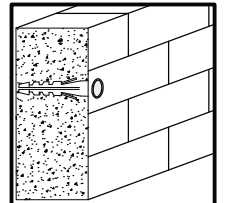
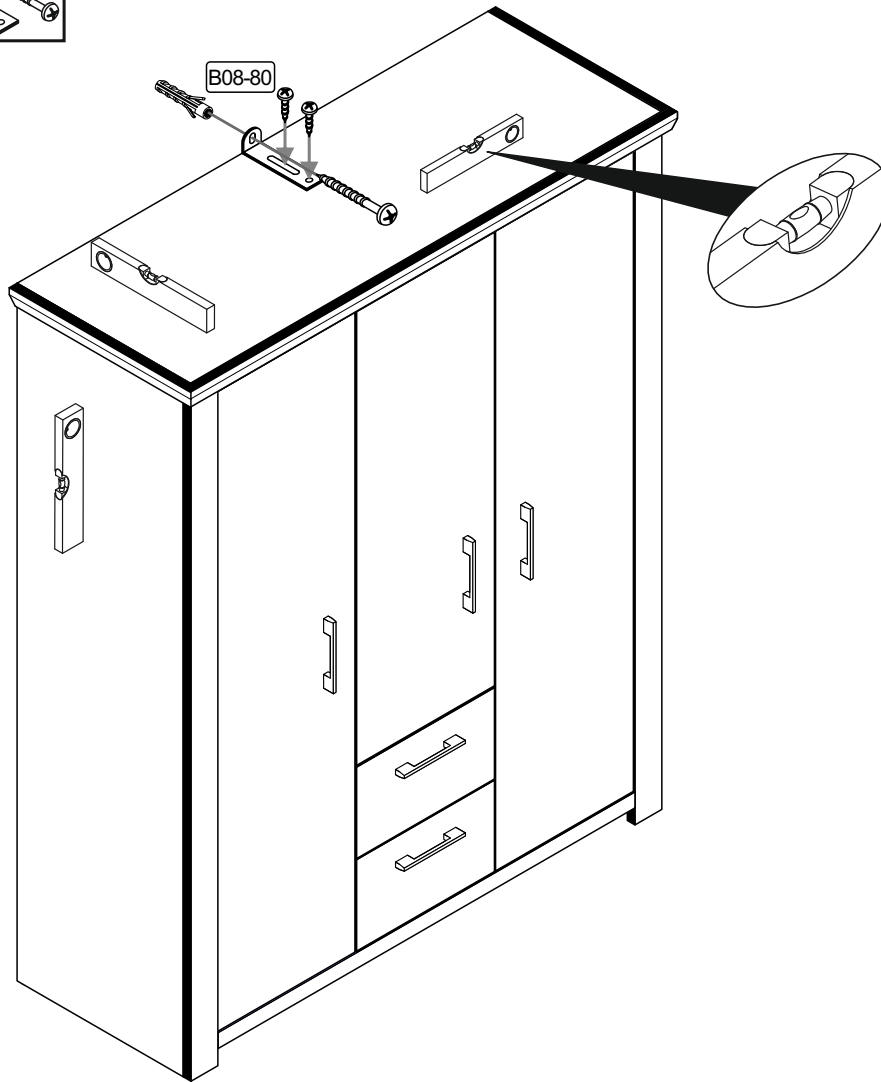
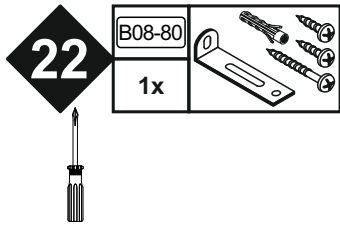

Achtung • Attention • Attenzione • Opgelet • Uwaga • Pozor • Figyelem • Atenție • Dikkat • Внимание	
(D)	Wandbefestigung dient als Kippschutz - unbedingt anbringen! Bei einigen Wandtypen kann ein Spezialdübel erforderlich sein!
(GB)	The wall fastening serves to prevent tipping - be absolutely sure to mount it! For certain wall types, a special wall plug may be necessary!
(FR)	La fixation murale sert de protection contre le basculement – à installer impérativement ! Pour certains types de murs il faut des chevilles spéciales !
(TR)	Duvardaki sabitleme, devrilmeye karşı bir emniyet tedbiridir ve mutlaka monte edilmelidir! Bazı duvar tiplerinde bunun için özel bir dübel gerekli olabilir!
(IT)	Il fissaggio alla parete serve da protezione anti-ribaltamento – attaccarla assolutamente! Per alcune strutture di parete può essere necessario un tassello speciale!
(NL)	Bevestiging aan de muur dient als kantelbescherming – zeker en vast bevestigen! Bij enkele muurtypes is een speciale plug misschien vereist!
(RU)	Обязательно установите крепление на стене во избежание опрокидывания! Для некоторых типов стен может потребоваться специальный дюбель!
(CZ)	Montáž na stěnu slouží jako ochrana proti převrnutí – bezpodmínečně umístěte! U některých typů stěn může být zapotřebí speciální hmoždinka!
(HU)	A terméket a falhoz kel rögzíteni, különben az felborulhat! Egyes faltípusoknál speciális tiplit kell használni!
(RO)	Sistemul de fixare la perete servește ca protecție la răsturnare - de montat obligatoriu! Pentru unele tipuri de pereți este posibil să fie necesar un diblu special!
(PL)	Mocowanie do ściany jest jednocześnie zabezpieczeniem przed przewróceniem – koniecznie zamontować! Do niektórych rodzajów ścian koniecznie zastosować specjalne kołki mocujące.
(SK)	Upevnenie na stenu slúži ako ochrana proti prevráteniu – bezpodmienečne použite! Pre niektoré druhy stien môže byť potrebná špeciálna hmoždinka!