

**FOB\_FU\_0588**

**Metallfüße**

DE Fuß / Position

EN Foot / Position

NL Poot / Positie

IT Piedi / Posizione





RU Ноги / Позиция

FR Pied / Position

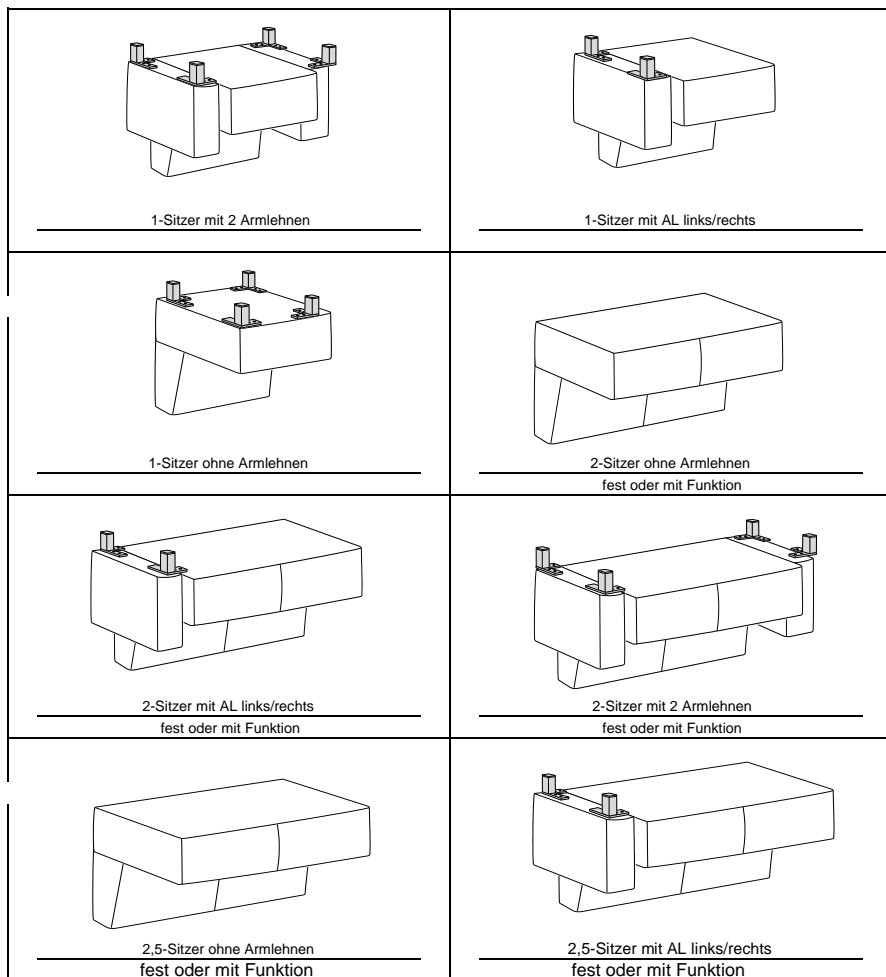
ES Pie / Posición

TR Ayak / Pozisyon



A Höhe 12cm/15 cm	B Höhe 12cm/15 cm	C Höhe 12cm/15 cm	D Höhe 12cm/15 cm	E Höhe	F	<b>Modellnummer</b> 1363/1364/1365/1366
						<b>Stand</b> 01.02.2021
<b>Metallfuß</b>	<b>Metallfuß</b>	<b>Metallfuß</b>	<b>Stützfuß</b>	<b>Stützfuß</b>		<b>Revision</b> 03
Kundenseitig	Kundenseitig	Kundenseitig	Kundenseitig	Werkseitig		<b>Verfasser</b> RSZ

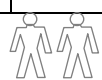
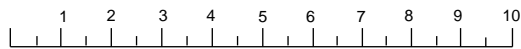

**FOB\_FU\_0588**

**Metallfüße**

DE Fuß / Position

EN Foot / Position

NL Poot / Positie

IT Piedi / Posizione

RU Ноги / Позиция

FR Pied / Position

ES Pie / Posición

TR Ayak / Pozisyon

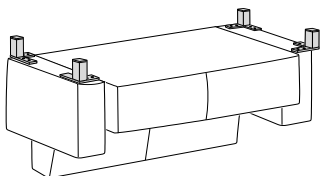

2,5-Sitzer mit 2 Armlehnen  
fest oder mit Funktion

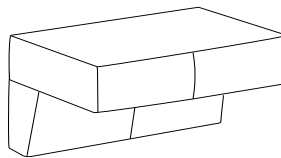

3-Sitzer ohne Armlehnen fest

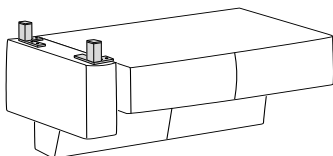

3-Sitzer mit AL links/rechts fest

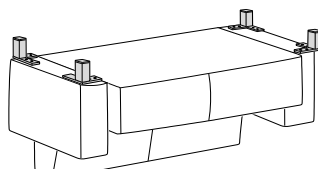

3-Sitzer mit 2 Armlehnen fest

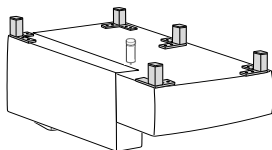

Eckelement + 1-Sitzer mit Abschlussteil li./re.

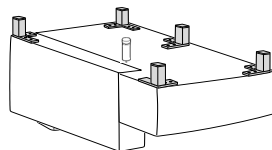

Eckelement + 1-Sitzer mit Abschlussteil li./re.  
Stauraum

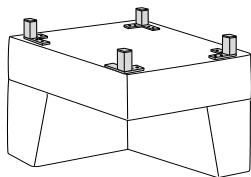

Spitzeckteil klein

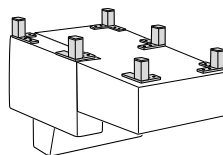

Longchair/Longchair maxi mit Armlehne li./re.  
Longchair/Longchair maxi mit Armlehne li./re. Schlaffunktion

A	Höhe 12cm/15 cm	B	Höhe 12cm/15 cm	C	Höhe 12cm/15 cm	D	Höhe 12cm/15 cm	E	Höhe	F	Höhe	Modellnummer 1363/1364/1365/1366
												Stand 01.02.2021
Metallfuß		Metallfuß		Metallfuß		Stützfuß		Stützfuß				Revision 03
Kundenseitig		Kundenseitig		Kundenseitig		Kundenseitig		Werkseitig				Verfasser RSZ

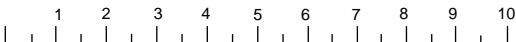

**FOB\_FU\_0588**

**Metallfüße**

DE Fuß / Position

EN Foot / Position

NL Poot / Positie

IT Piedi / Posizione

RU Ноги / Позиция

FR Pied / Position

ES Pie / Posición

TR Ayak / Pozisyon

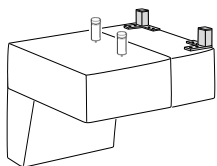

1-Sitzer m. Abschlussteil li./re.  
Stauraum

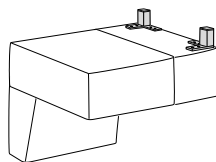

1-Sitzer m. Abschlussteil li./re.

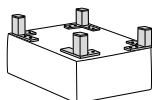

Hocker

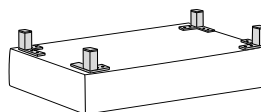

Hockerbank

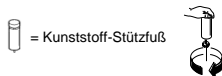

= Kunststoff-Stützfuß

Bei AT A, B, C, F alle

bei SH 42cm  
= Metallfuß 728 Chrom glänzend  
= Metallfuß 191 schwarz matt

bei SH 45cm  
= Metallfuß 729 Chrom glänzend  
= Metallfuß 365 schwarz matt

Bei AT D und E nur

bei SH 42cm  
= Metallfuß 001 / 522 / 569 / 636 Aluminium  
= Metallfuß 869 schwarz matt

bei SH 45cm  
= Metallfuß 534 / 637 Aluminium  
= Metallfuß 870 schwarz matt

Bei AT A, B, C, F alle

bei SH 42cm  
= Metallfuß 506 Chrom glänzend  
= Metallfuß 865 schwarz matt

bei SH 45cm  
= Metallfuß 698 Chrom glänzend  
= Metallfuß 866 schwarz matt

A	Höhe 12cm/15 cm	B	Höhe 12cm/15 cm	C	Höhe 12cm/15 cm	D	Höhe 12cm/15 cm	E	Höhe	F	Höhe	Modellnummer 1363/1364/1365/1366
								B				Stand 01.02.2021
Metallfuß		Metallfuß		Metallfuß		Stützfuß		Stützfuß				Revision 0003
Kundenseitig		Kundenseitig		Kundenseitig		Kundenseitig		Werkseitig				Verfasser RSZ

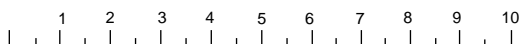

**FOB\_FU\_0588**

**Holzfüße**

DE Fuß / Position

EN Foot / Position

NL Poot / Positie

IT Piedi / Posizione

RU Ноги / Позиция

FR Pied / Position

ES Pie / Posición

TR Ayak / Pozisyon

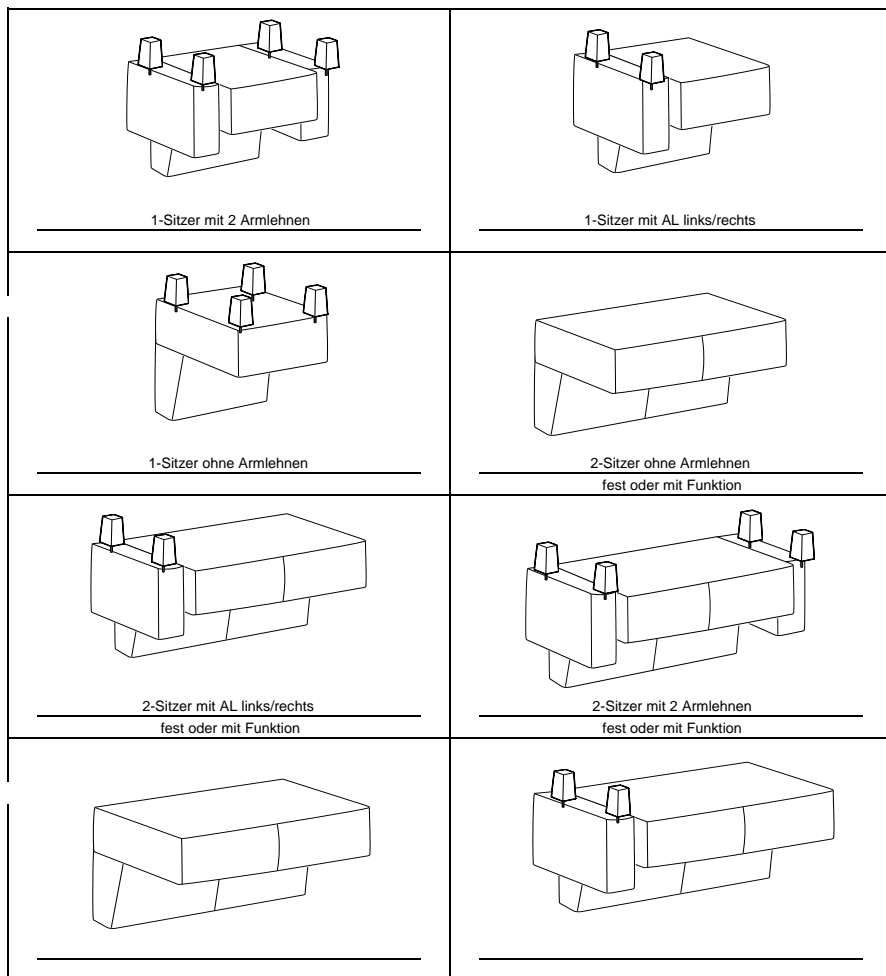

A	Höhe 12cm/15 cm	B	Höhe 12cm/15 cm	C	Höhe	D	E	F	Modellnummer 1363/1364/1365/1366
									Stand 01.02.2021
<b>Holzfuß</b>		<b>Stützfuß</b>		<b>Stützfuß</b>					Revision 03
Kundenseitig		Kundenseitig		Werkseitig					Verfasser RSZ

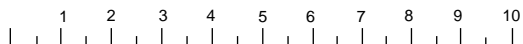

**FOB\_FU\_0588**

**Holzfüße**

DE Fuß / Position

EN Foot / Position

NL Poot / Positie

IT Piedi / Posizione

RU Ноги / Позиция

FR Pied / Position

ES Pie / Posición

TR Ayak / Pozisyon

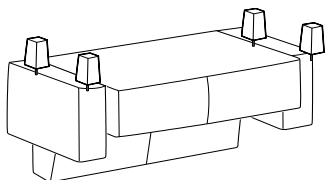

2,5-Sitzer mit 2 Armlehnen  
fest oder mit Funktion

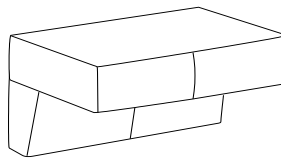

3-Sitzer ohne Armlehnen fest

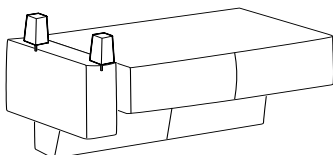

3-Sitzer mit AL links/rechts fest

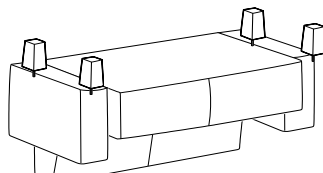

3-Sitzer mit 2 Armlehnen fest

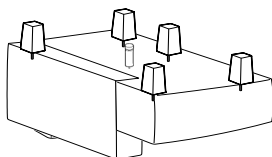

Eckelement + 1-Sitzer mit Abschlussteil li./re.

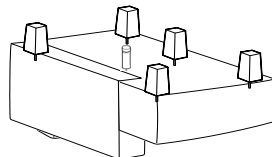

Eckelement + 1-Sitzer mit Abschlussteil li./re.  
Stauraum

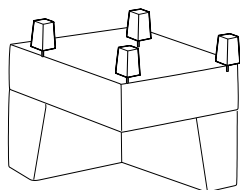

Spitzeckteil klein

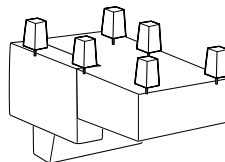

Longchair/Longchair maxi mit Armlehne li./re.  
Longchair/Longchair maxi mit Armlehne li./re. Schlaffunktion

<b>A</b> Höhe 12cm/15 cm	<b>B</b> Höhe 12cm/15 cm	<b>C</b> Höhe	<b>D</b> 12cm	<b>E</b>	<b>F</b>	<b>Modellnummer</b> 1363/1364/1365/1366
						<b>Stand</b> 01.02.2021
<b>Holzfuß</b>	<b>Stützfuß</b>	<b>Stützfuß</b>				<b>Revision</b> 03
Kundenseitig	Kundenseitig	Werkseitig				<b>Verfasser</b> RSZ

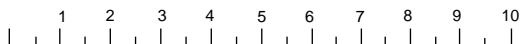

**FOB\_FU\_0588**

**Holzfüße**

DE Fuß / Position

EN Foot / Position

NL Poot / Positie

IT Piedi / Posizione



RU Ноги / Позиция

FR Pied / Position

ES Pie / Posición

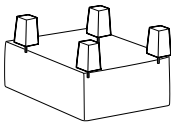
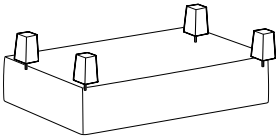
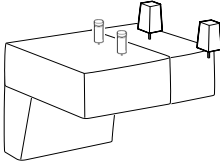
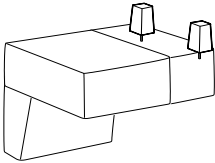
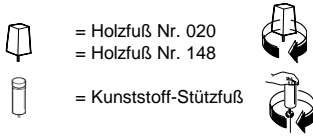
TR Ayak / Pozisyon

 <p style="text-align: center;">Hocker</p>	 <p style="text-align: center;">Hockerbank</p>
 <p style="text-align: center;">1-Sitzer m. Abschlussteil li./re. Stauraum</p>	 <p style="text-align: center;">1-Sitzer m. Abschlussteil li./re.</p>
<p style="text-align: center;">_____</p>	<p style="text-align: center;">_____</p>
 <p style="text-align: center;">_____</p>	<p style="text-align: center;">_____</p>

<p>(A) Höhe 12cm/15 cm</p>	<p>(B) Höhe 12cm/15 cm</p>	<p>(C) Höhe</p>	<p>(D)</p>	<p>(E)</p>	<p>(F)</p>	<p><b>Modellnummer</b> 1363/1364/1365/1366</p>
						<p><b>Stand</b> 29.01.2021</p>
<p><b>Holzfuß</b> Kundenseitig</p>	<p><b>Stützfuß</b> Kundenseitig</p>	<p><b>Stützfuß</b> Werkseitig</p>				<p><b>Revision</b> 03</p>
						<p><b>Verfasser</b> RSZ</p>

