

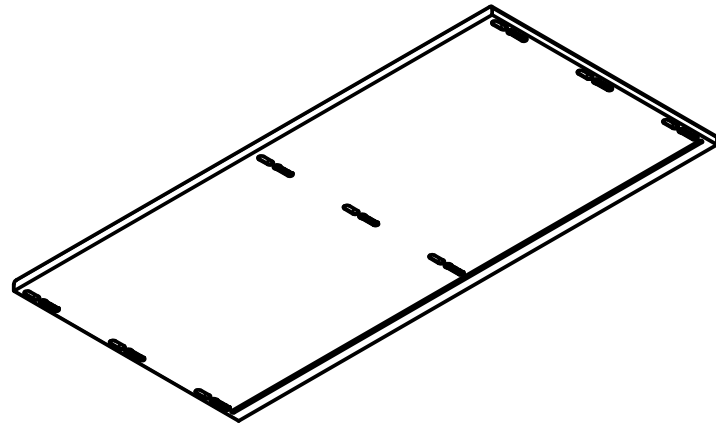

KEEP
byhammel

50006

50006-P1 /6

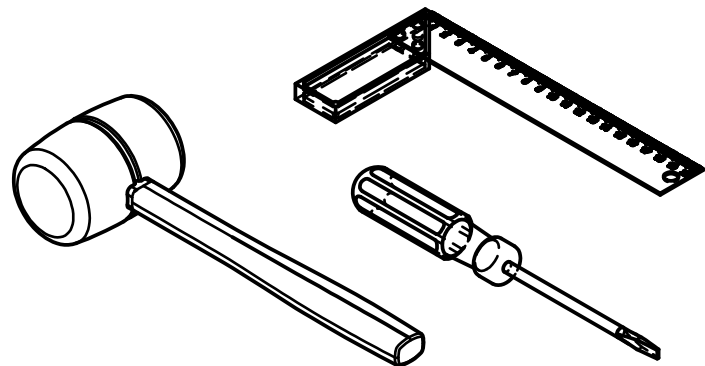
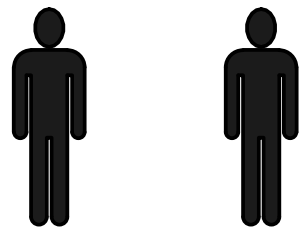
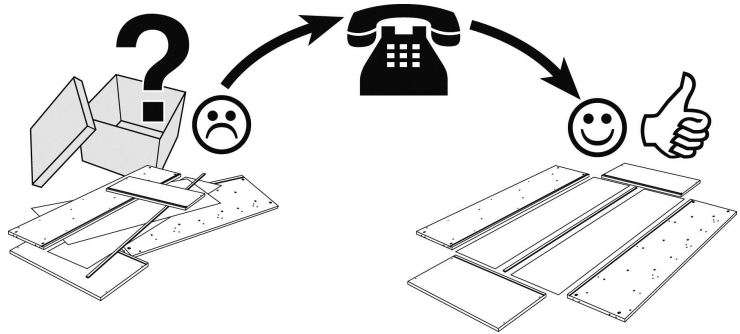
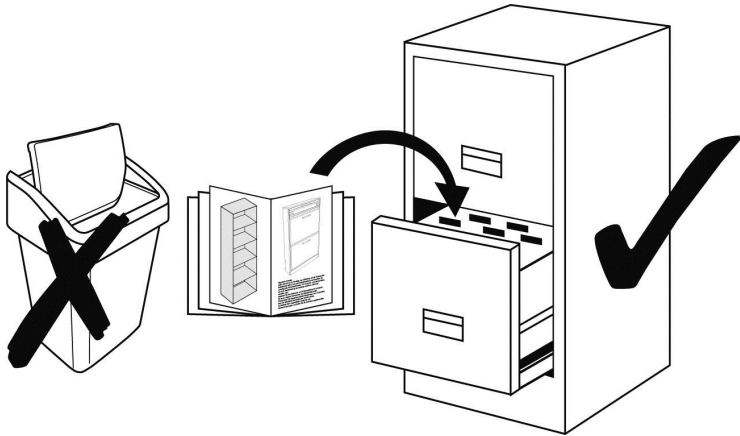

F1 (2010167xx)

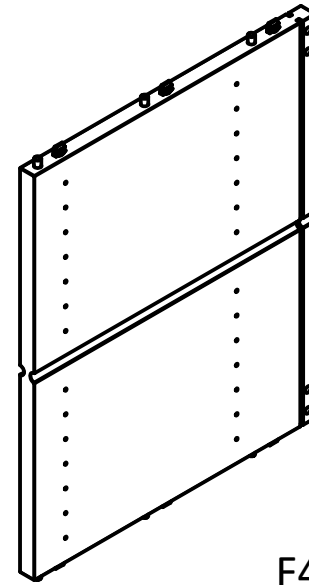

F4 (2072144xx)

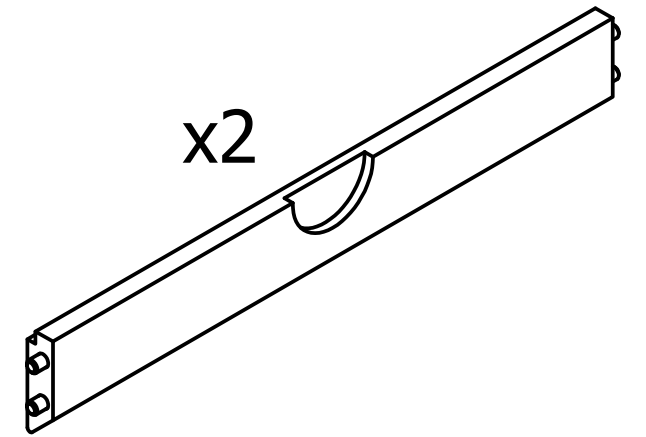

x2

F7 (113112395)

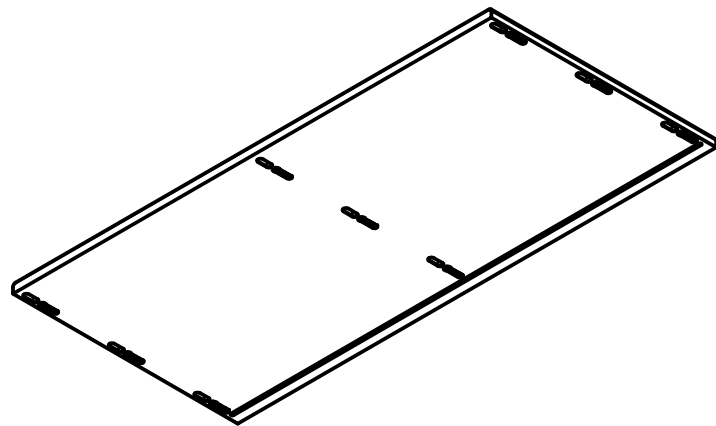

F2 (2010168xx)

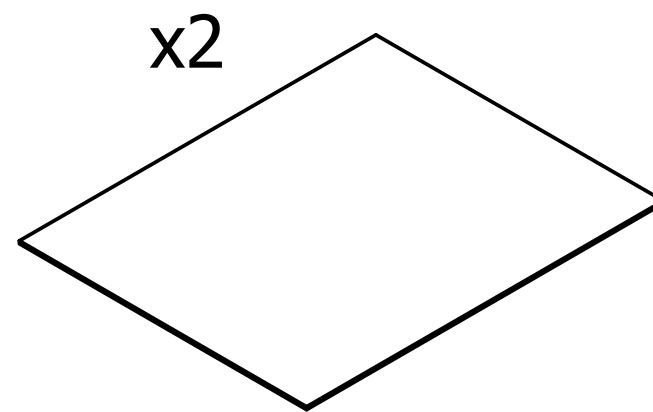

x2

F5 (2051603xx)

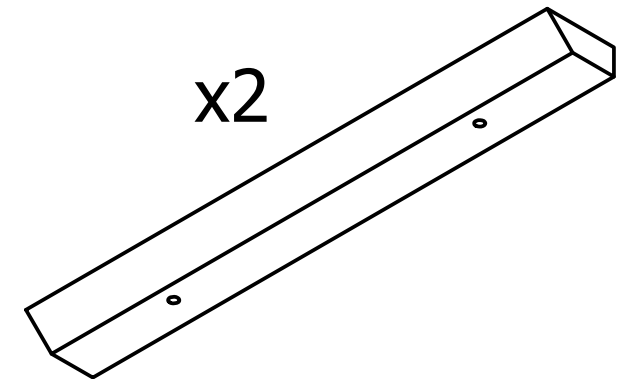

x2

F8 (111290095)

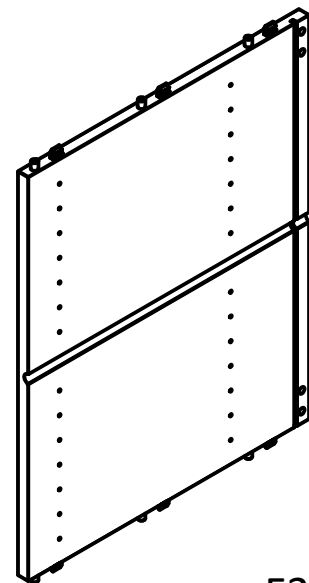

x2

F3 (2036138xx)

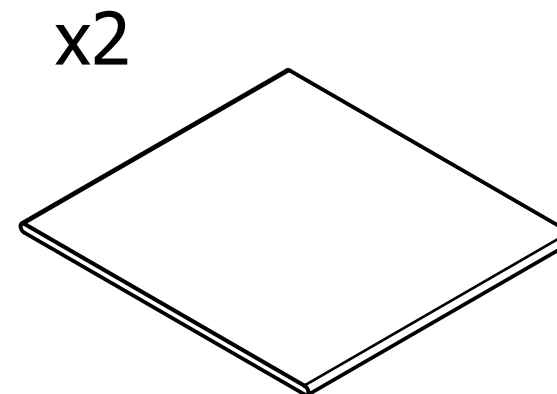

x2

F6 (2134134xx)

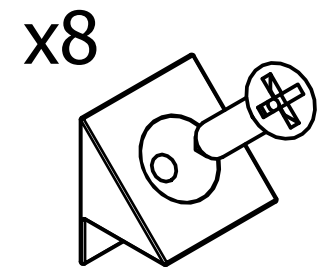

x8

F9 (6201020)

1

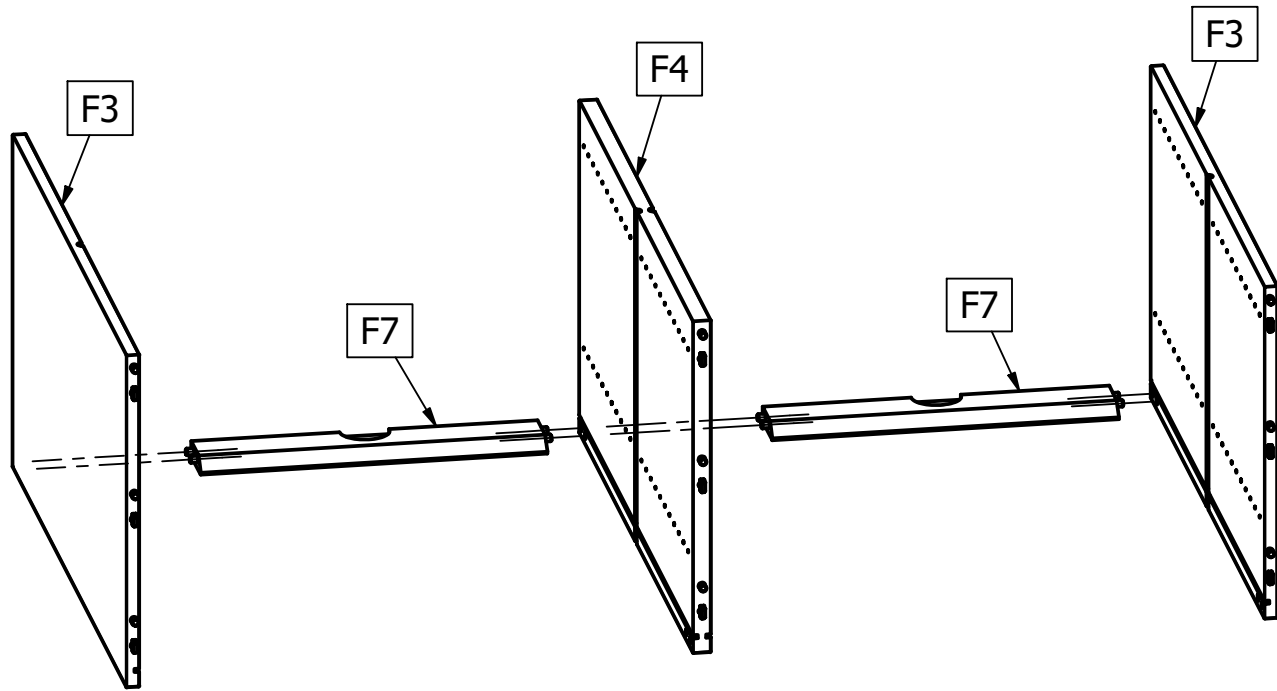

3

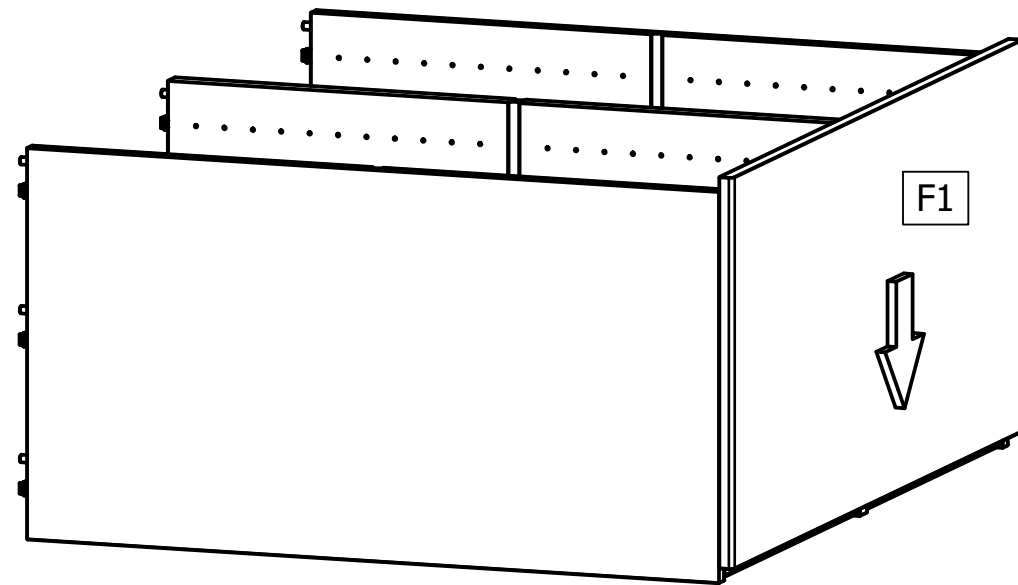

2

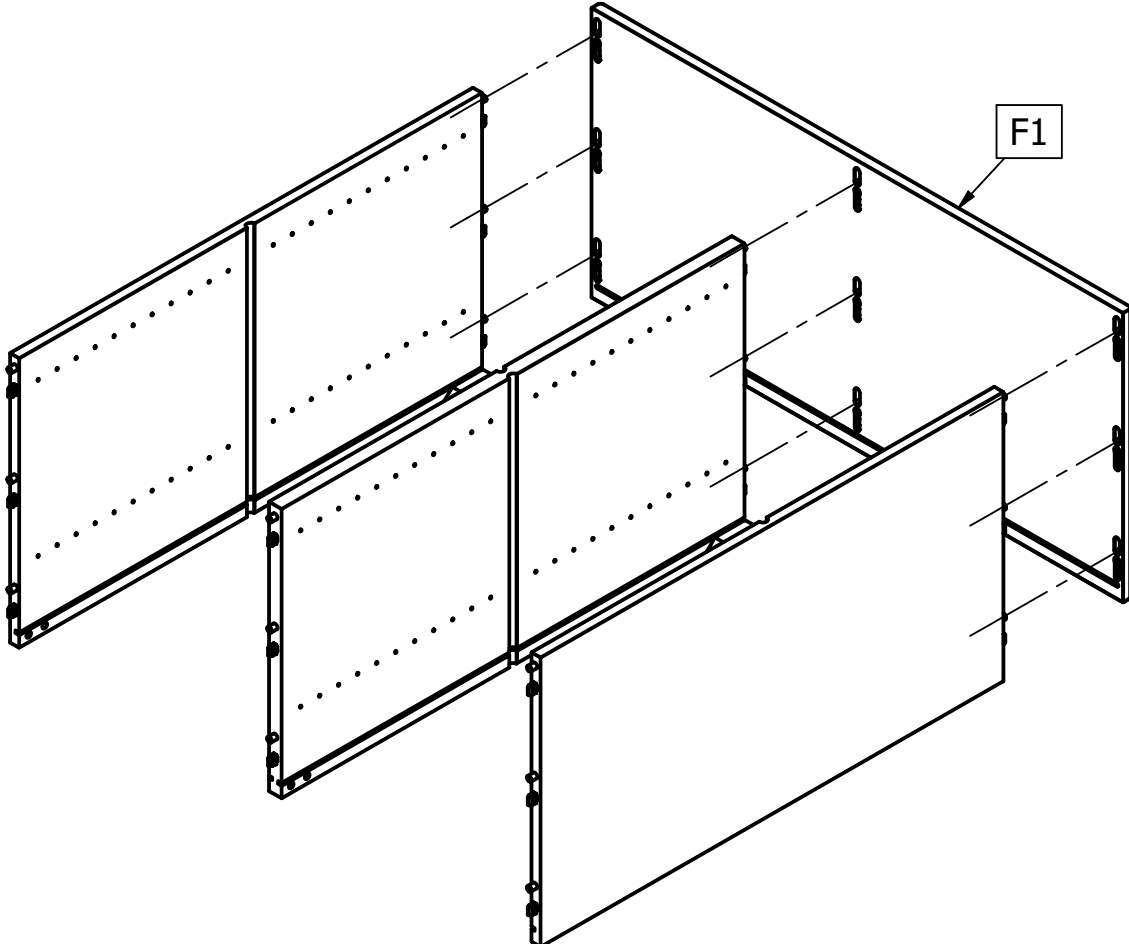

4

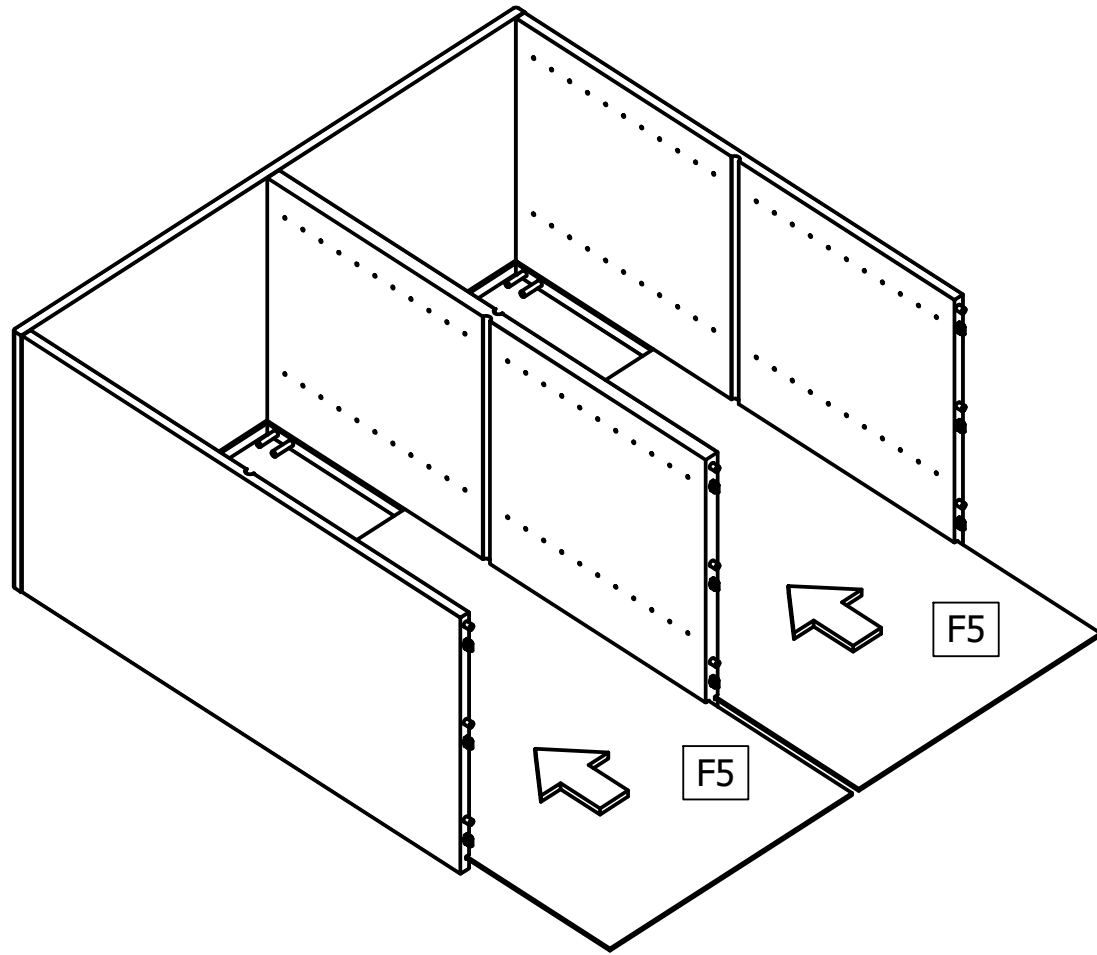

5

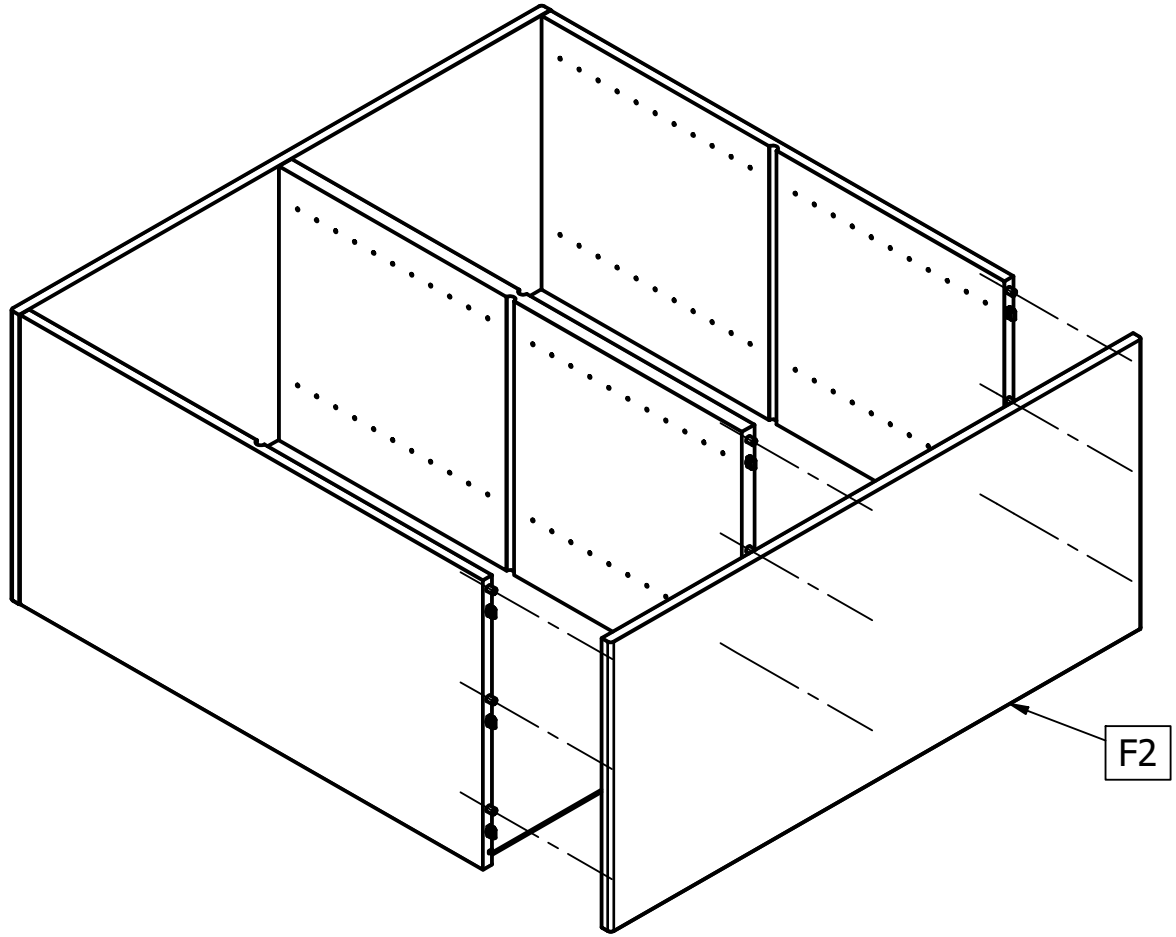

7

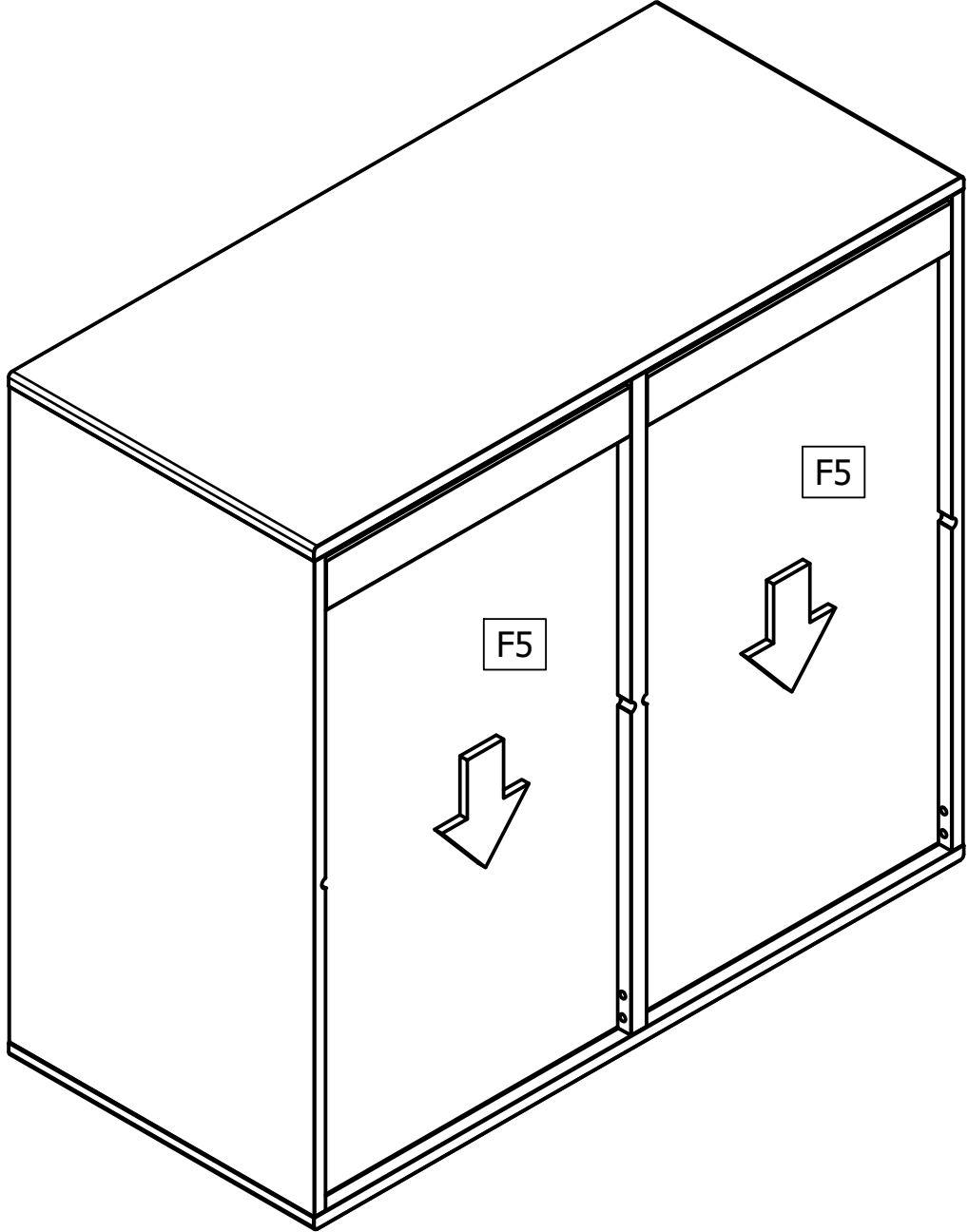

6

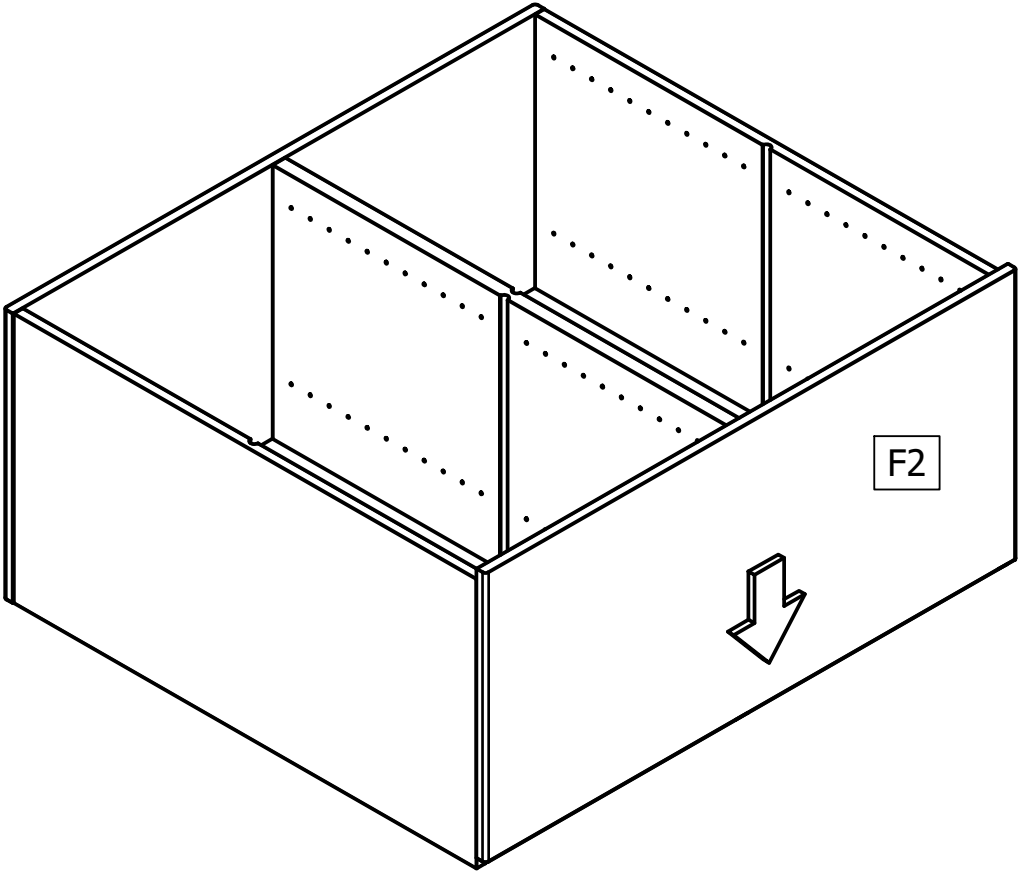

8

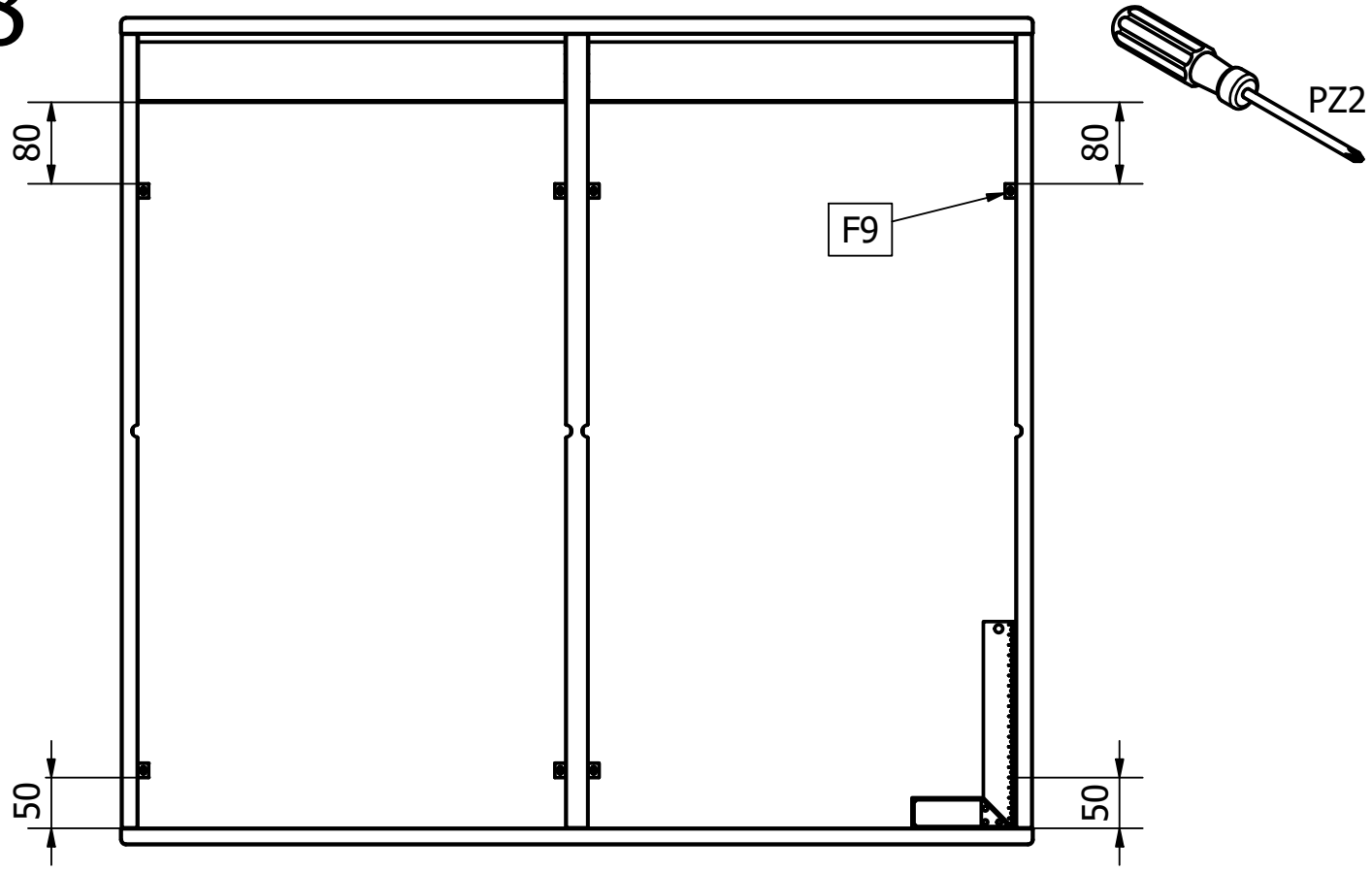

9

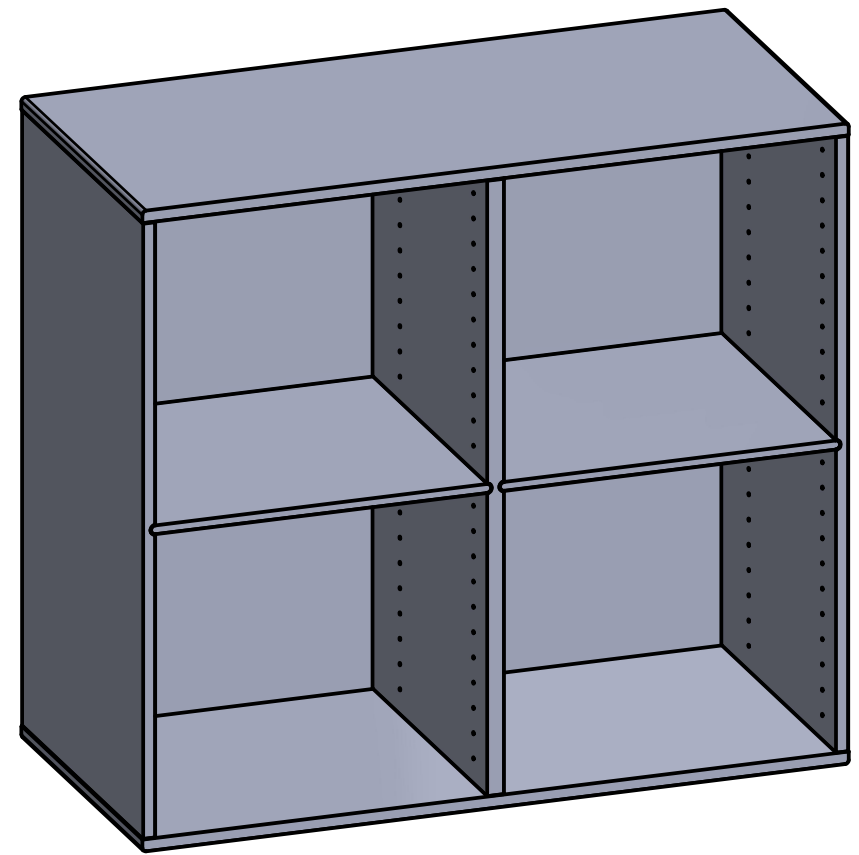
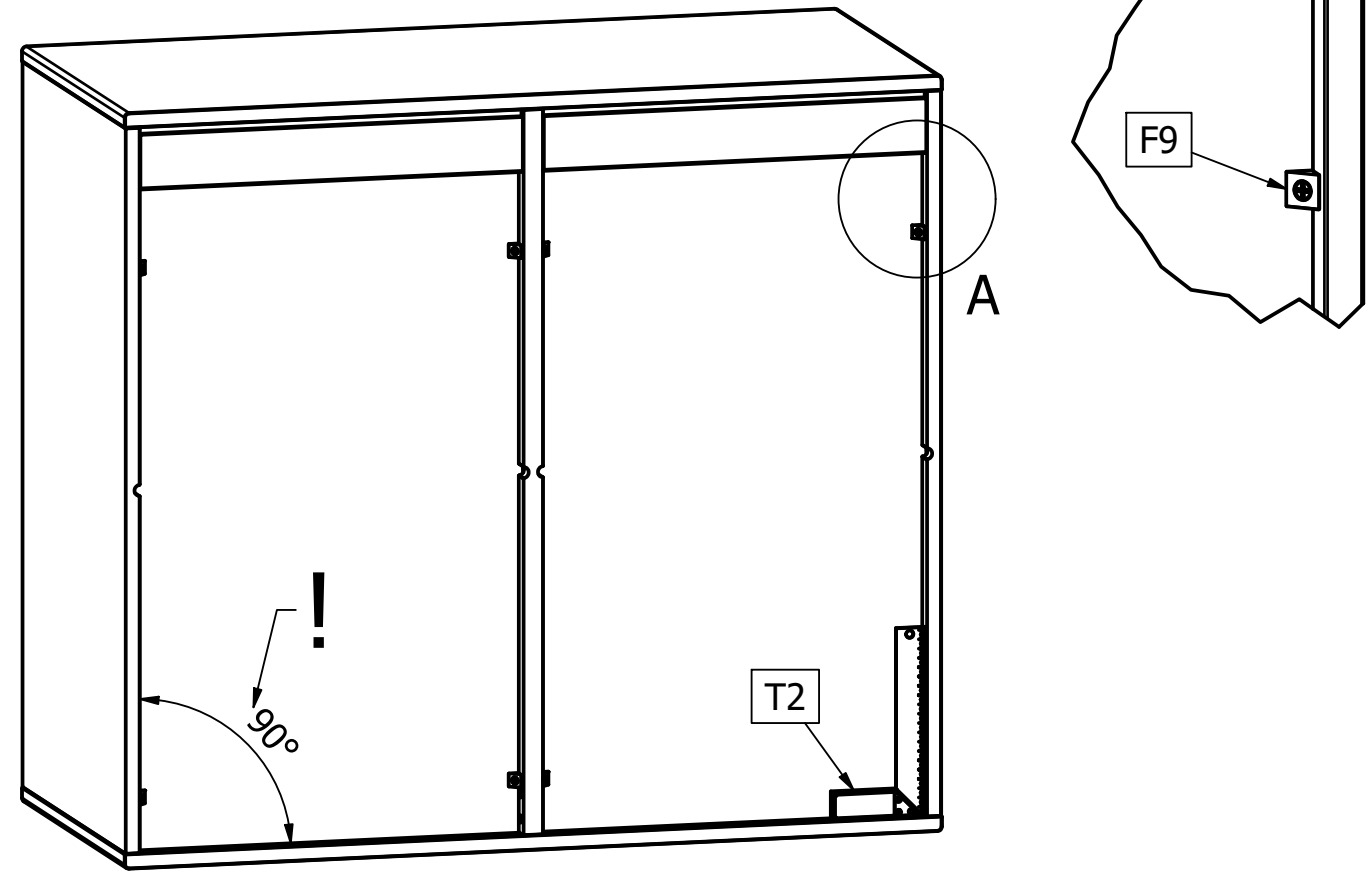
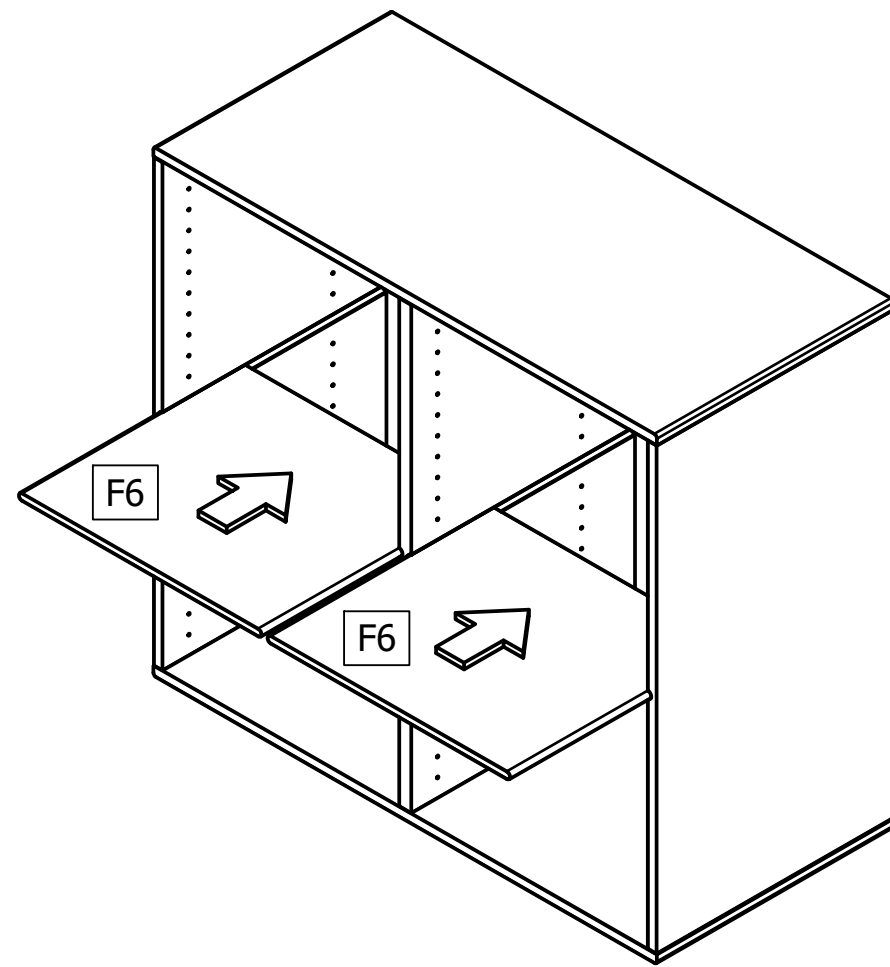

Eksempel:

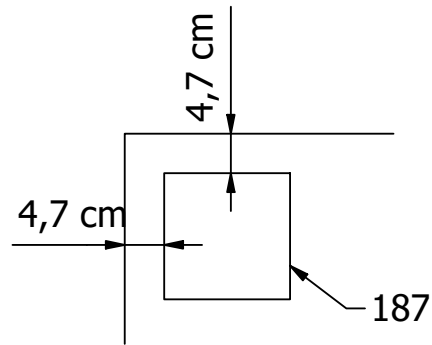
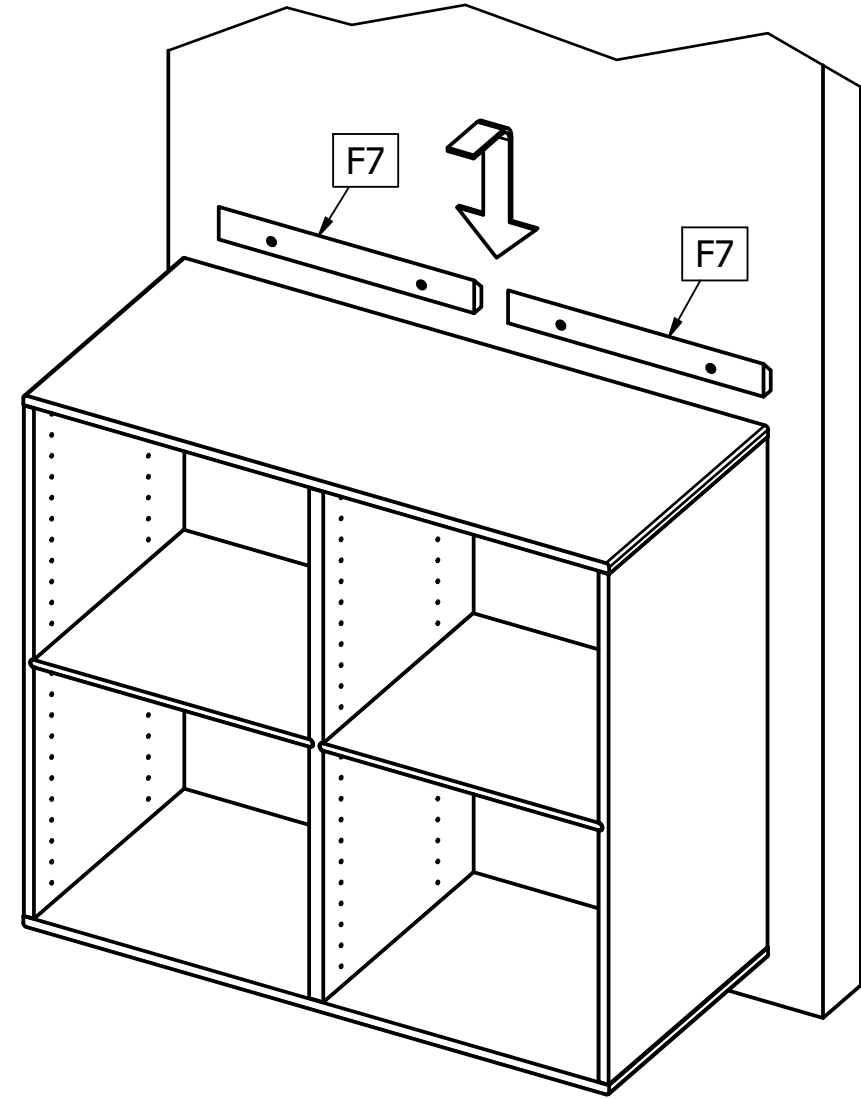
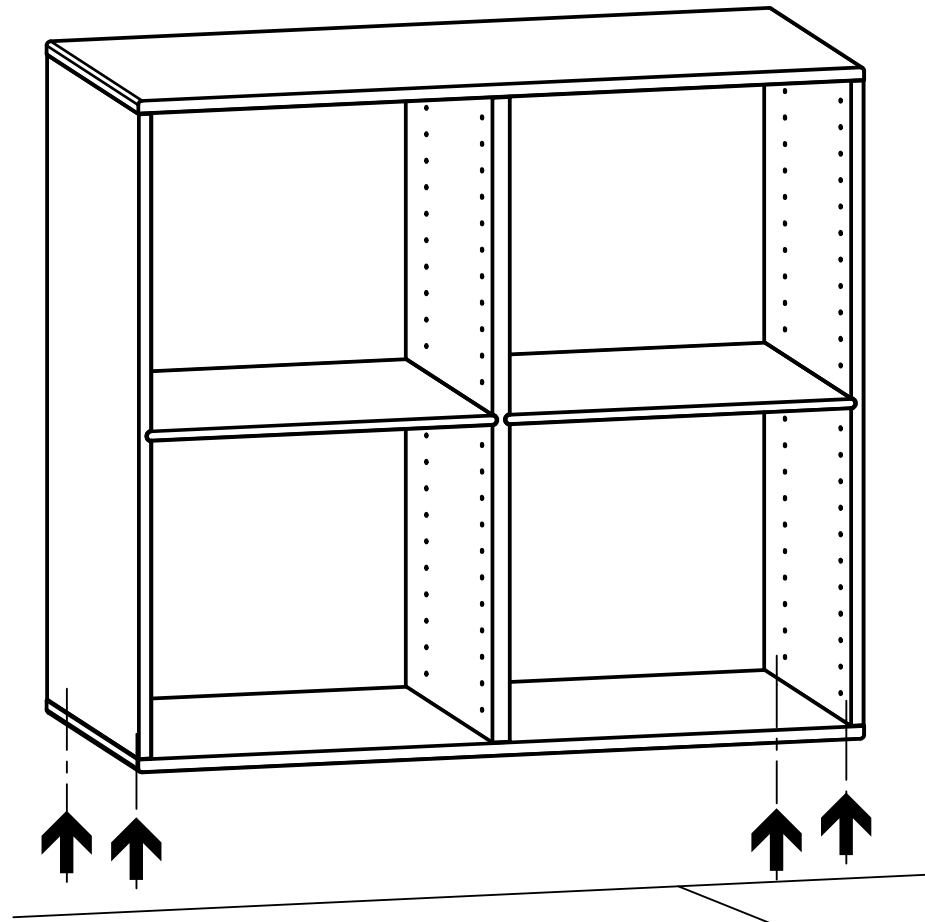

Anbefalet placering af hjul.
 Recommended placement of castors.
 Empfohlene Platzierung der Roller.
 Placement recommandé des roulettes.
 Recommenderad placering av hjul.

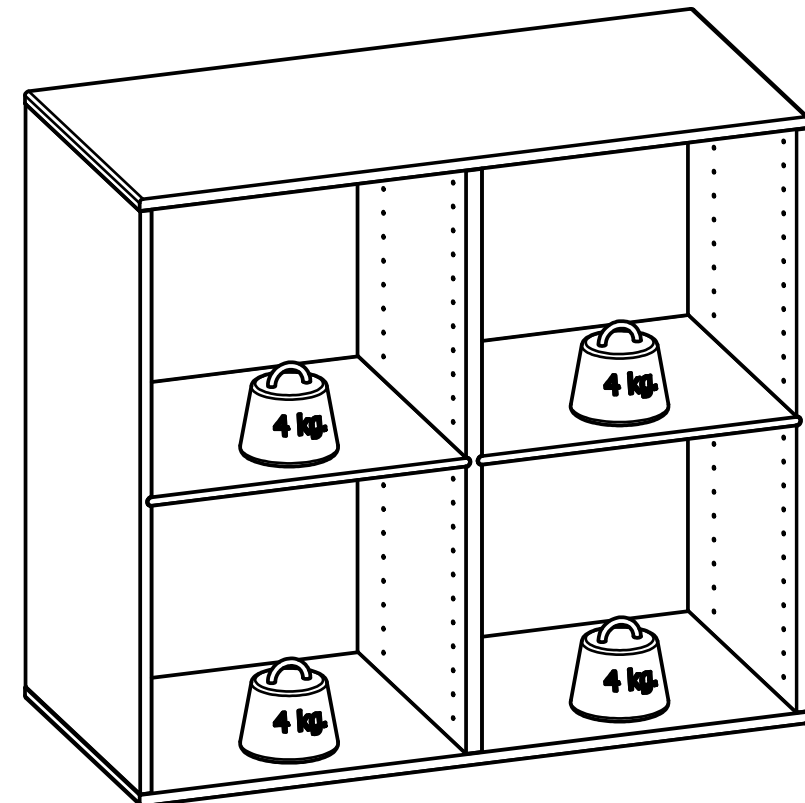



KEEP

byhammel

50006

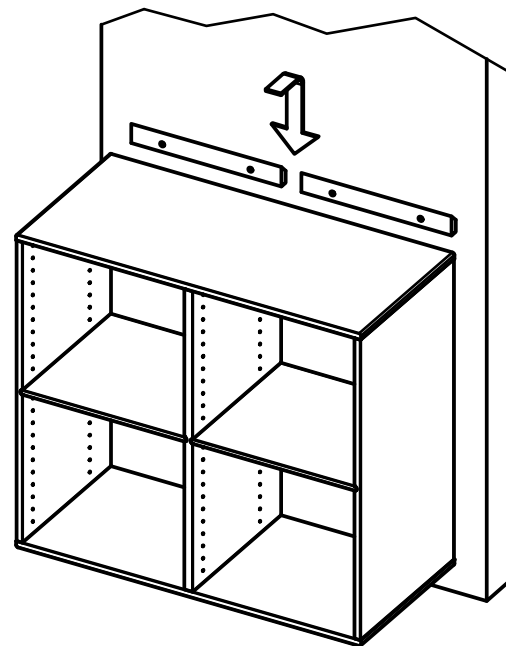
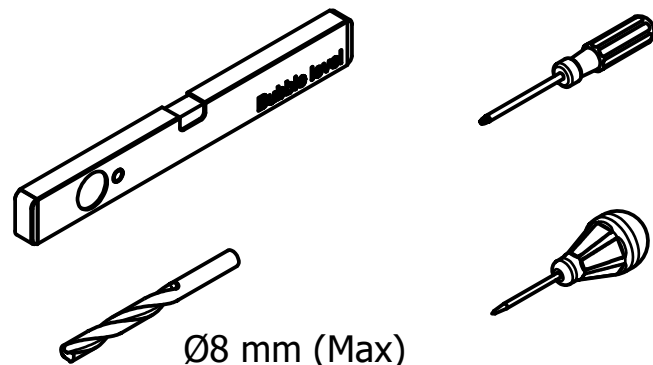
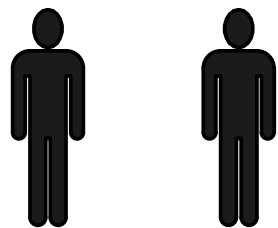
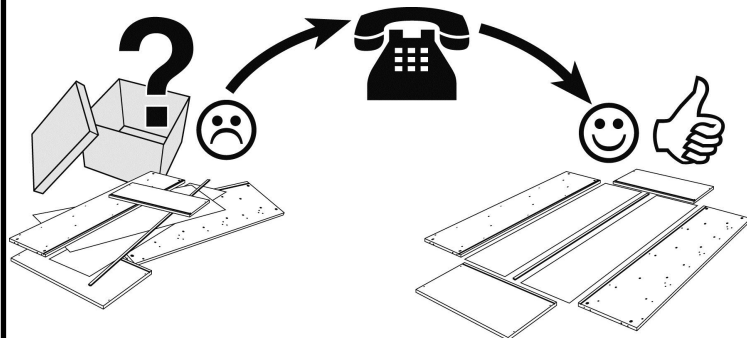
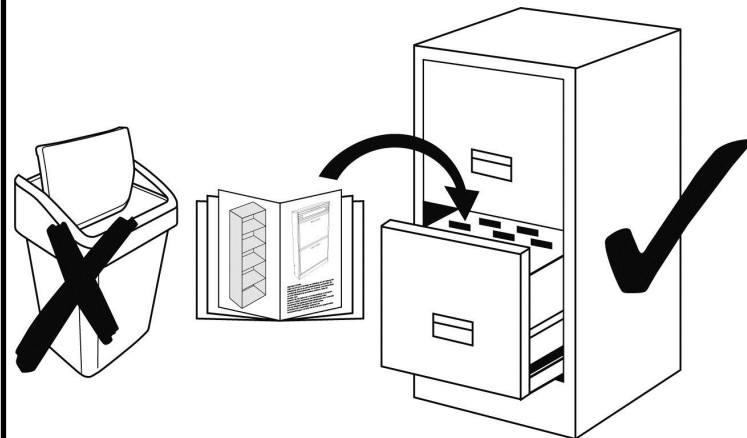

Ø5 x 70 mm
(6500570)



DK Ved ophængning af modul skal De selv sikre Dem væggenes beskaffenhed. Vort ansvar dækker kun den belastning, som selve reolen kan bære. Er De i tvivl kontakt da venligst en fagmand.

GB Before wall mounting of the modules, you have to make sure of the character of the wall. We are only responsible for the carrying capacity of the modules. In case of doubt, please contact an expert.

D Vor Aufhängen der Elemente müssen Sie die Beschaffenheit der Wand sichern. Wir tragen nur die Verantwortung für die Belastungsfähigkeit der Elemente. Im Zweifelsfall, wenden Sie sich bitte an einen Fachmann.

FR En suspension de l'étagère, vous êtes responsable de la qualité du mur. Notre responsabilité ne comprend que le poids que l'étagère peut supporter. En cas de doute, veuillez consulter un expert.

IT Prima di montare lo scaffale è tua responsabilità assicurarti di aver scelto una parete adatta a tale scopo. Noi siamo responsabili solamente per la capacità di carico dello scaffale. In caso di dubbi contatta uno specialista.

NL Bij het monteren van het schap bent u ervoor verantwoordelijk dat de wand geschikt is voor het beoogde doel. We zijn alleen verantwoordelijk voor de belasting die de plank zelf kan dragen. Neem bij twijfel contact op met een specialist.

PL Podczas montażu półki należy upewnić się, że ściana jest odpowiednia do zaplanowanego zastosowania. Nasza firma jest odpowiedzialna wyłącznie za obciążenie, jakie może wytrzymać sama półka. W przypadku wątpliwości należy skontaktować się ze specjalistą.

CZ Při montáži poličky zodpovídáte za to, že zkontrolujete, že stěna je vhodná pro zamýšlený účel. Neseme zodpovědnost pouze za to, že polička unese zatížení, které dokáže unést. V případě pochybností kontaktujte odborníka.

SK Pri sestavljanju police ste odgovorni za to, da se prepričate, ali je stena primerna za predvideni namen. Mi smo odgovorni le za obremenitev same police. V primeru dvoma se obrnite na strokovnjaka.

HU A polc felszerelése során Önnek kell meggyőződnie arról, hogy a fal alkalmas erre a célra. Cégünk csak azért a terhelésért vállal felelősséget, amelyet a polc elbír. Kérdés esetén forduljon szakemberhez.

RO Când asamblați raftul, dvs. sunteți responsabil să vă asigurați că peretele este potrivit pentru acest scop. Noi suntem responsabili doar pentru greutatea pe care raftul o poate suporta. În cazul în care aveți nelămuriri, vă rugăm să contactați un specialist.

TR Rafı birleştirinceğinizde, duvarın amaca uygun olmasını güvence altına almalısınız. Bizim tek sorumlu olduğumuz nokta, rafın kaldırabileceği yüküdür. Sizi rahatsız neden bir nokta olduğunda, lütfen bir uzmanla irtibata geçin.

RU При монтаже полки, вы ответственны за выбор стены, пригодной для назначенной цели. Мы несем ответственность исключительно за нагрузку, которую способна выдержать сама полка. Если у вас возникли сомнения, пожалуйста, свяжитесь со специалистом.

SV Vid upphängning på väggen skall ni först och främst säkerställa väggens hållbarhet/skick. Vårt ansvar täcker endast modulens hållbarhet/viktbelastning enligt informationen. Är ni osäkra på väggens hållbarhet är det rekommenderat att ni kontaktar en fackman.