

Notice de montage  
Assembling instructions  
Montageanleitung



1h



TEMAHOME





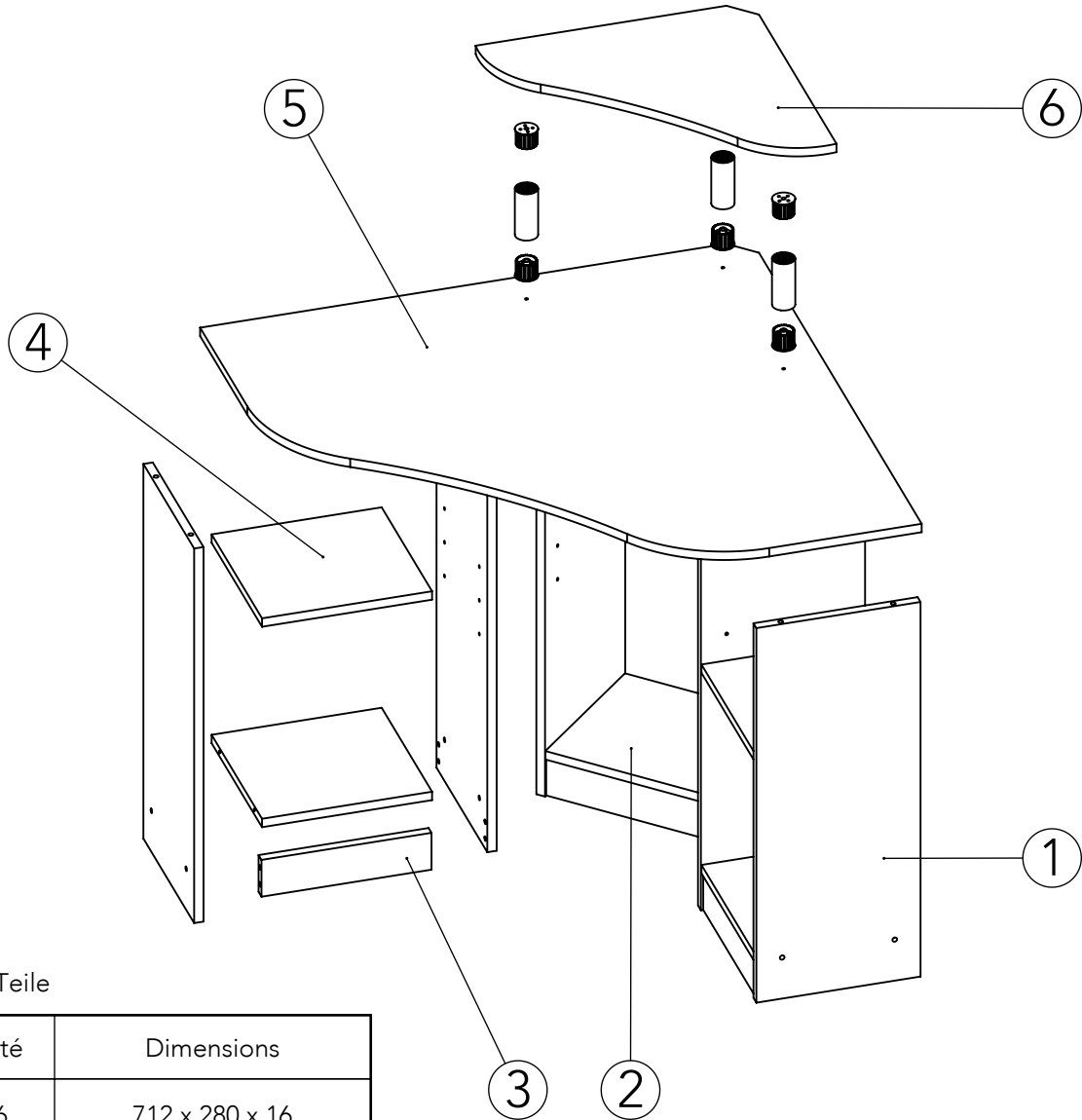
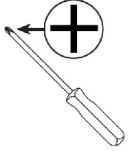
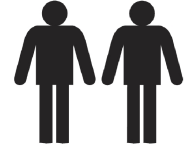





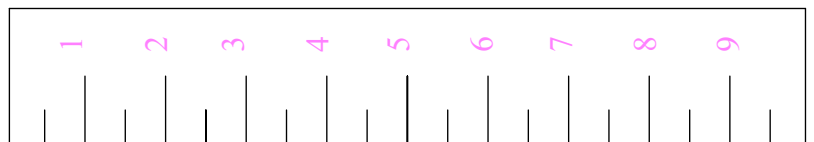

CORNER  
1112 IC (Prod Ref.)



N° Pièce / Part / Teile

N° Pièce	Qté	Dimensions
1	6	712 x 280 x 16
2	3	290 x 278 x 16
3	3	290 x 70 x 16
4	3	290 x 278 x 16
5	1	940 x 940 x 16
6	1	470 x 470 x 16



Code	Qté	Image
AA	12	
BA	12	
CA	12	 6.3 x 50 mm
DA	12	
DD	12	
ID	24	 4 x 30 mm
FD	6	 6.3 x 19 mm
EC	12	
RWB	6	
RVB	3	
Clef	1	

1

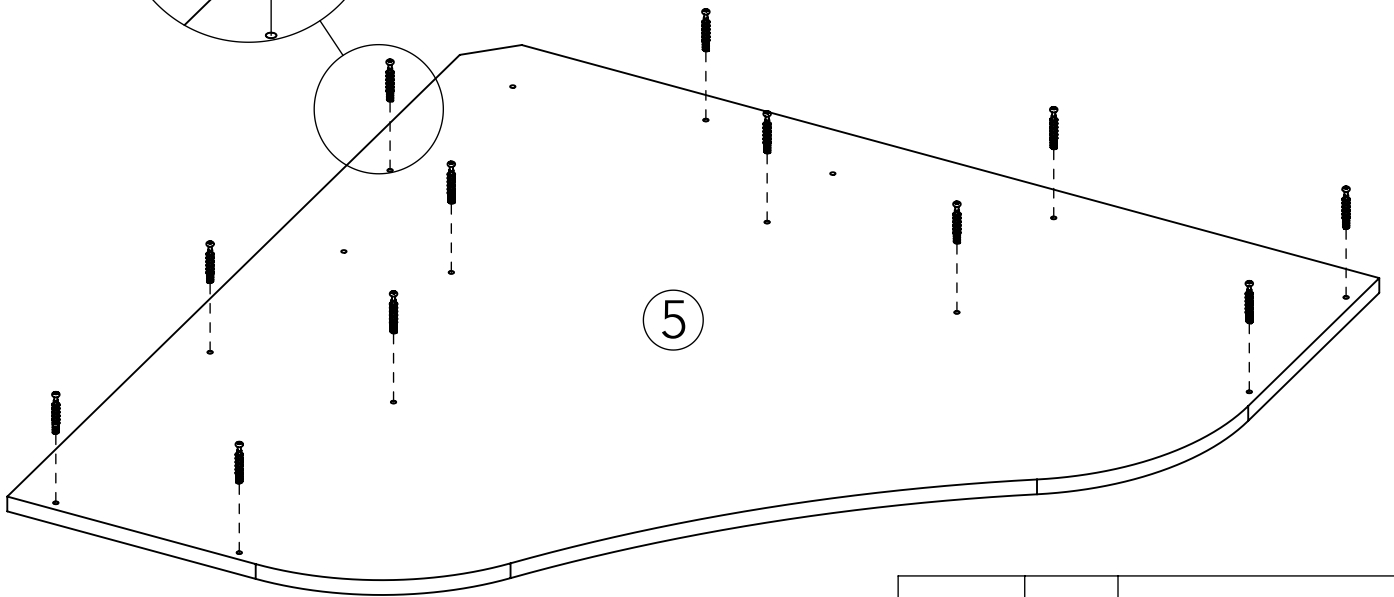
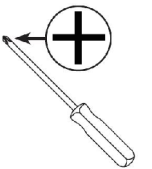
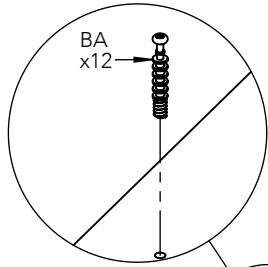

Code	Qté	Image
BA	12	

2

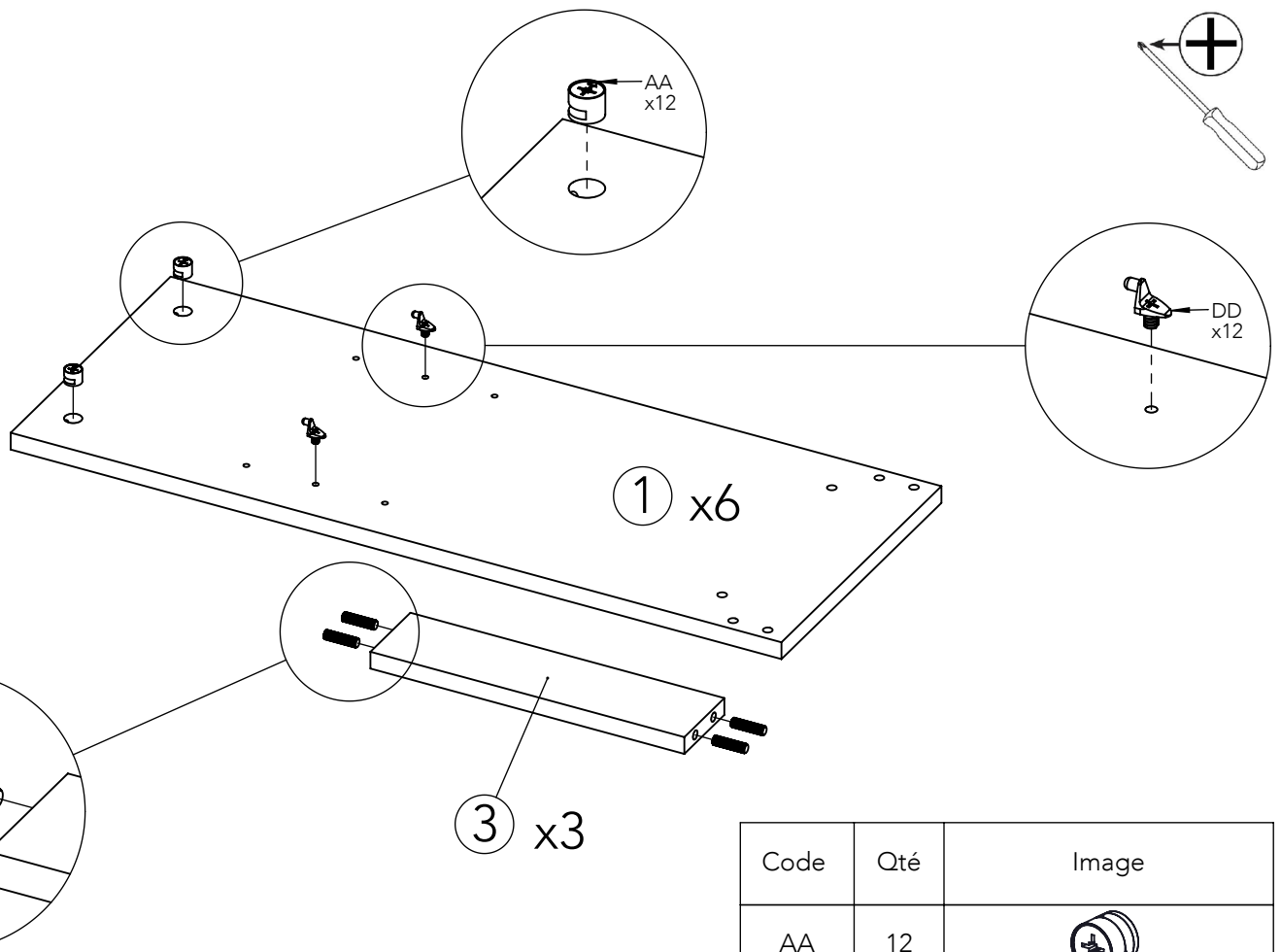

Code	Qté	Image
AA	12	
DA	12	
DD	12	

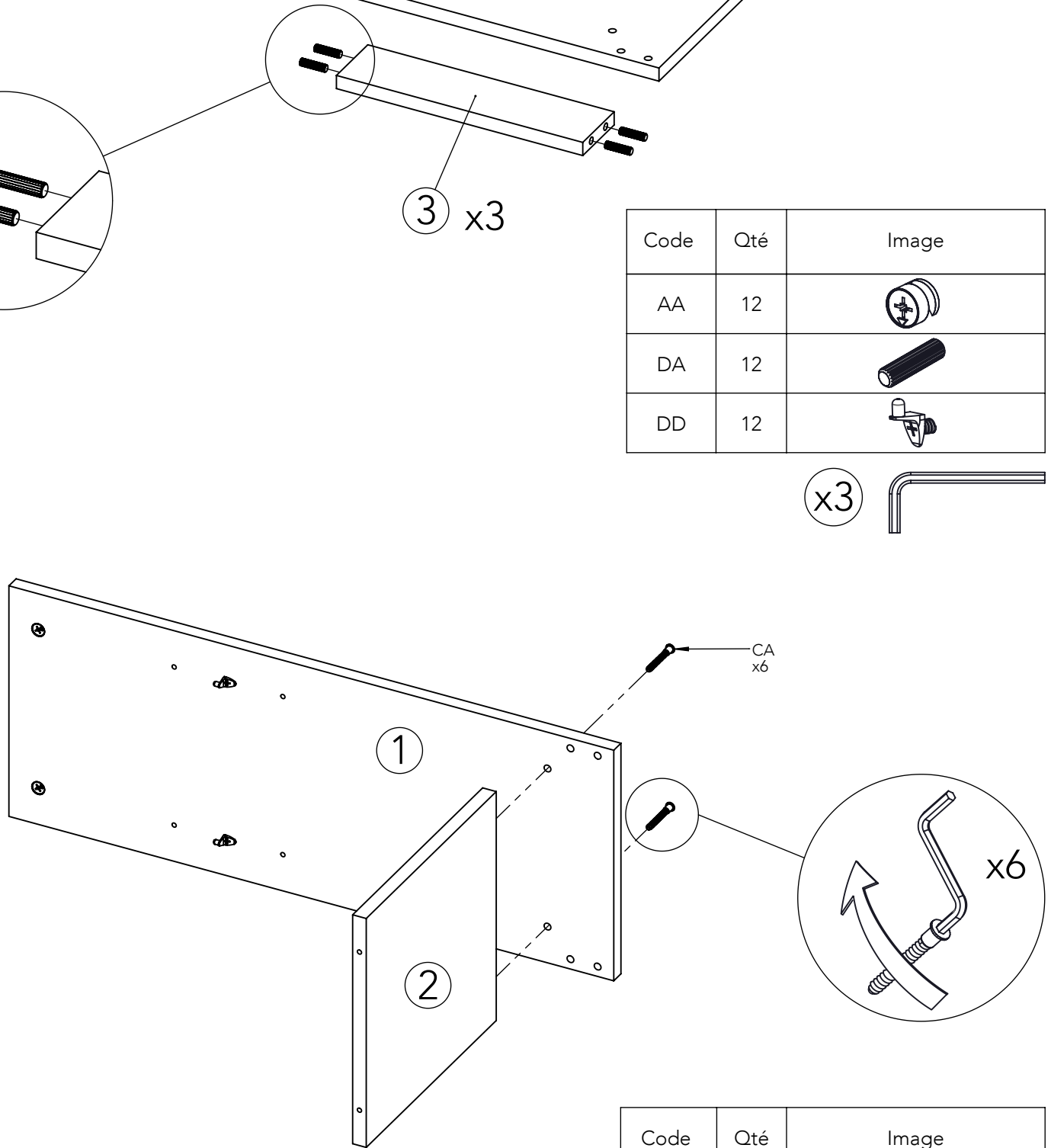

3

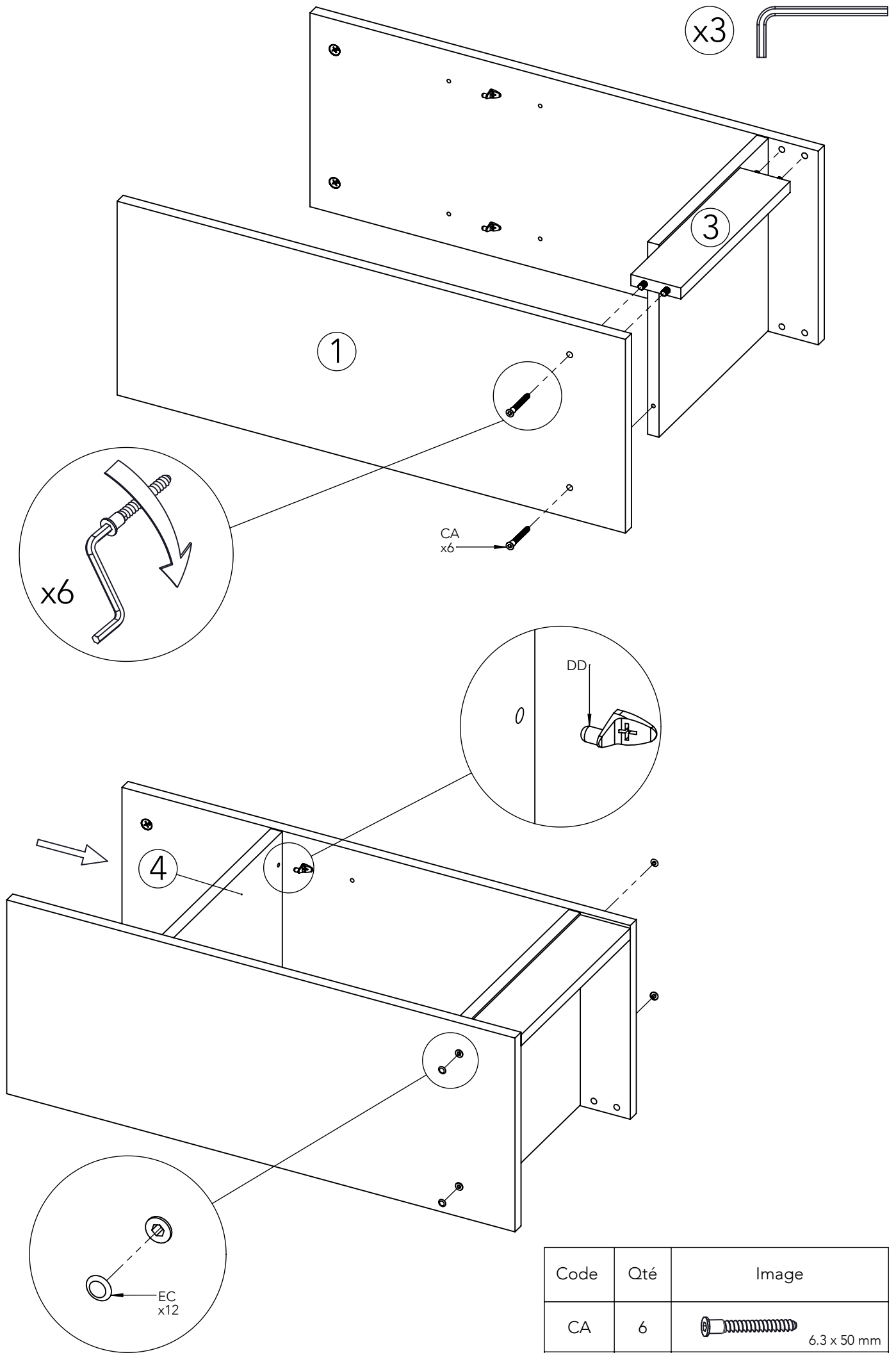

Code	Qté	Image
CA	6	

4



Code	Qté	Image
CA	6	 6.3 x 50 mm
EC	12	

5

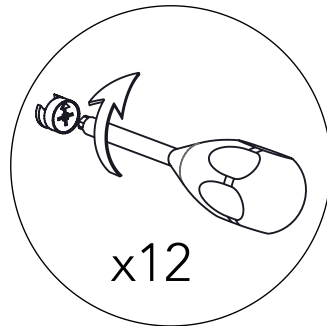
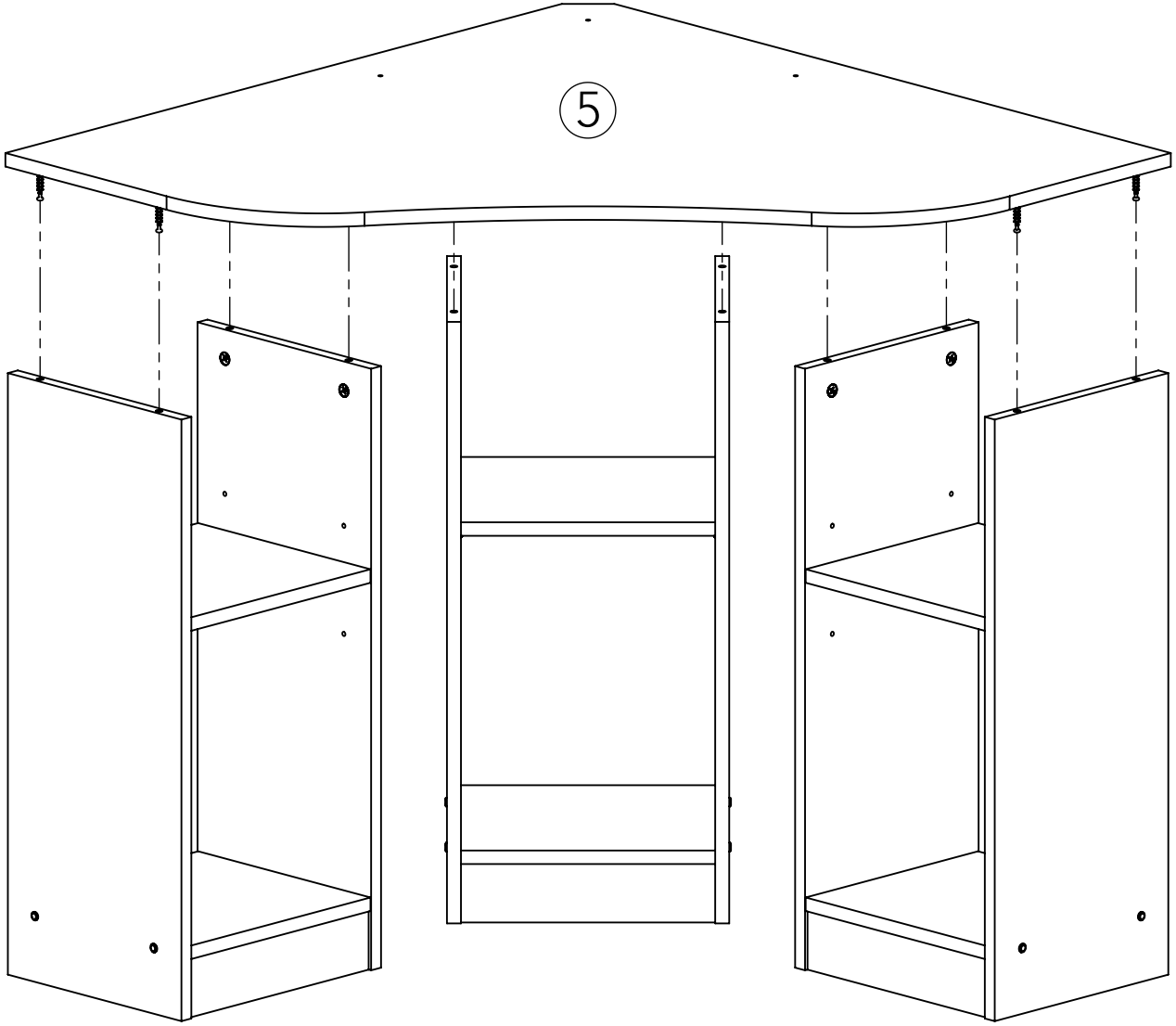
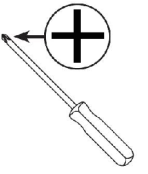

x12

6

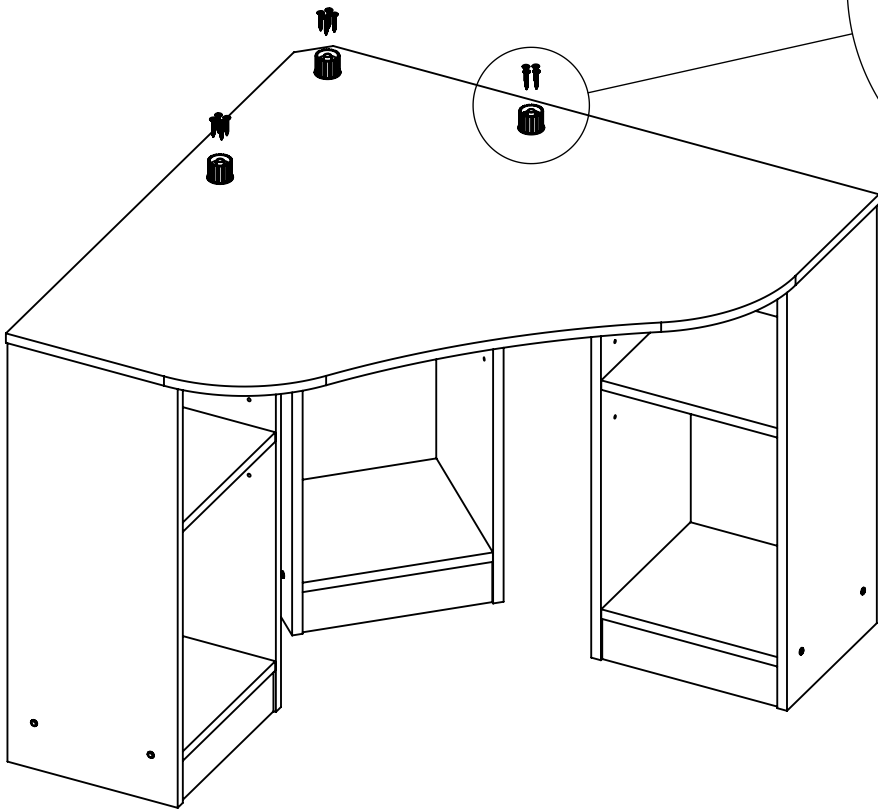
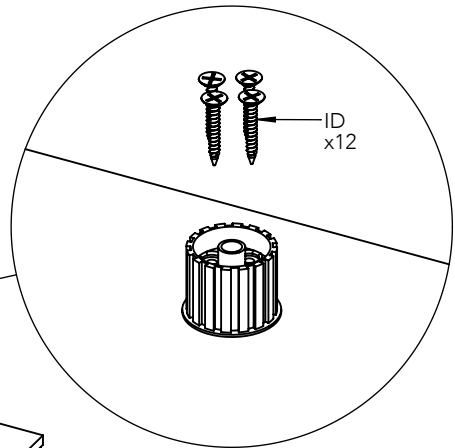
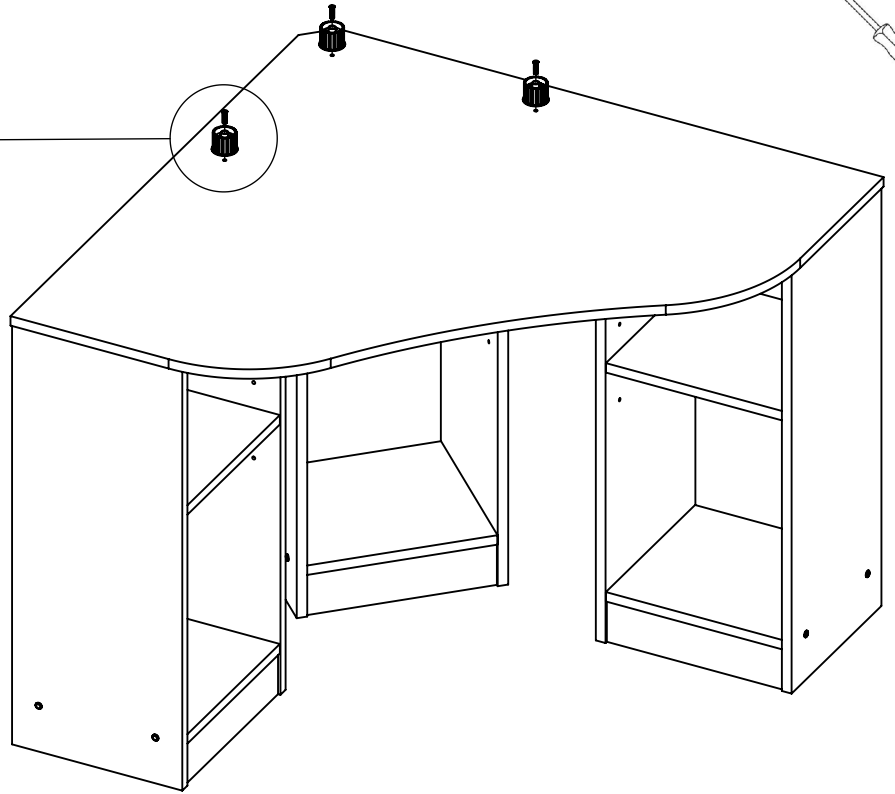
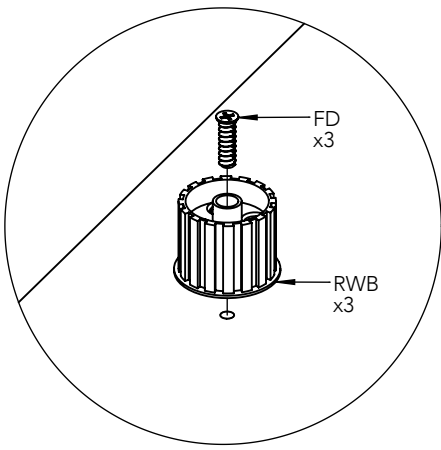
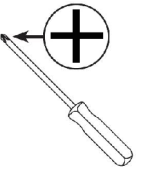

Code	Qté	Image
RWB	3	
FD	3	6.3 x 19 mm
ID	12	4 x 30 mm

7

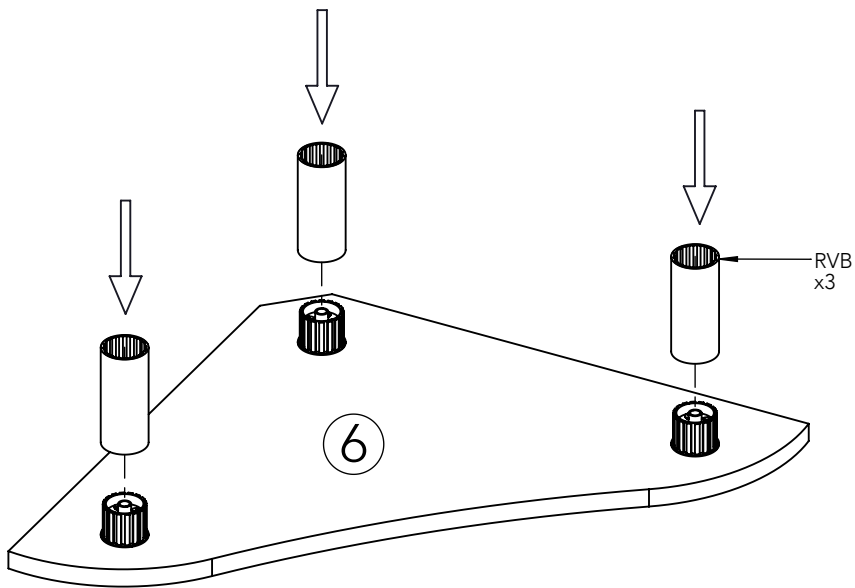
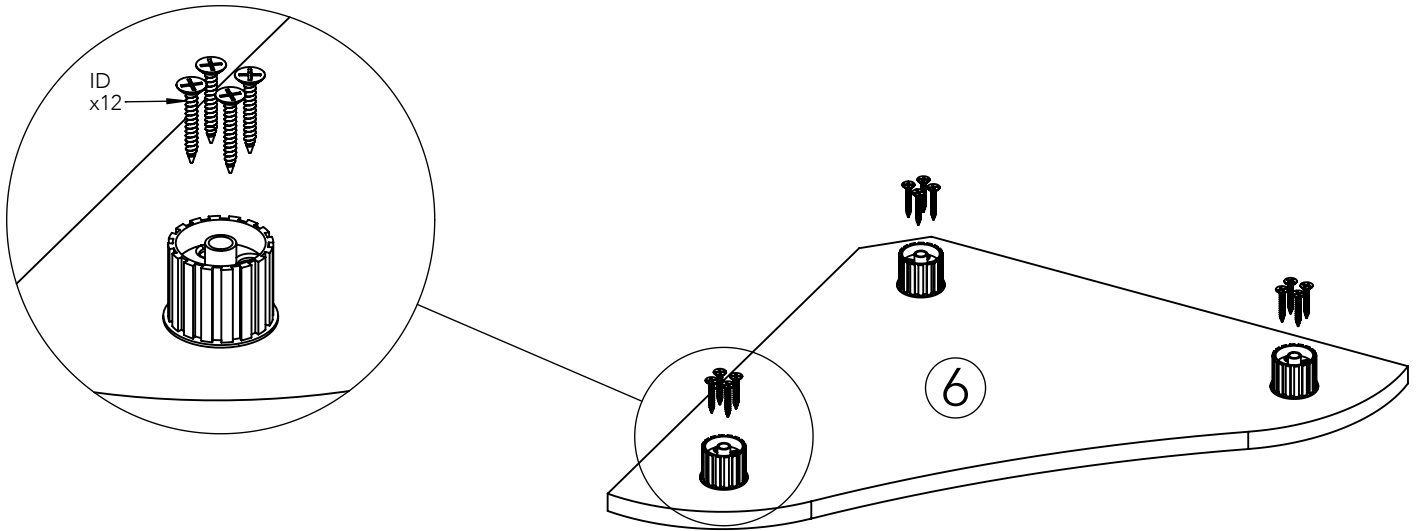
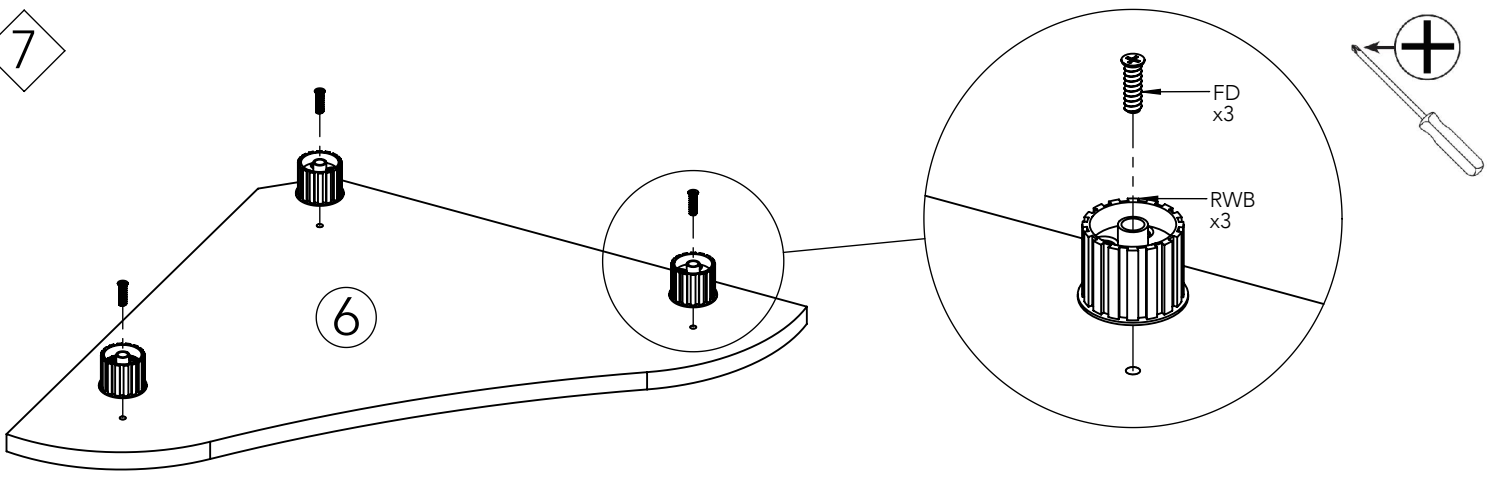

Code	Qté	Image
RVB	3	
RWB	3	
FD	3	6.3 x 19 mm
ID	12	4 x 30 mm

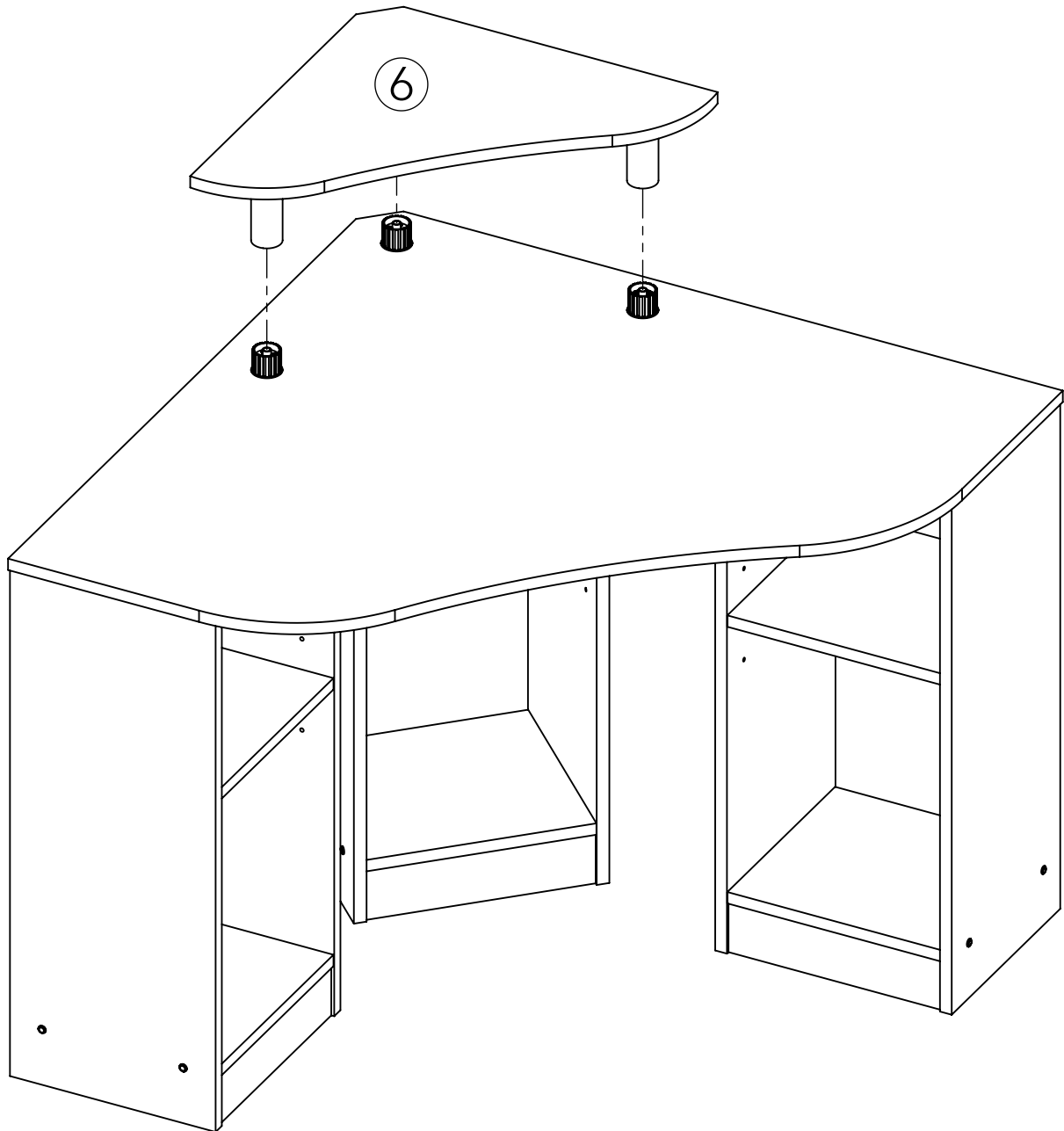

#### INSTRUCTIONS D'ENTRETIEN

Laver les surfaces à l'aide d'un chiffon doux, préalablement trempé dans une solution savonneuse (max. 1%).  
**ATTENTION!** Ne pas utiliser de produit contenant de l'alcool ou de l'abrasif.  
 Essuyer à l'aide d'un chiffon doux.

#### CARE AND CLEANING INSTRUCTIONS

Wash the surfaces with a soft cloth damped in a mild soap solution (max 1%).  
**NOTE!** Do not use cleaners containing alcohol or abrasives.  
 Wipe the surface dry with a soft cloth.

#### PFLEGEHINWEIS

Zur Reinigung und Pflege verwenden sie, ein feuchter Lappen mit Seifenlauge (max 1%) zum Abwischen  
**WICHTIG!** Keine alkoholhaltigen Mittel oder Schleifmittel verwenden.  
 Die Oberfläche mit einem weichen Tuch abtrocknen.

