

- (D) Montageanleitung
- (NL) Handleiding voor de montage
- (HU) Szerelési útmutató
- (GB) Assembly instructions

- (PL) Instrukcja montażu
- (RO) Instrucțiuni de montaj
- (FR) Notice de montage
- (CZ) Montážní návod
- (TR) Montaj talimatı
- (IT) Istruzioni di montaggio
- (SK) Návod na montáž
- (RU) Инструкция по монтажу

**Service • Assistenza • Dienstverlening • Serwis
Servis • Szerviz • Сервисная служба**

Name • Nom • Nome • Naam •
Nazwa • Jméno • Názov • Név •
Denumire • Ísim • Название

Nr. • No. • N° • Номер • Č. • Sz

Typ • Type • Tip • Típus • Тиро •
Тип

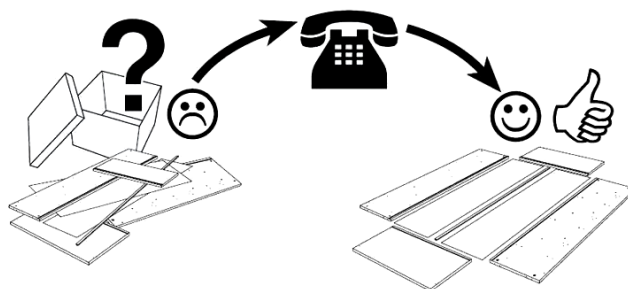
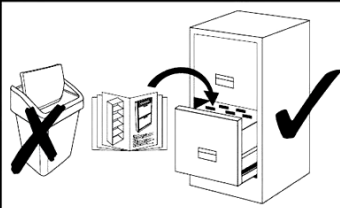

1	1x	ca. 2002 x 330 mm
2	1x	ca. 1981 x 330 mm
3	1x	ca. 2002 x 330 mm
4	2x	ca. 318 x 330 mm
5	1x	ca. 318 x 315 mm
6	1x	ca. 318 x 315 mm

7	1x	ca. 1074 x 174 mm
8	1x	ca. 1044 x 307 mm
9-L	1x	ca. 310 x 104 mm
9-M	1x	ca. 1032 x 104 mm
9-R	1x	ca. 310 x 104 mm
10	2x	ca. 352 x 459 mm
11	1x	ca. 1065 x 315 mm

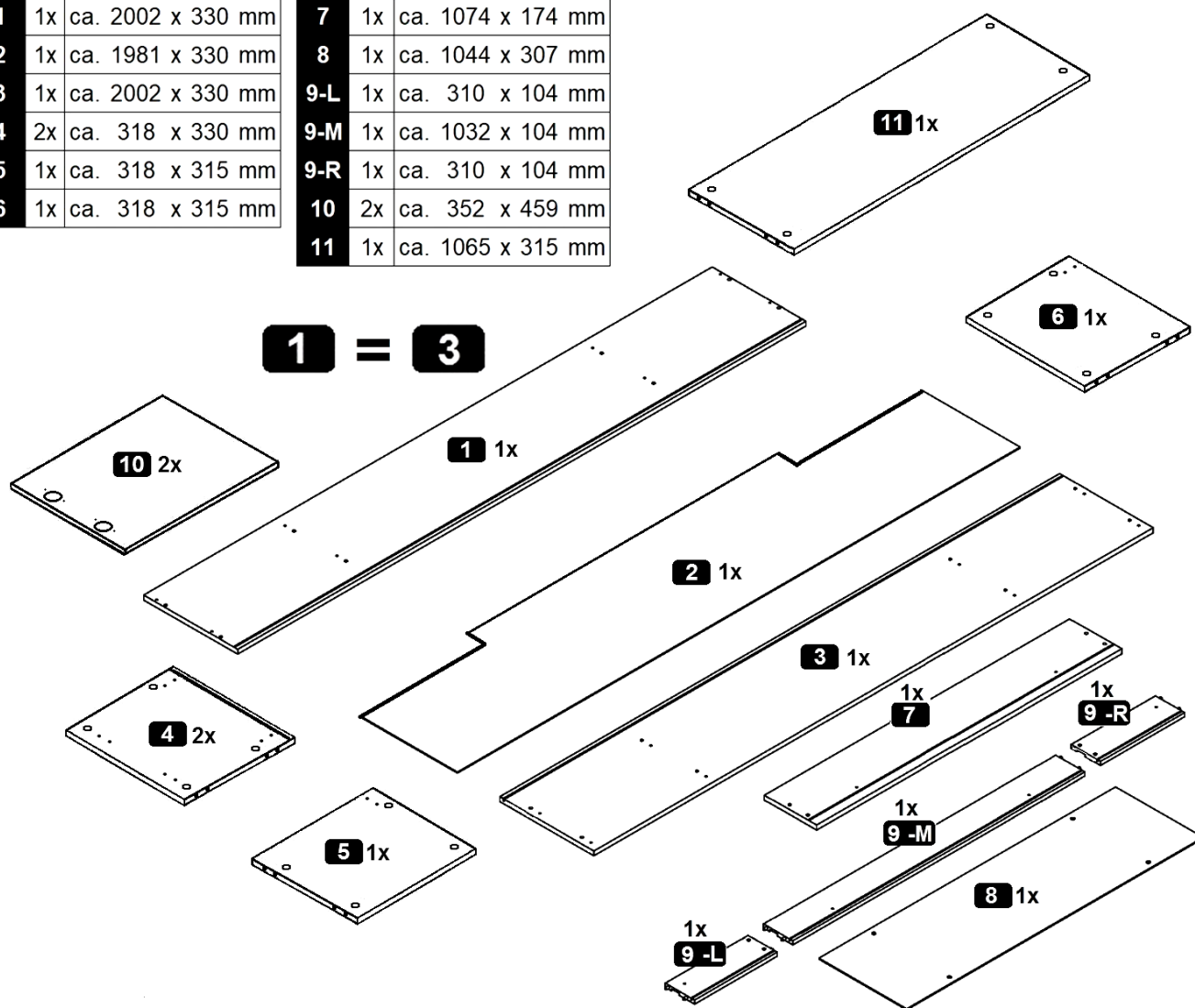

A 8,0 x 30 mm 20x	B 20x	C 20x	D 2x	E 2x	F 6x	G 4,0 x 20 mm 6x
H Ø35 Kr.0 4x	I h=2 4x	J M4,0 x 9 mm 2x	K 2,7 x 20 mm 6x	L 27 x 310 mm 2x	M 6,3 x 13 mm 16x	
N 1x	O 4x	P 4x	Q 4x			

- (D)** Bei hängender Montage kann der untere Schritt [1] entfallen.
- (GB)** The lower step [1] can be omitted for hanging installation.
- (FR)** La marche inférieure [1] peut être omise pour une installation suspendue.
- (IT)** Il gradino inferiore [1] può essere omissso per l'installazione sospesa.
- (NL)** Bij hangende montage kan de onderste trede [1] worden weggelaten.
- (PL)** Dolny stopień [1] można pominąć w przypadku montażu wiszącego.
- (CZ)** Dolní schod [1] lze u závěsné instalace vynechat.
- (RO)** Pasul inferior [1] poate fi omis pentru instalarea suspendată.
- (HU)** Az alsó lépcső [1] a függesztéshez elhagyható.
- (SK)** Dolný schod [1] je možné pre závesnú inštaláciu vynechať.
- (TR)** Aslı kurulum için alt adım [1] atlanabilir.
- (RU)** Нижнюю ступеньку [1] можно не устанавливать при подвесной установке.



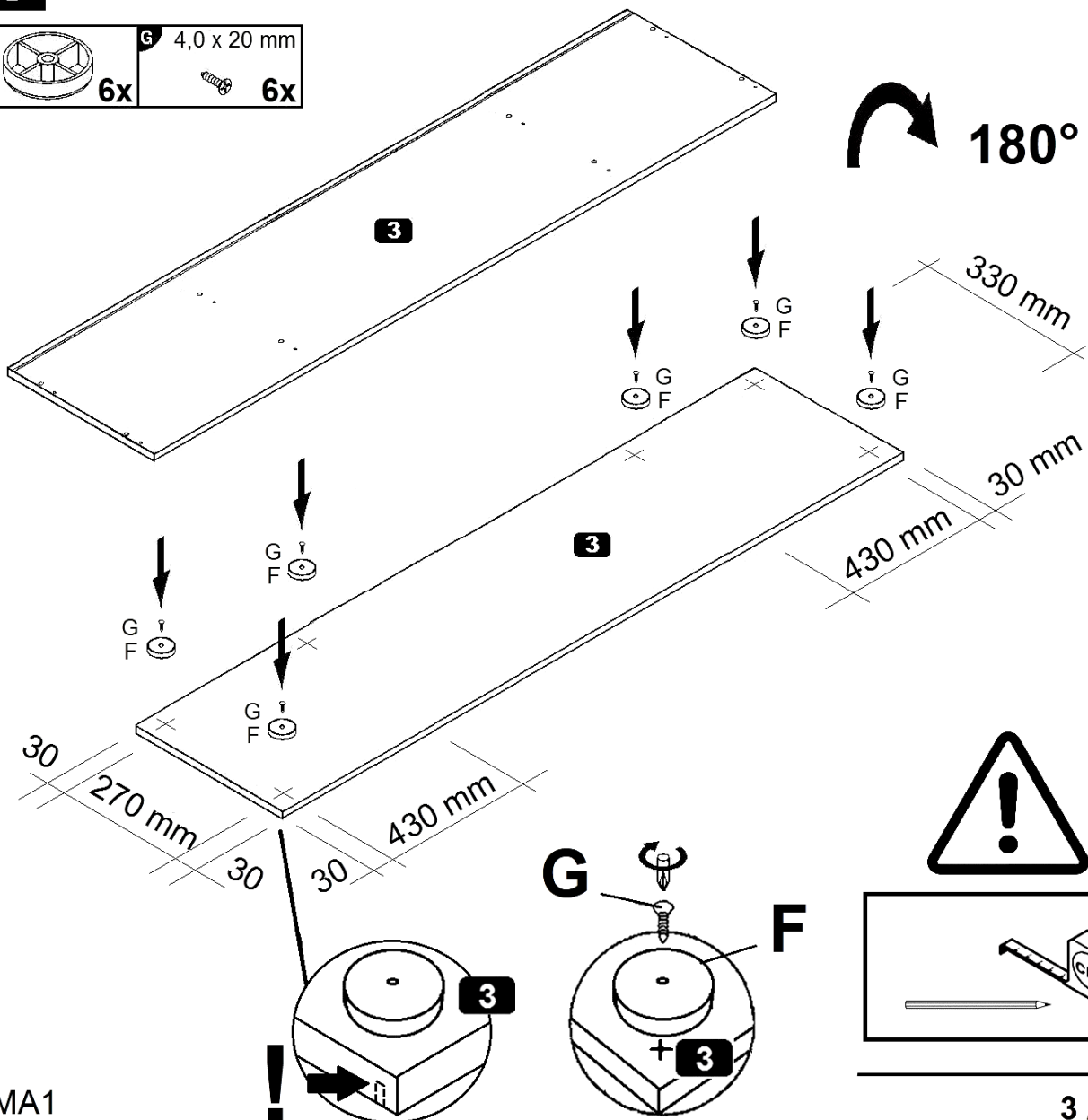
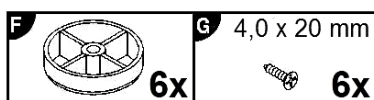



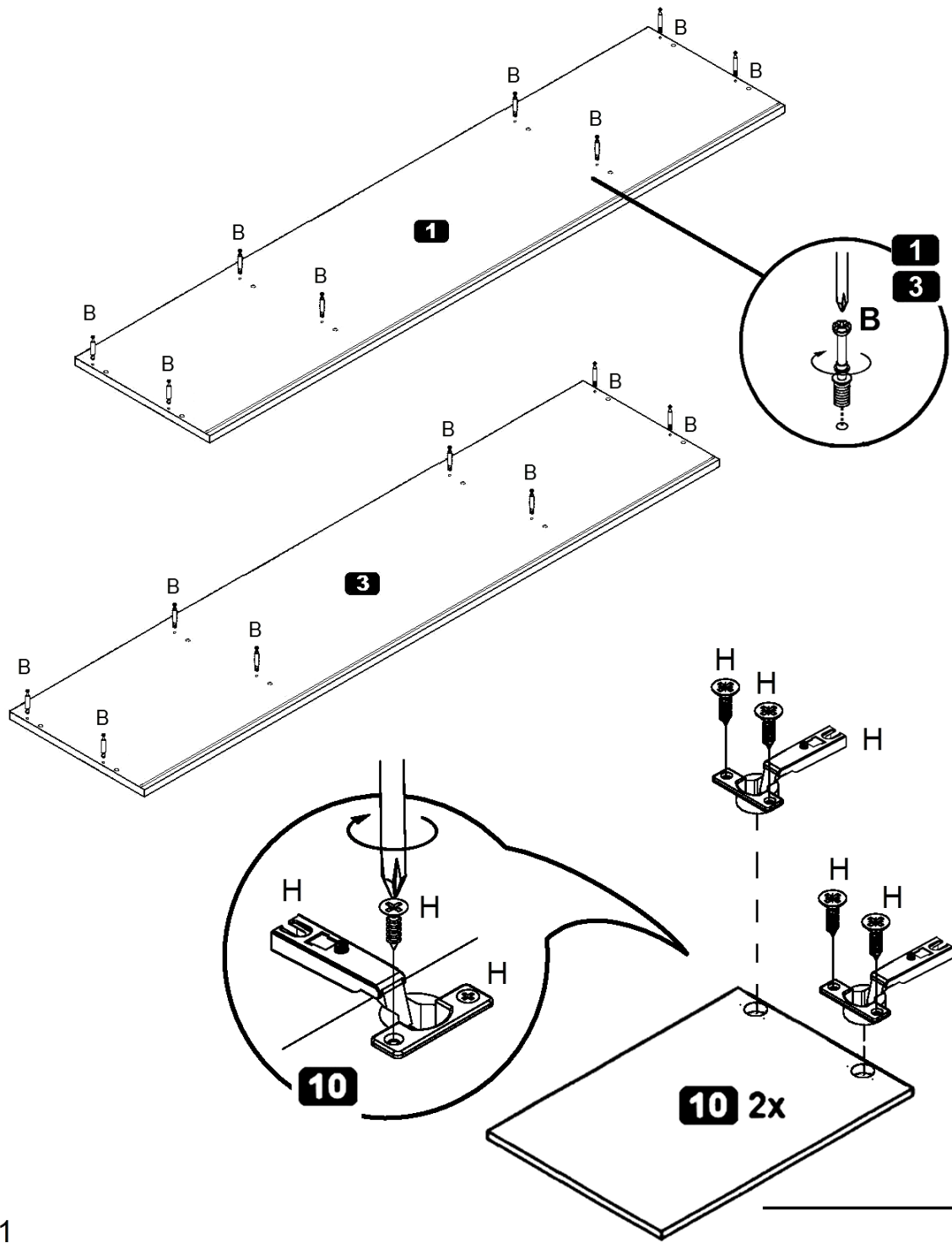
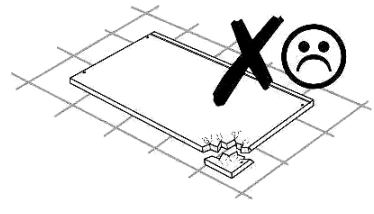
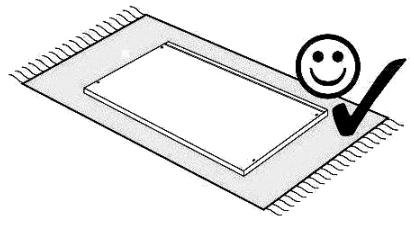
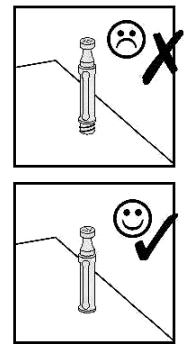
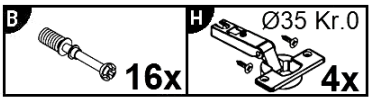

1

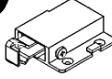

MA1

2

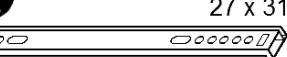

3	A 8,0 x 30 mm	B						
	 20x	 4x						
C	D	E	I	L	M			
 20x	 2x	 2x	 h=2 4x	 27 x 310 mm 2x	 6,3 x 13 mm 12x			

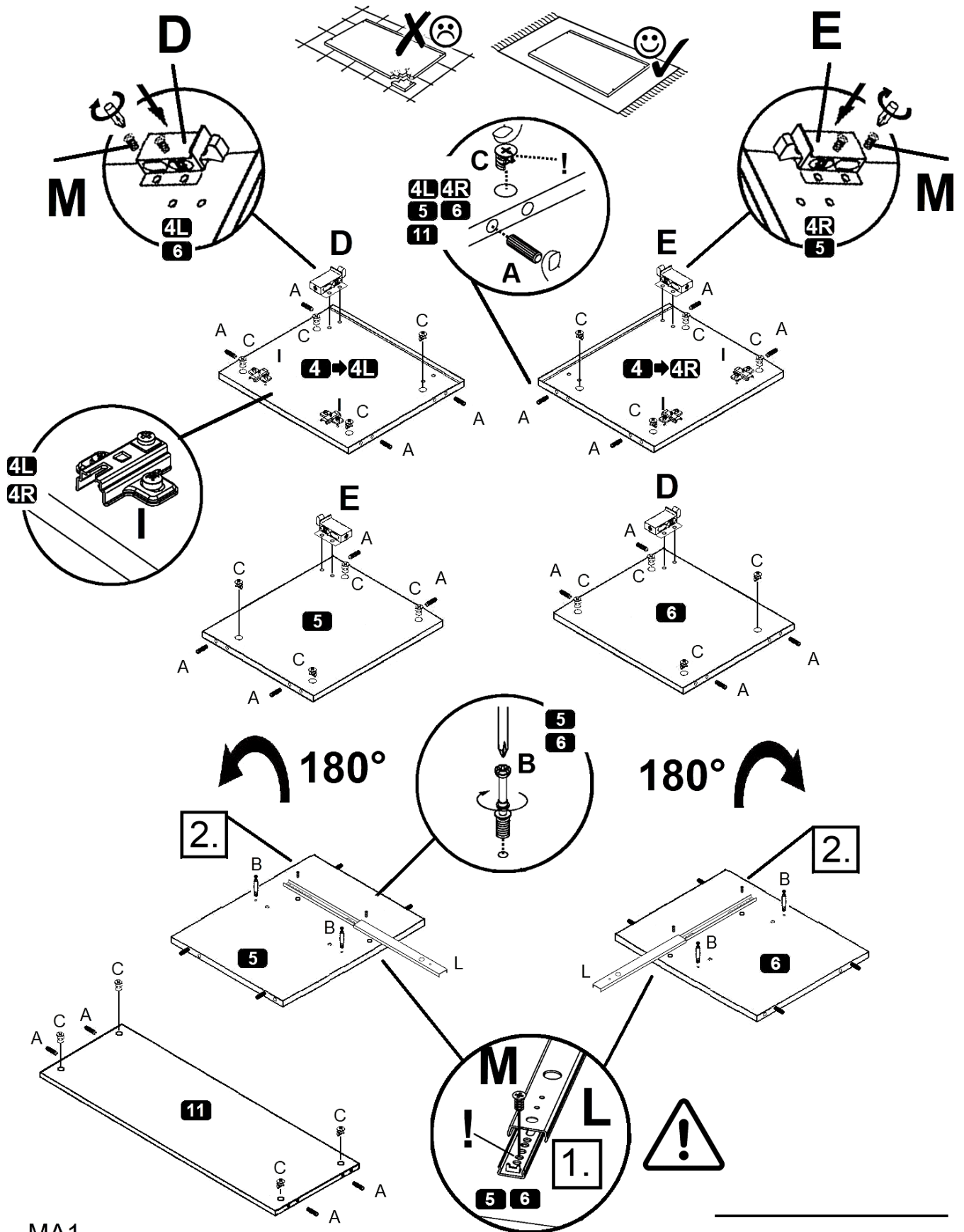

4

M 6,3 x 13 mm



4x



4x

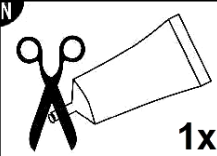

1x

- D Leim
- GB Glue
- FR Colle
- IT Colla
- NL Lijm
- PL Klej
- CZ Lepidlo
- SK Glej
- HU Enyv
- RO Adeziv
- TR Tutkal
- RU Клей

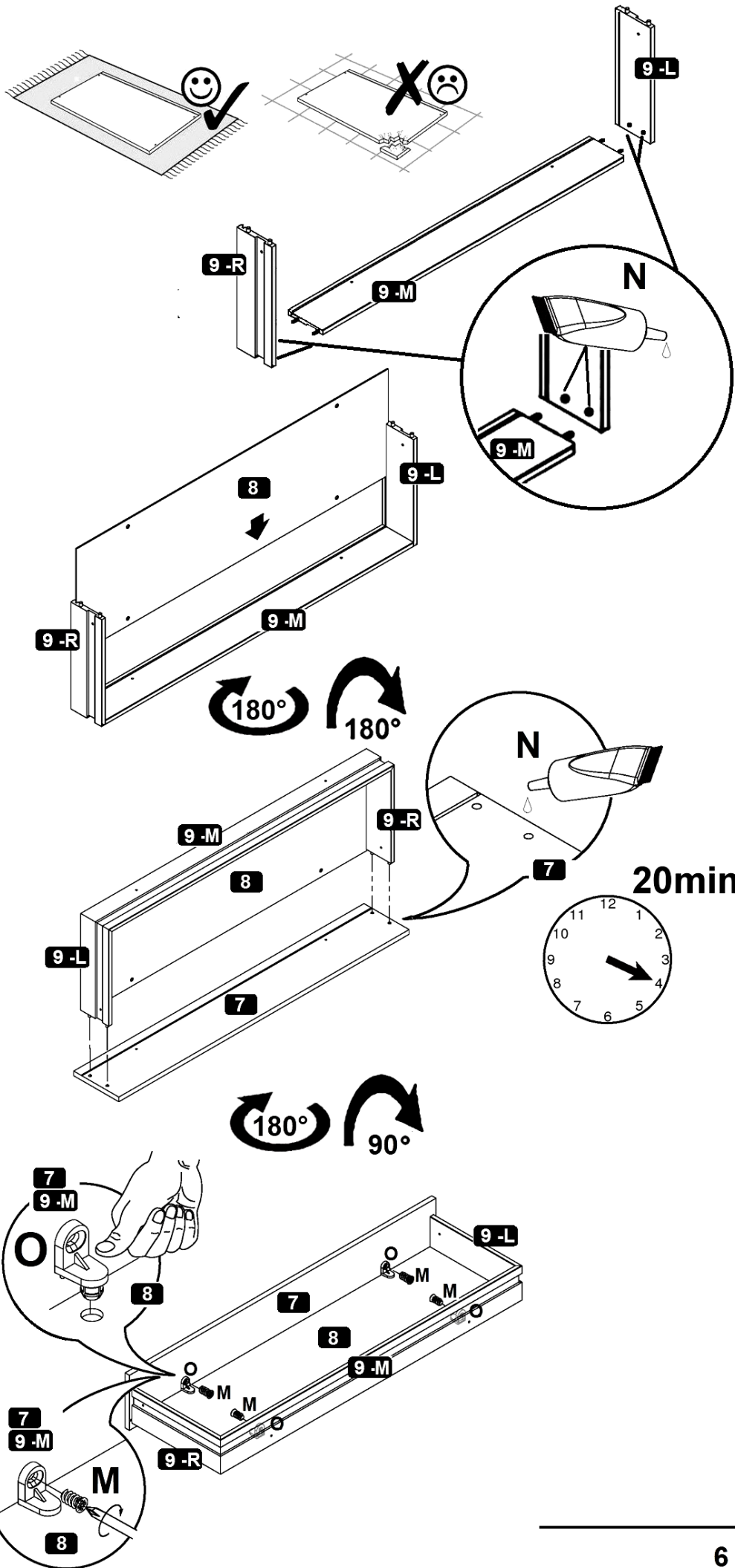

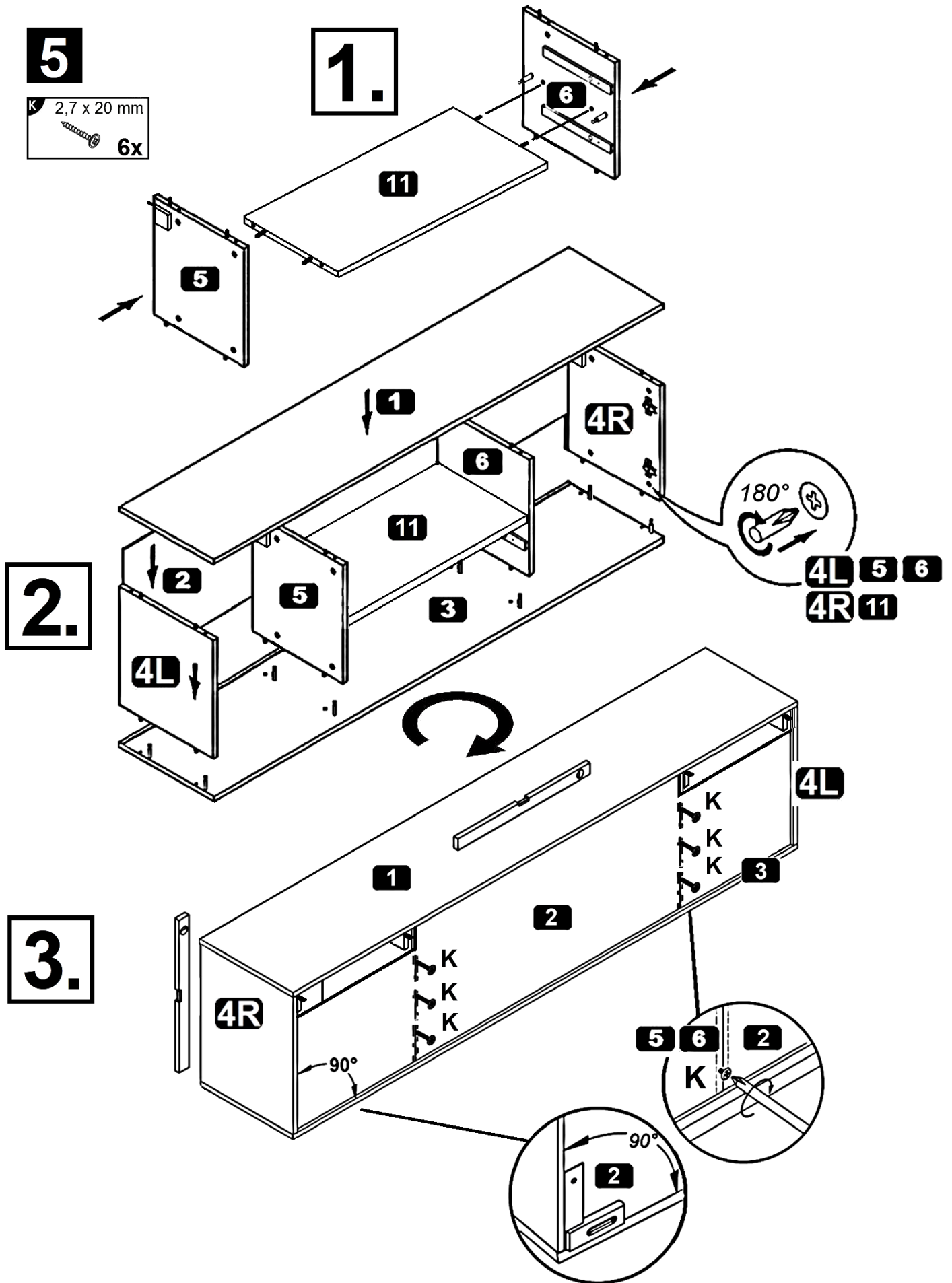

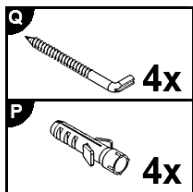
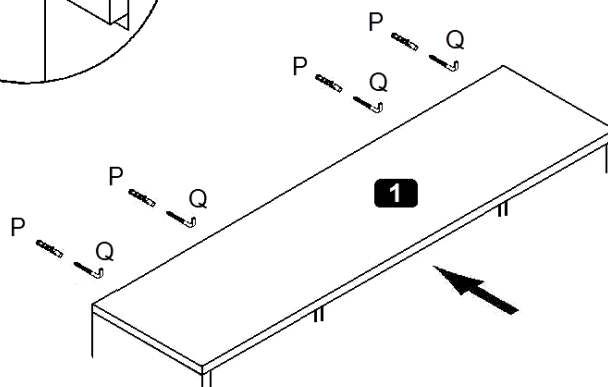
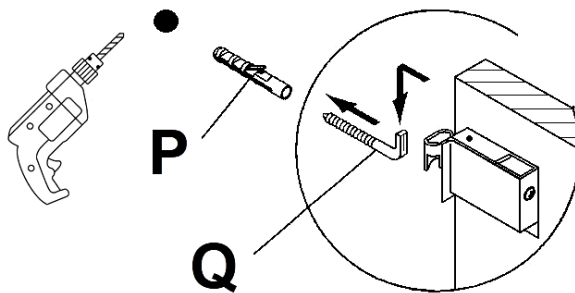
6**Ø8mm****D**

Das beigelegte Wandbefestigungsmaterial (Dübel und Schrauben) eignet sich nur für festes Mauerwerk (z.B. Beton- oder Ziegelwände). Für andere Wandaufbauten sind eventuell Spezialdübel und andere Schrauben notwendig. Ziehen Sie gegebenenfalls eine Fachkraft zurate.

FR

Le matériel de fixation murale fourni (chevilles et vis) convient uniquement à des murs solides (p. ex. murs en béton ou en briques). Pour les autres constructions de murs, il faut éventuellement des chevilles spéciales et d'autres vis. Faites-vous conseiller par un spécialiste.

NL

Het bijgeleverde bevestigingsmateriaal (pluggen en schroeven) is geschikt voor vaste muren (bijv. betonnen of bakstenen muren). Voor andere muurconstructies zijn eventueel speciale pluggen en andere schroeven noodzakelijk. Consulteer eventueel een vakman.

CZ

Příložený materiál pro montáž na stěnu (hmoždinky a šrouby) je vhodný jen pro pevné zdivo (např. betonové nebo cihlové stěny). Pro jiné skladby stěn budou případně nutné speciální hmoždinky a jiné šrouby. Poradte se případně s odborníkem.

HU

A mellékelt fali rögzítőkészlet (tiplé és csavarok) csak tömött falazatban (pl. betonfalban, téglafalban) használható. Más fal típusokhoz speciális tiplire és csavarra lesz szükség. Szükség esetén kérje ki egy szakember véleményét.

TR

Teslimat kapsamındaki duvar tipi sabitleme materyali (dübel ve vidalar) sadece beton ve tuğla duvarları gibi sağlam duvar yapıları için uygundur. Başka duvar yapıları için özel dübeller veya başka vidalar gerekli olabilir. Gerekirse bir uzmandan yardım alınız.

GB

The enclosed wall mounting materials (dowels and screws) are only suitable for solid masonry (e. g. concrete or brick walls). Special dowels and other screws may be necessary for other wall constructions. If necessary, please consult a qualified professional.

IT

I materiali di fissaggio allegati (tasselli e viti) sono adatti solo ai muri compatti (ad es. di calcestruzzo o mattoni). Per altri tipi di pareti è probabile che occorran tasselli speciali e altre tipologie di viti. Richiedere eventualmente il consiglio di un esperto.

PL

Załączony zestaw montażowy do zamocowania artykułu do ściany (kołki, wkręty, haki itp.), przeznaczony jest wyłącznie do montażu artykułu na ścianach wykonanych z cegły lub betonu. Przy montażu artykułu na ścianie wykonanej z innych materiałów, należy zastosować odpowiednie do niej zamocowania. W razie wątpliwości prosimy zasięgnąć porady fachowca.

SK

Priložený materiál pre upevnenie na stenu (hmoždinky a skrutky) je vhodný len pre pevné murivo (napr. betónové alebo tehlové steny). Pre iné steny sú potrebné príp. špeciálne hmoždinky a iné skrutky. V prípade potreby sa poraďte s odborníkom.

RO

Materialul furnizat pentru montajul de perete (dibluri și șuruburi) este adecvat numai pentru zidărie solidă (de exemplu pereți din beton sau din cărămidă). Pentru alte structuri de pereți, este posibil să fie necesare dibluri speciale, precum și alte șuruburi. Dacă este necesar, consultați un specialist.

RU

Входящий в комплект поставки материал для крепления на стене (дюбели и болты) предназначен только для прочных каменных стен (например, бетонных или кирпичных). Для других типов стен используйте по мере необходимости специальные дюбели и другие болты. По мере необходимости обратитесь за помощью к специалистам.

7

M4,0 x 9 mm
2x

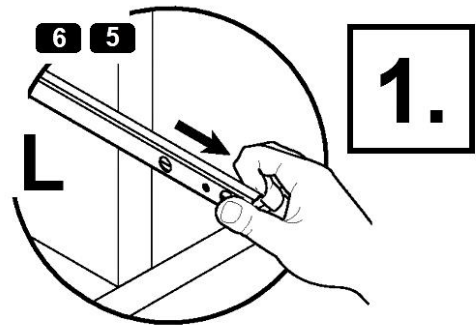
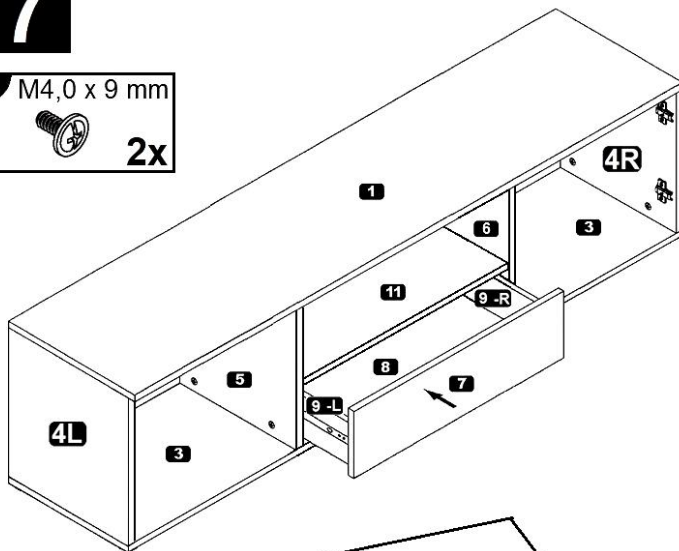
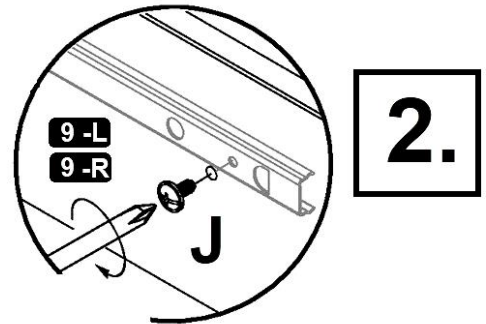
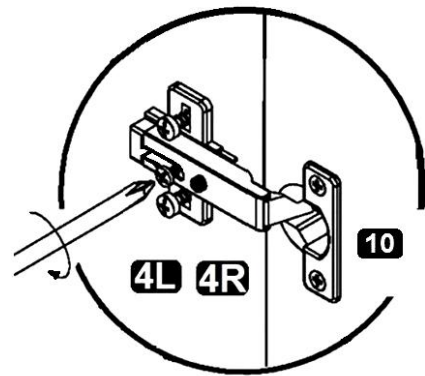
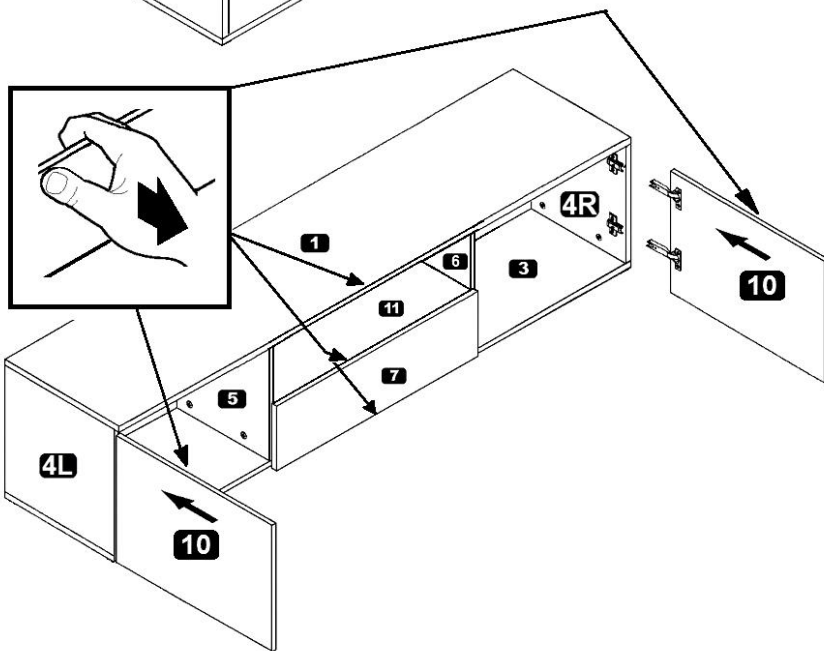
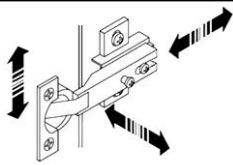
**1.****2.****➔ 10 / 10**

- (D) Türen einstellen
(Scharniere justieren)
- (GB) Adjusting the doors
(adjusting the hinges)
- (FR) Régler les portes
(ajuster les charnières)
- (IT) Sistemare le porte
(regolare le cerniere)

- (NL) Deuren instellen
(scharnieren afstellen)
- (PL) Nastawić drzwi
(wyregulować zawiasy)
- (CZ) Vyrovnajte dvířka
(seřid'te závěsy)
- (RO) Nastavenie dverí
(nastavenie závesov)
- (HU) Állítsa be az ajtókat
(állítsa be a zsanérokat)
- (SK) Reglare uši
(ajustare balamale)
- (TR) Kapıların ayarlanması
(menteşelerin seviye ayarı)
- (RU) Регулировка дверей
(регулировка шарнира)

8

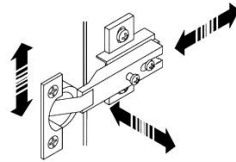

(D) Türen einstellen
(Scharniere justieren)

(GB) Adjusting the doors
(adjusting the hinges)

(FR) Régler les portes
(ajuster les charnières)

(IT) Sistemare le porte
(regolare le cerniere)

(NL) Deuren instellen
(scharnieren afstellen)

(PL) Nastawić drzwi
(wyregulować zawiasy)

(CZ) Vyrovnajte dvířka
(seřid'ťe závěsy)

(RO) Nastavenie dverí
(nastavenie závesov)

(HU) Állítsa be az ajtókat
(állítsa be a zsanérokot)

(SK) Reglare uši
(ajustare balamale)

(TR) Kapıların ayarlanması
(menteşelerin seviye ayarı)

(RU) Регулировка дверей
(регулировка шарнира)

