

# JASMIN 5K 21--08

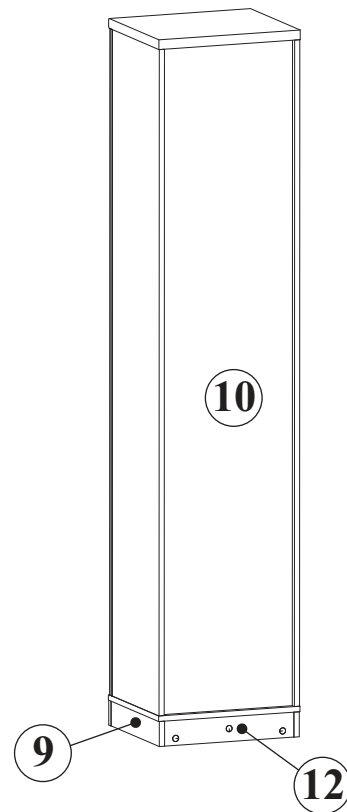

NO	Dim.			Col.-No	Qty
1	1918	353	16	2	1
2	1918	353	16	2	1
4	432	380	16	1	1
3	432	380	28	1	1
5	398	333	22	1	1
6	398	333	22	1	3
11	1918	43	19	2	2
7	430	72	16	1	1
12	396	72	16	1	1
8	363	72	16	1	1
9	363	72	16	1	1
10	1930	410	3	2	1

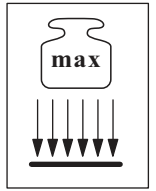

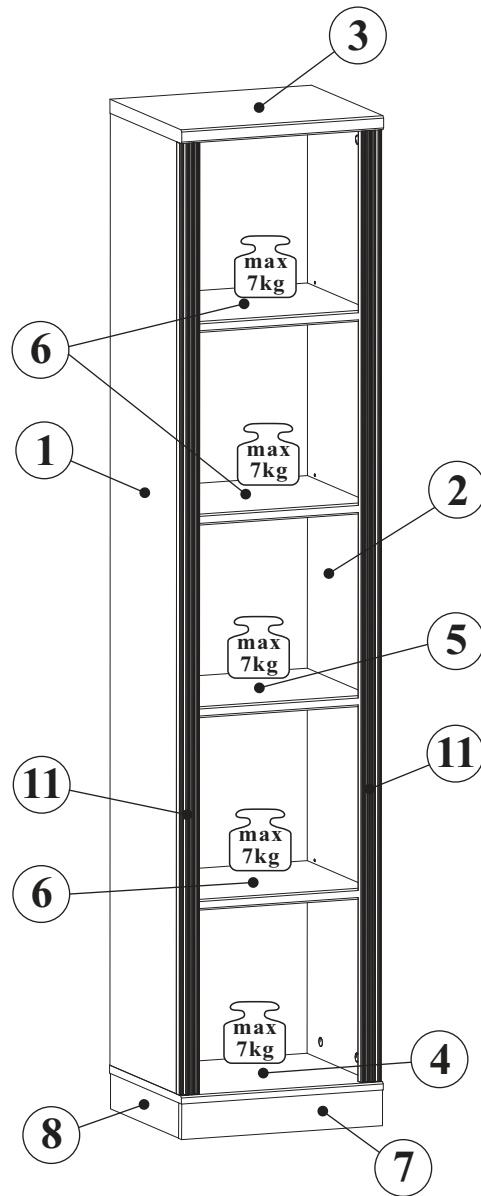
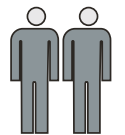

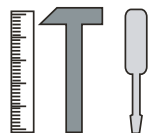

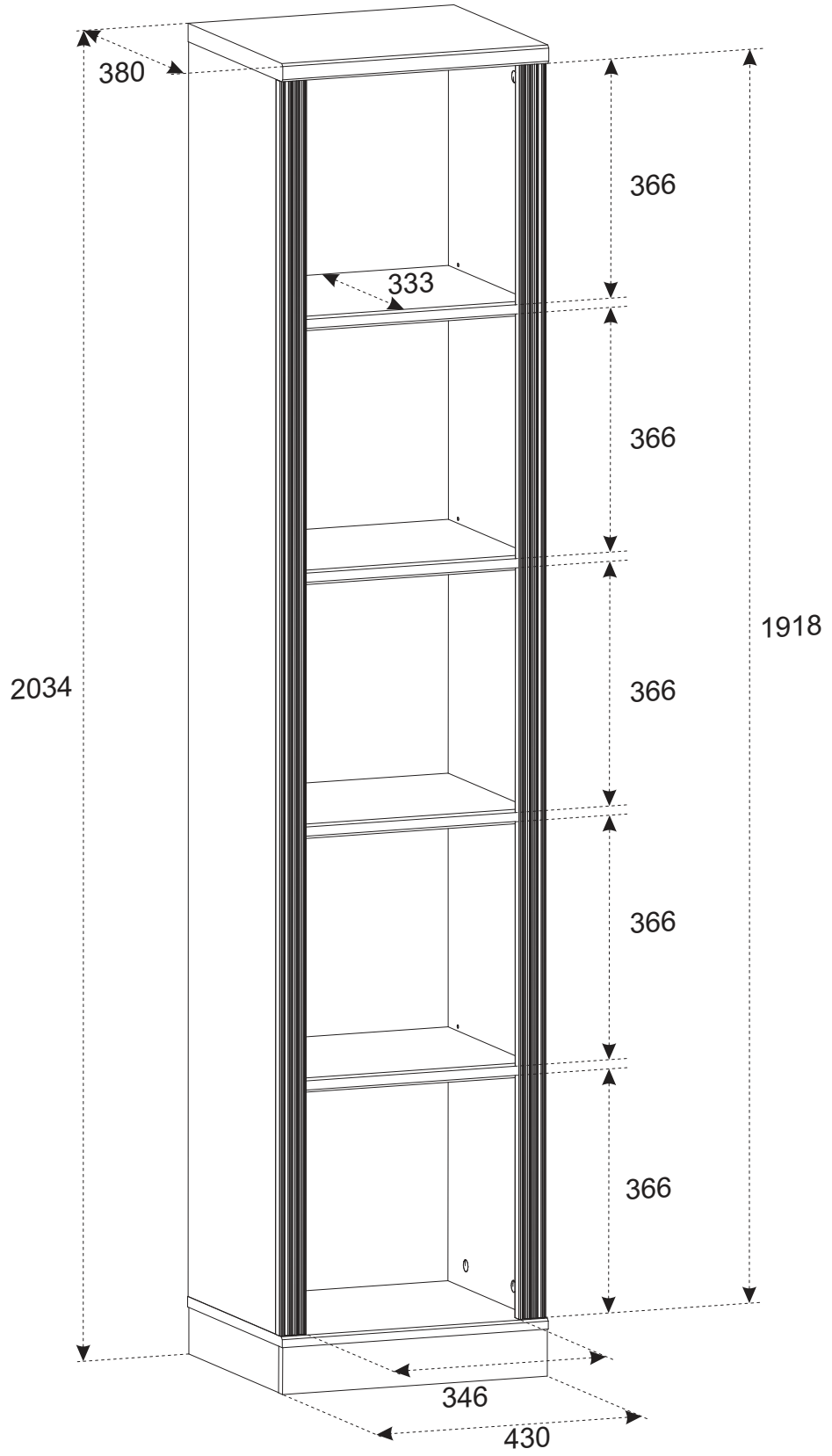

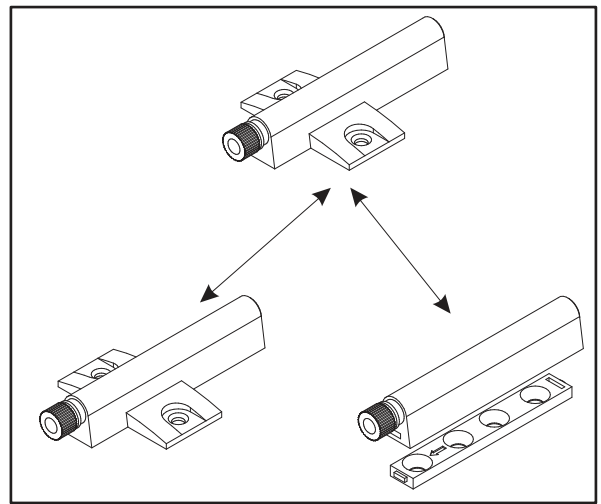
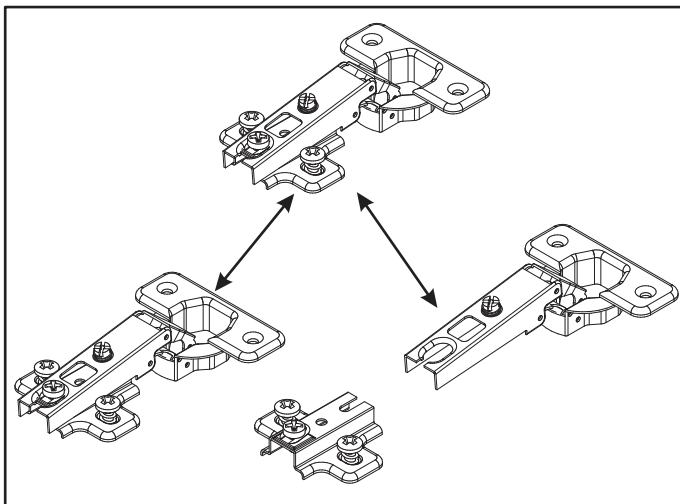
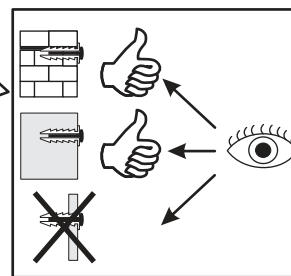
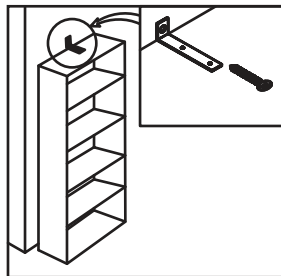
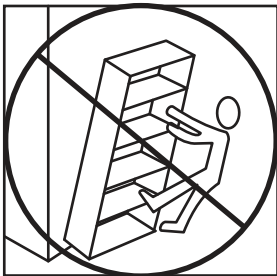
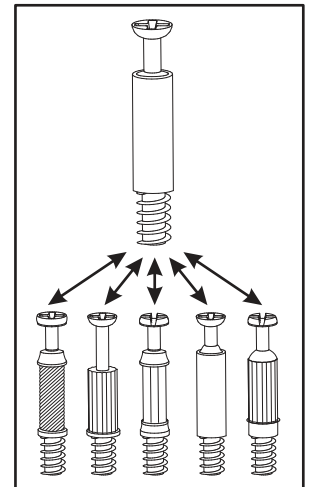
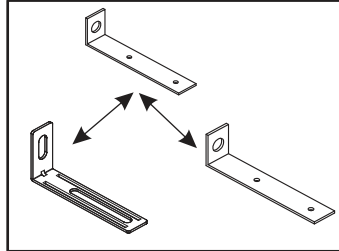
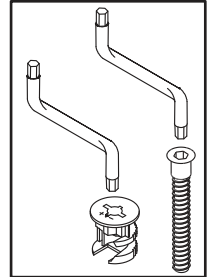
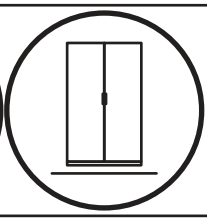
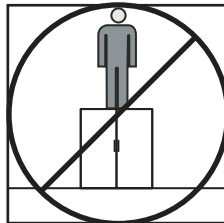
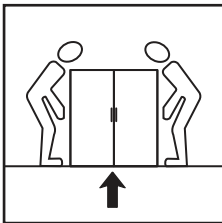
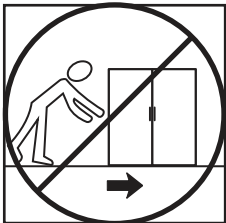
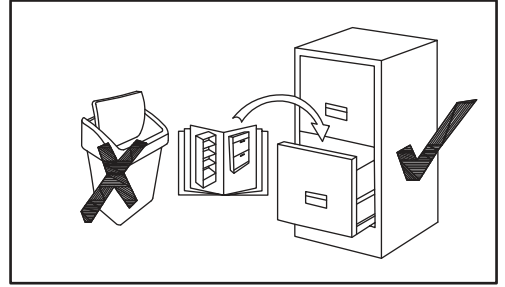
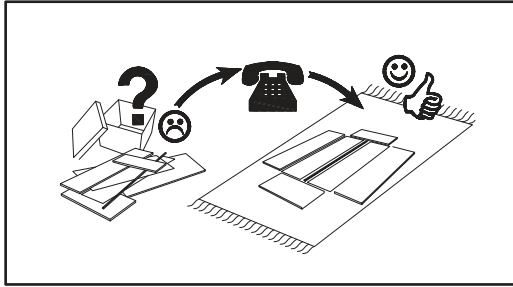
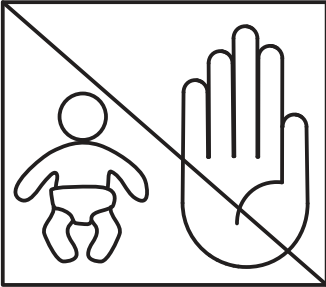
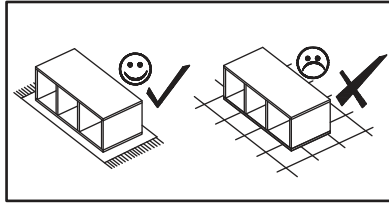
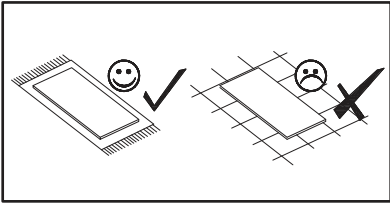

180 min

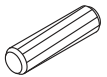
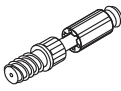



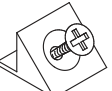

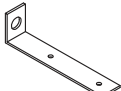
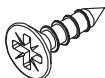
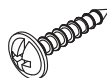
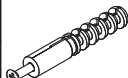
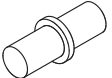
JASMIN 5K 21 -- 08

A1 x36 ø8x36		B4 x30		B5 x26 ø15x12		B16 x4 ø15x16		G5 x30		S1 x14	
I2 x4		L1 x1		D10 x2 USØ3,5x13		UP13 x2 UPØ3x16		KR1 x1		G7 x12	
G2 x1											

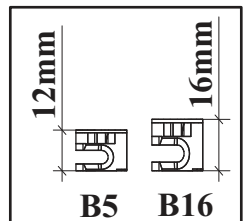

1

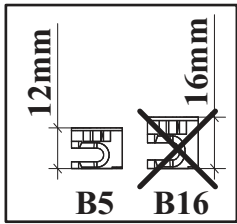

A1	
x10	ø8x36

G7	
x6	

B5	
x9	ø15x12

B4	
x2	

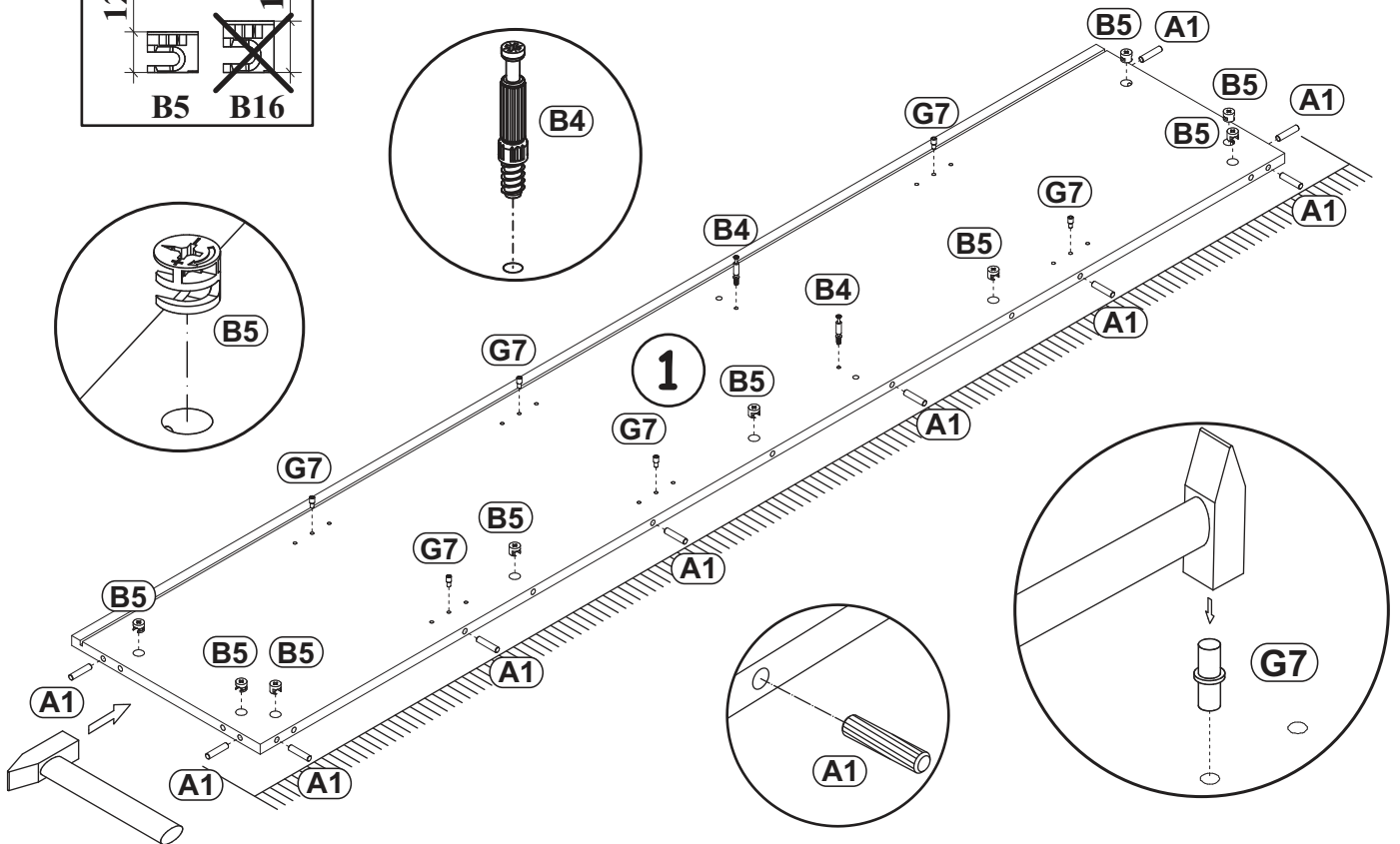

2

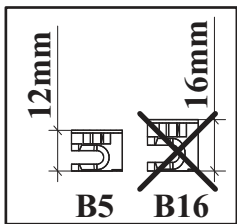

A1	
x10	ø8x36

G7	
x6	

B5	
x9	ø15x12

B4	
x2	

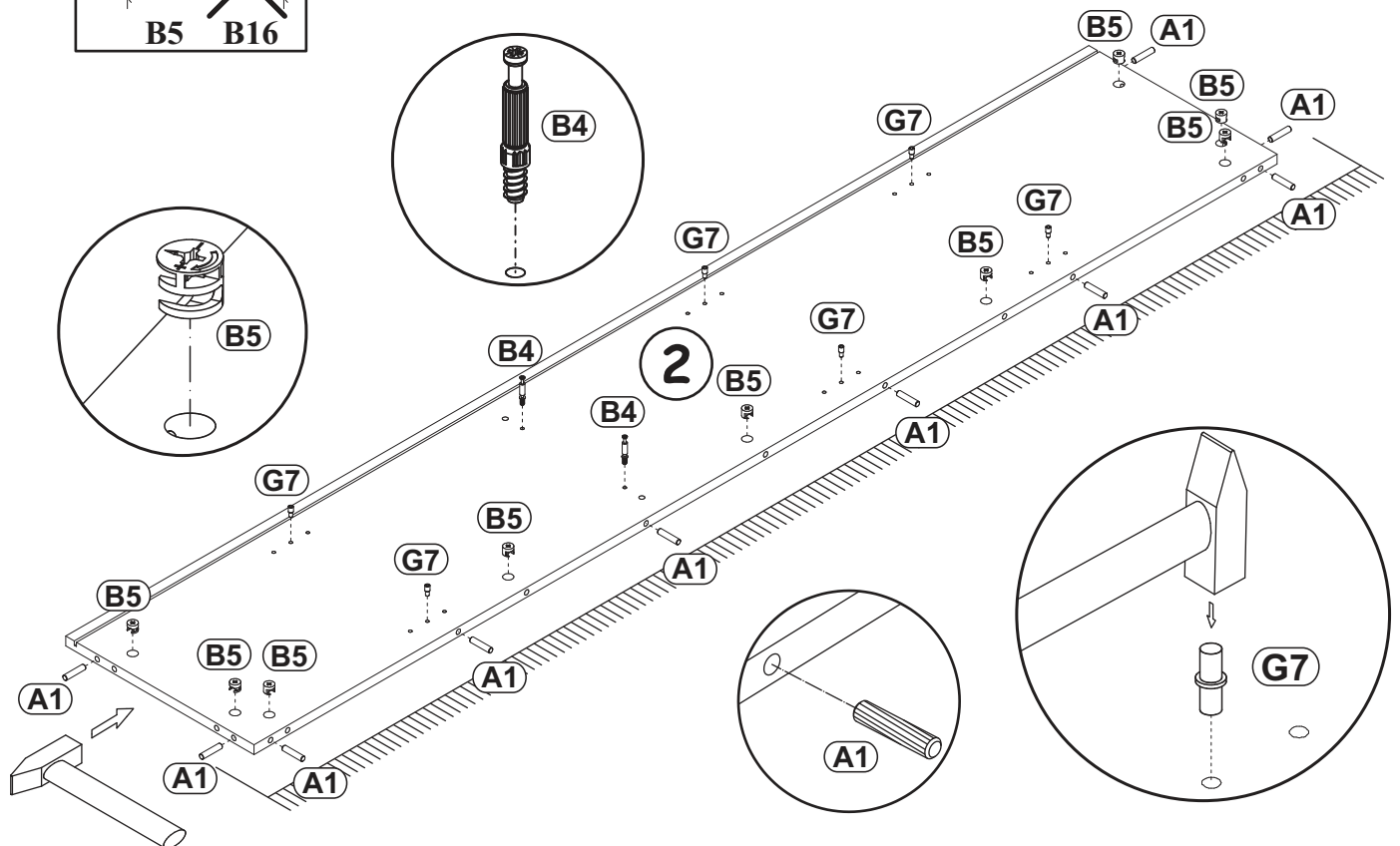

3

A1	
x4	ø8x36

B16	
x4	Ø15x16

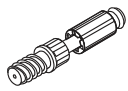
B4	
x4	

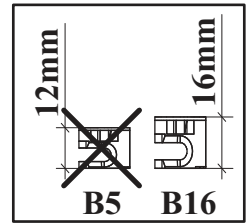
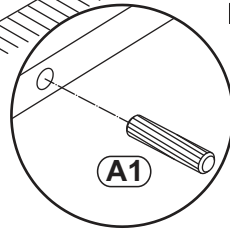
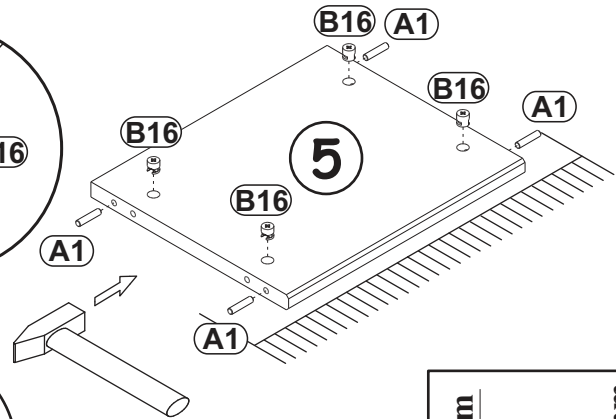
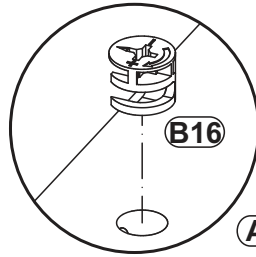
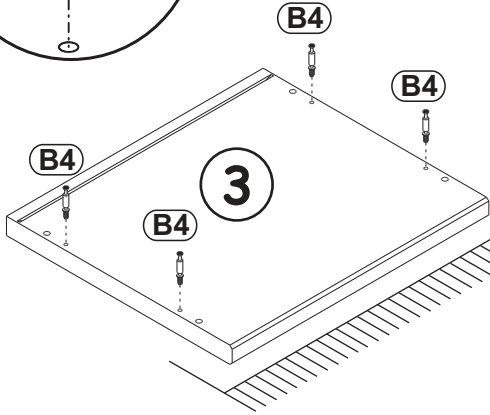
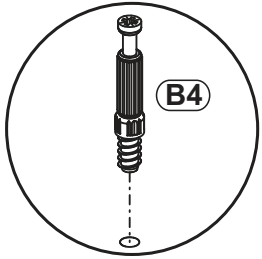

4

A1	
x12	ø8x36

B5	
x8	ø15x12

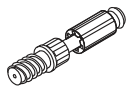
B4	
x8	

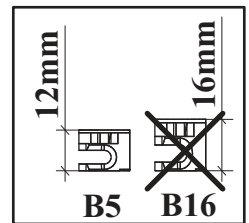
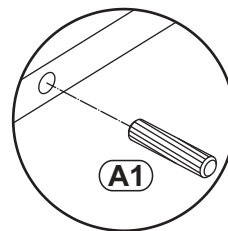
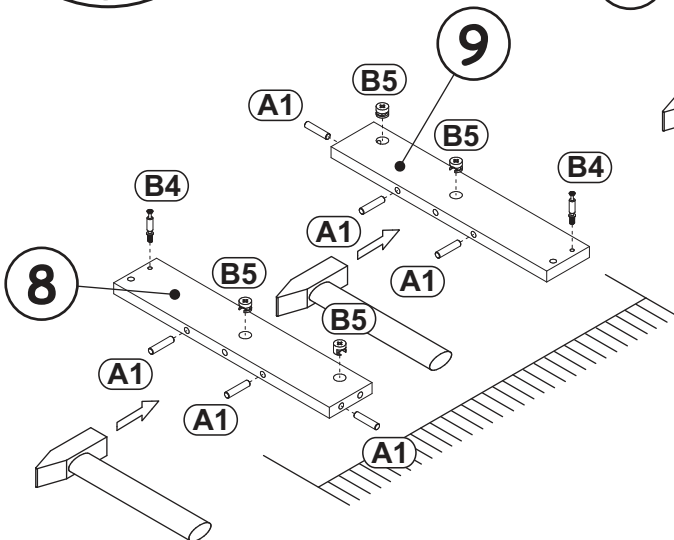
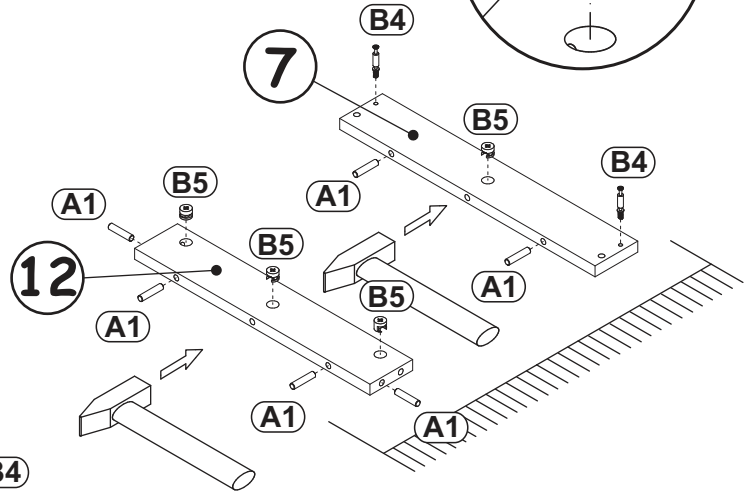
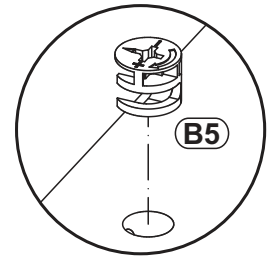
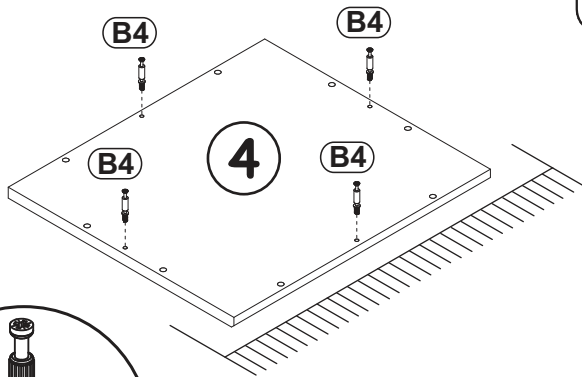
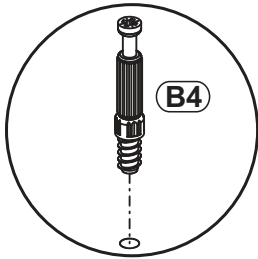

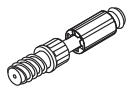
B4	
x10	

5

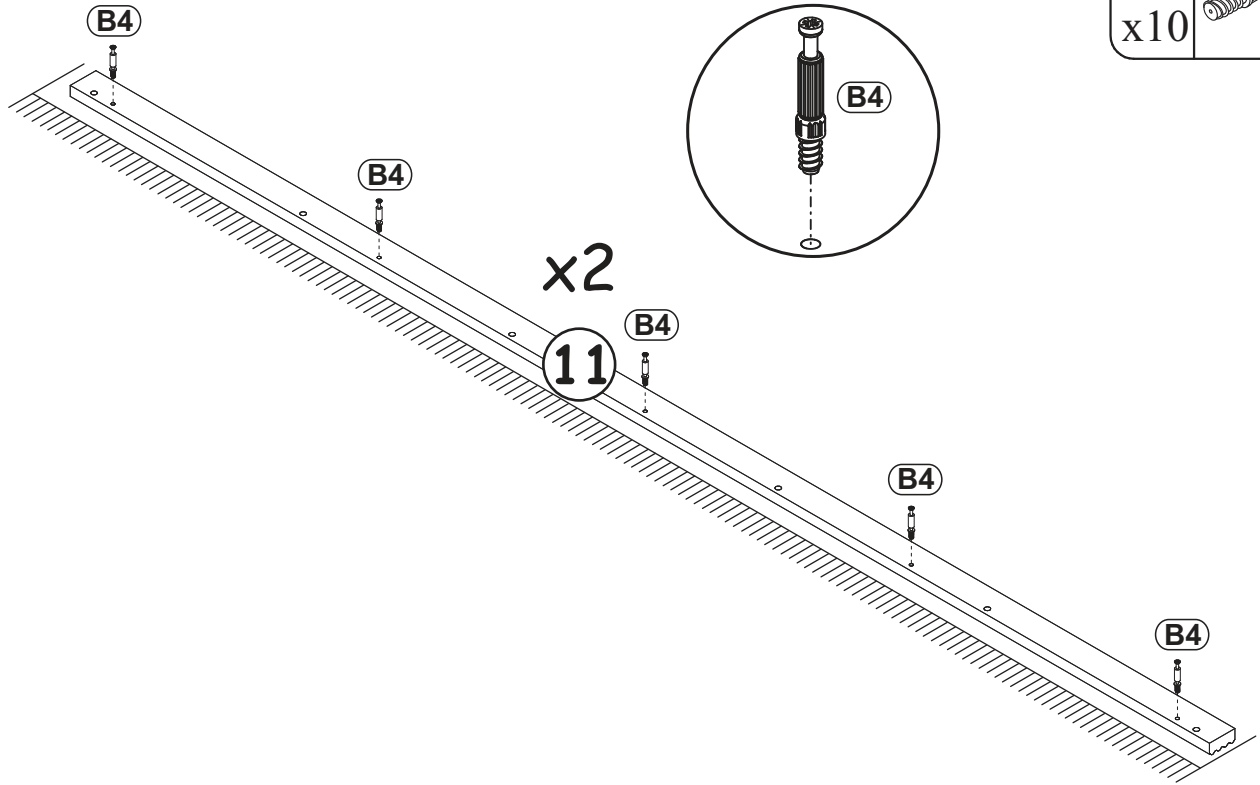

6

G5	
x5	

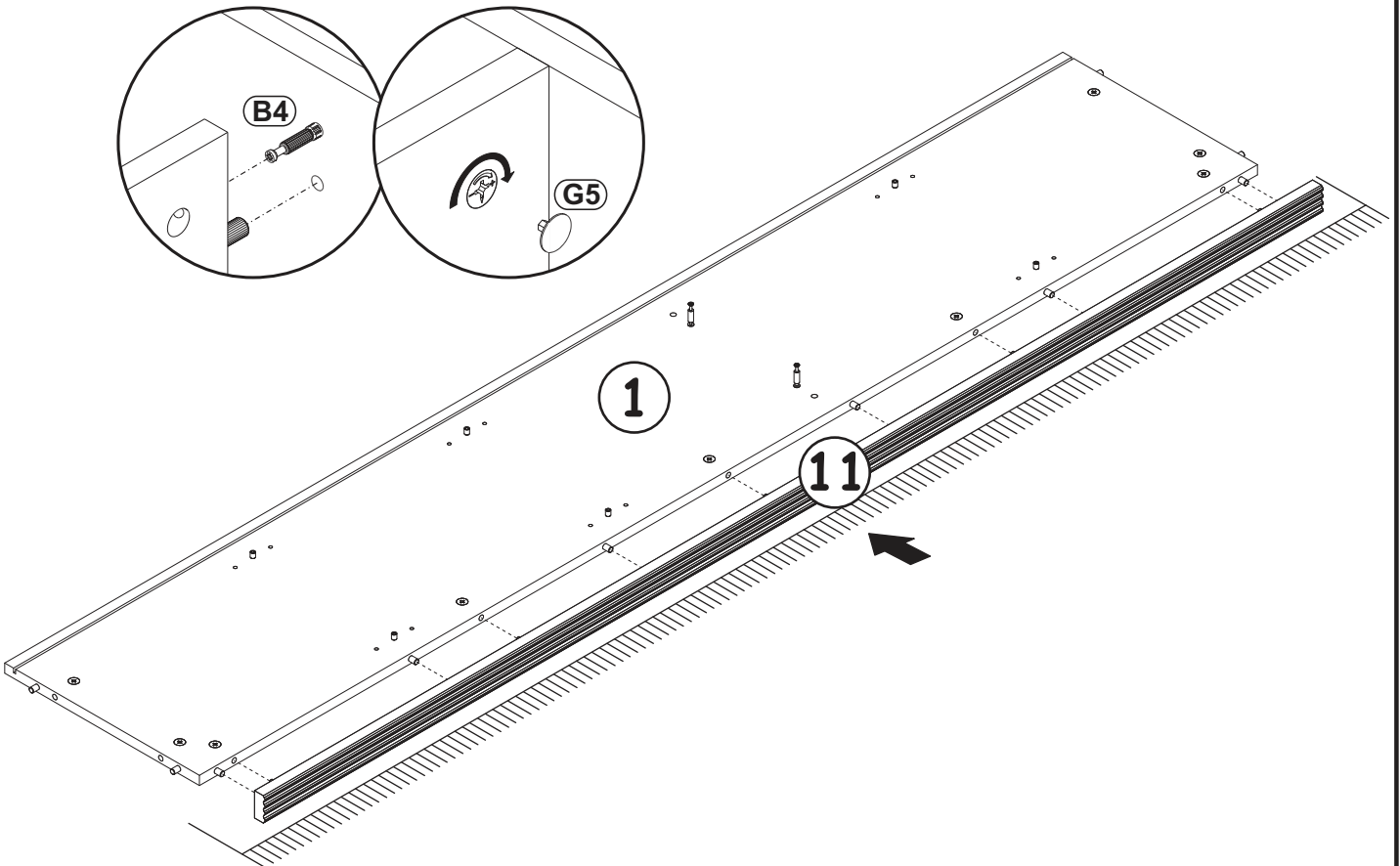

G5	
x5	

7

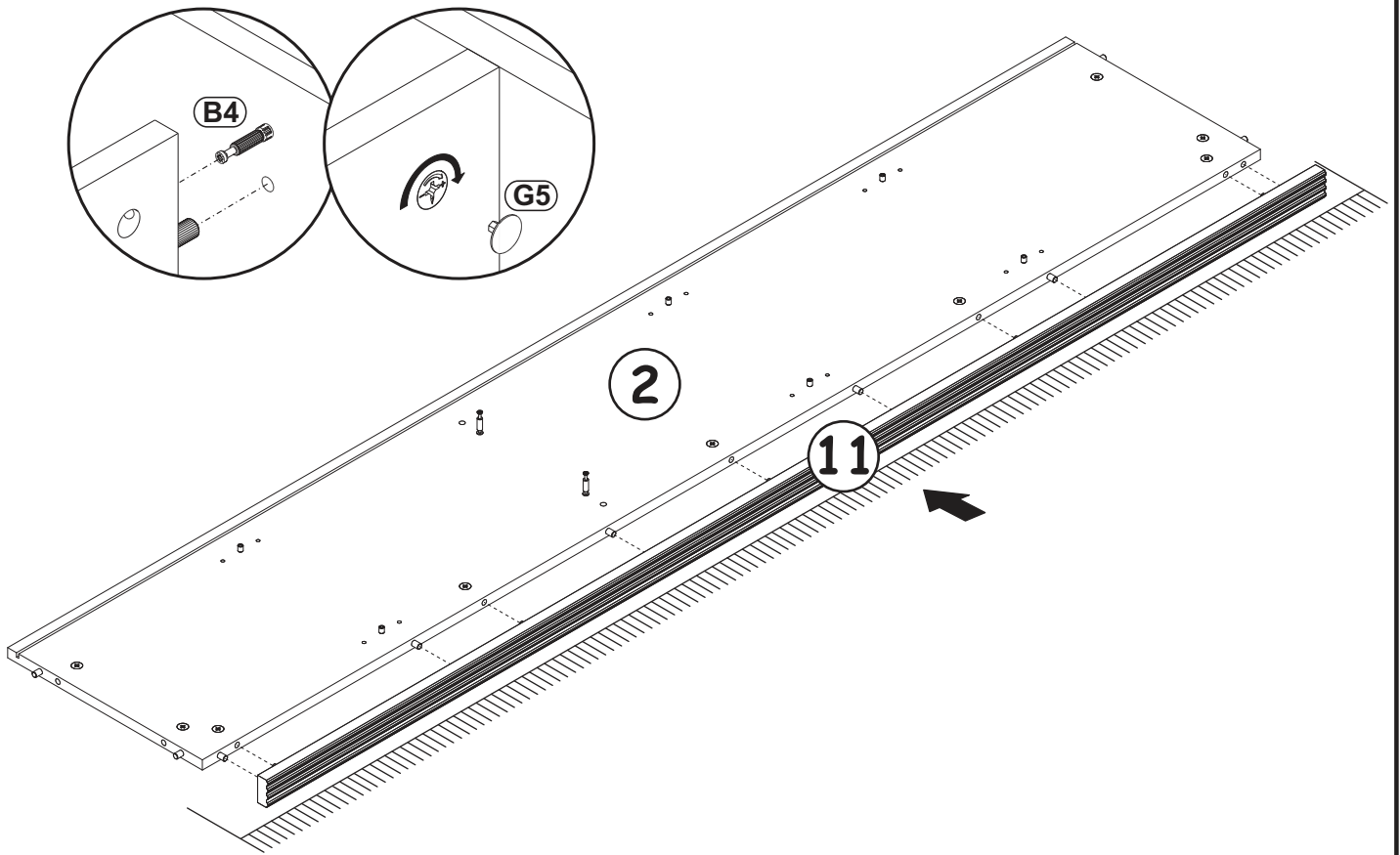

8

G5	
x2	

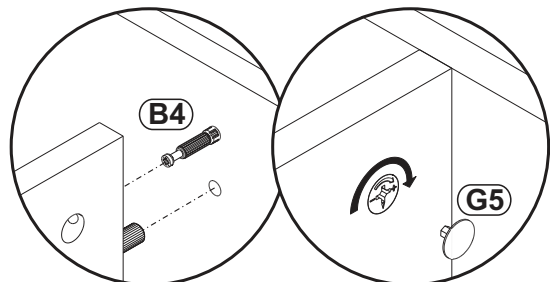
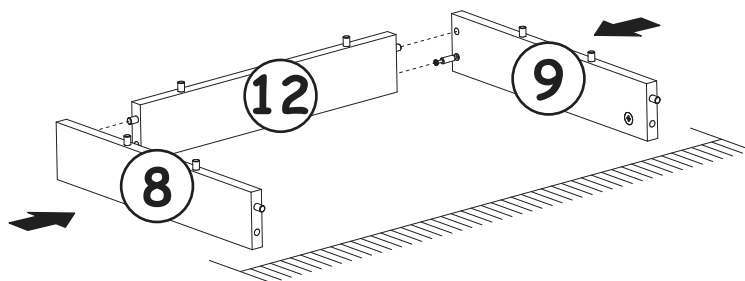



9

G5	
x2	

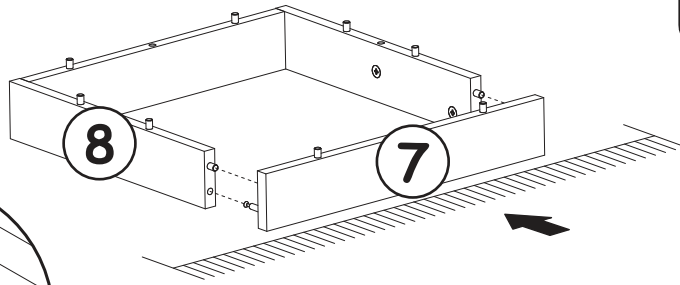
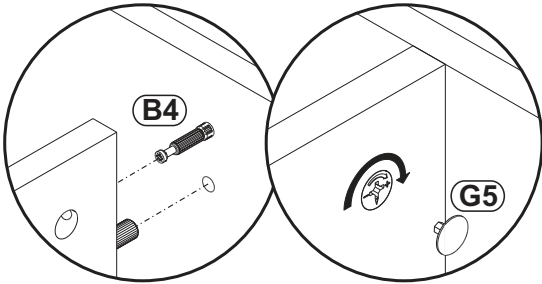

180°

10

I2		G5	
x4		x4	

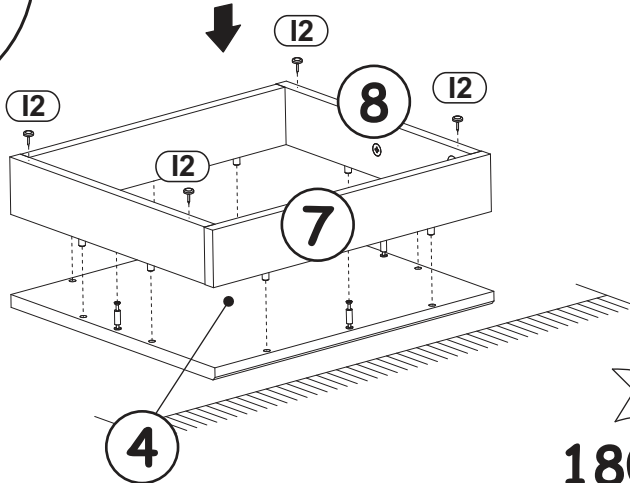
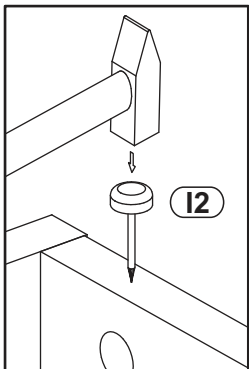
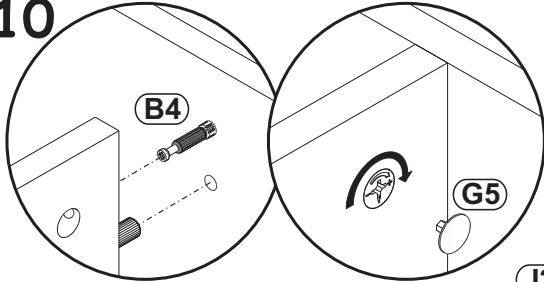

180°

11

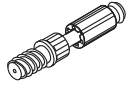
B4	
x4	

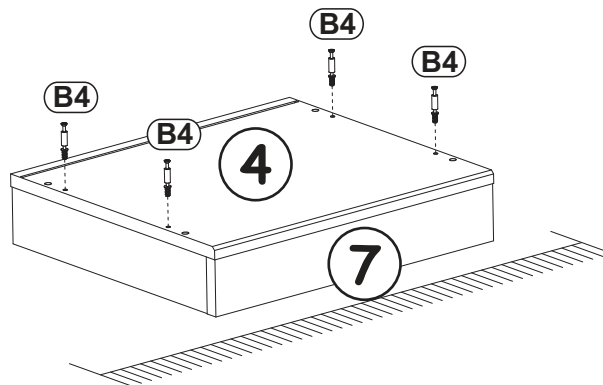
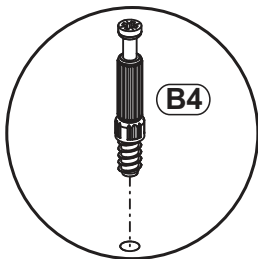

12

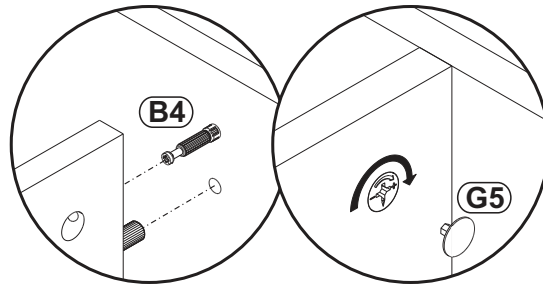

G5	
x4	

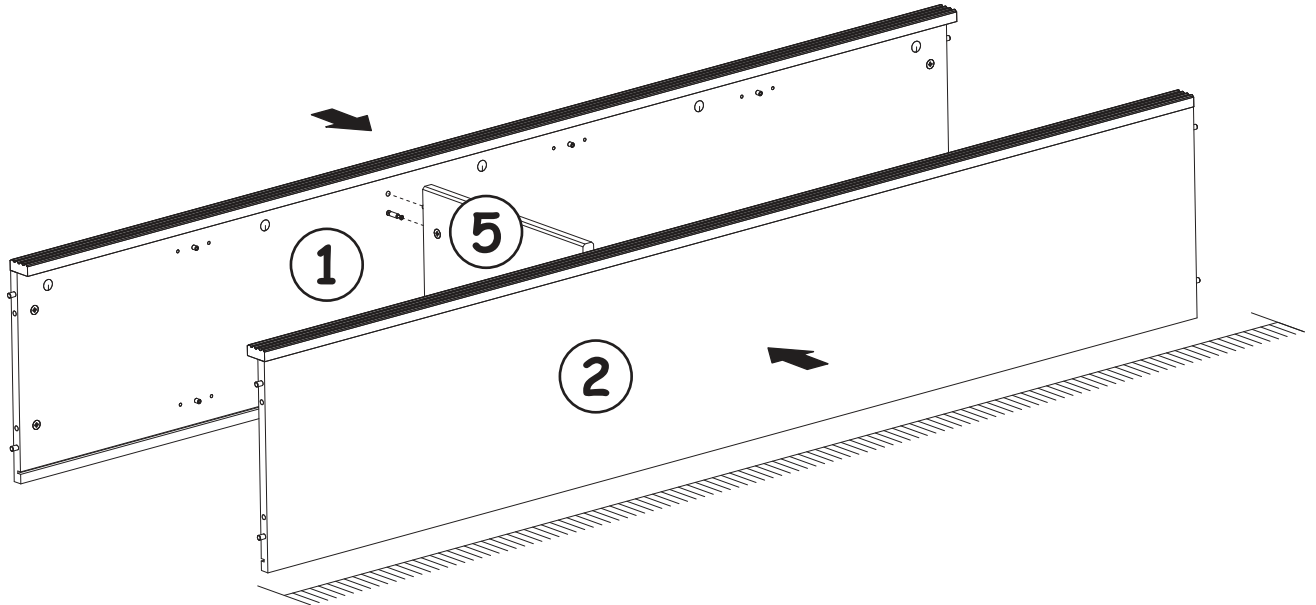

13

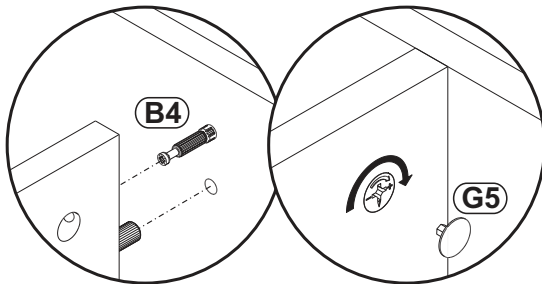

G5	
x4	

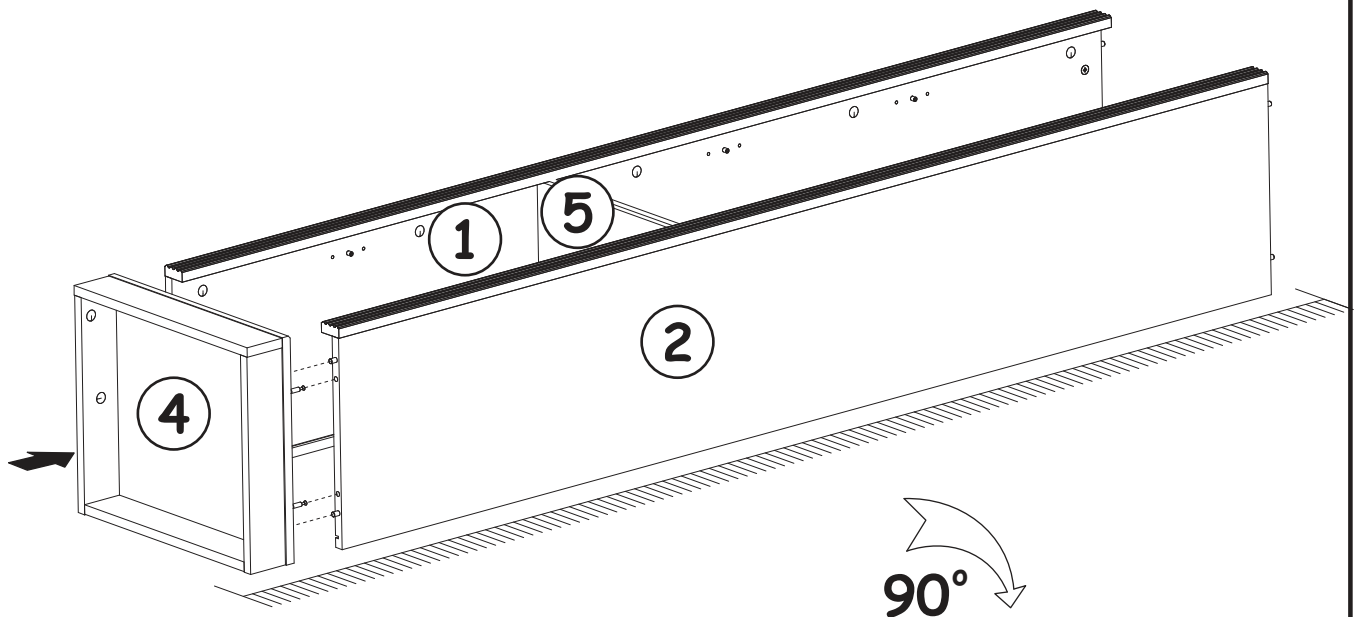

14

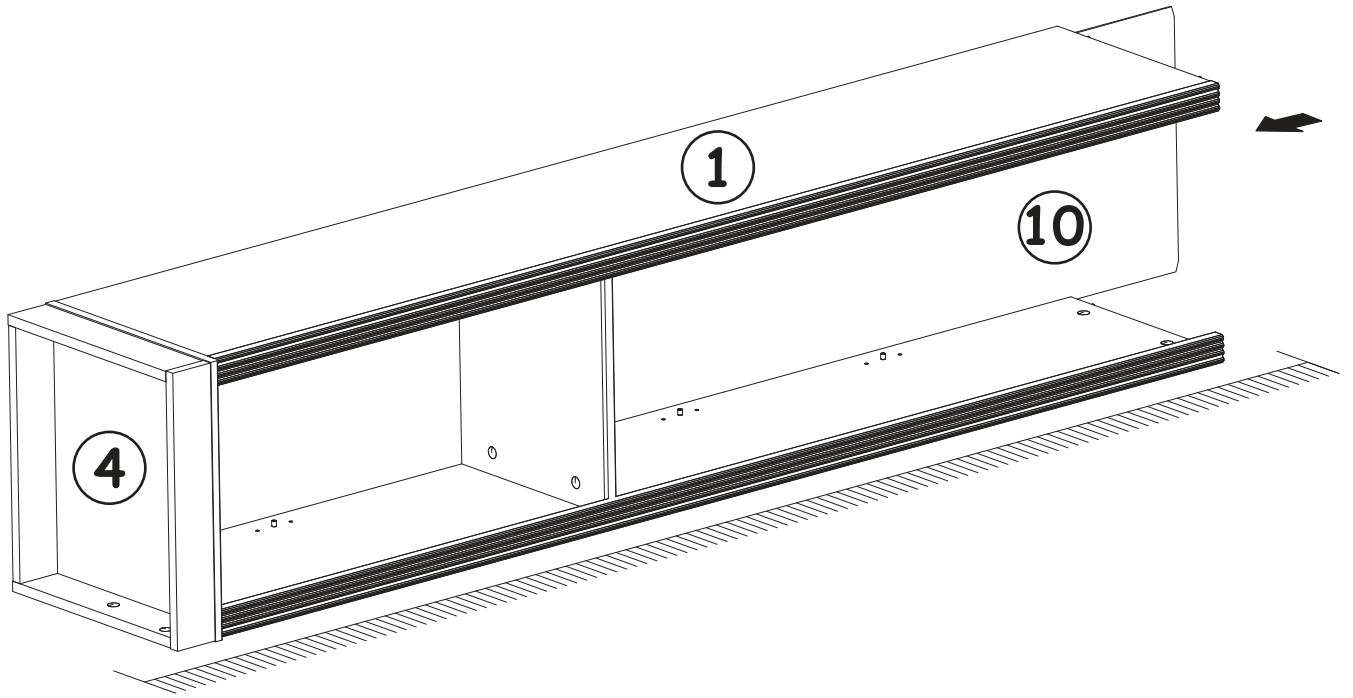

15

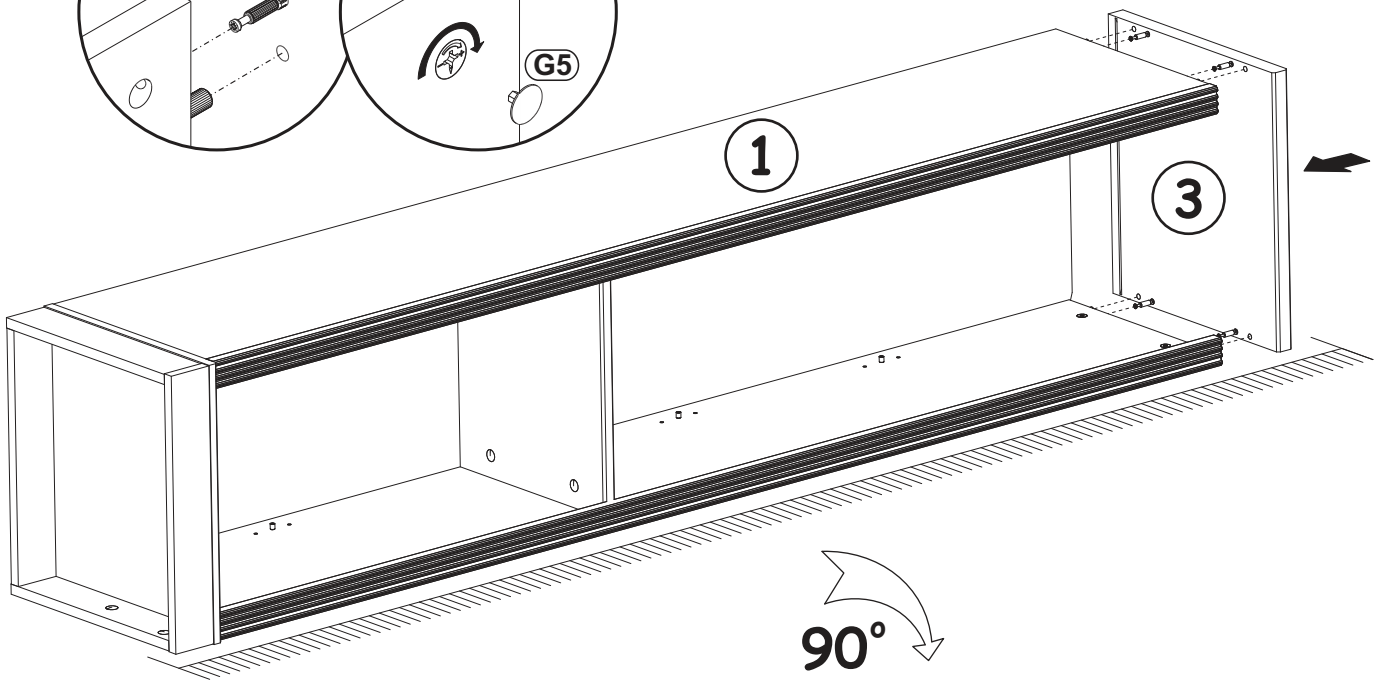
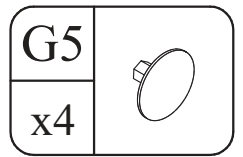
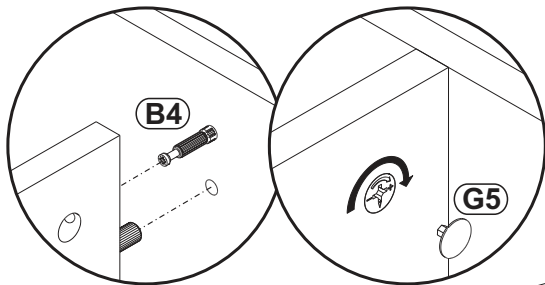

16

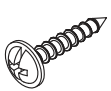
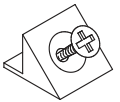

UP13		S1	
x2	UPØ3x16	x14	

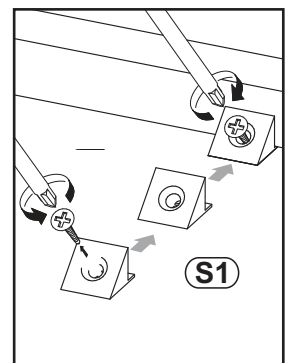
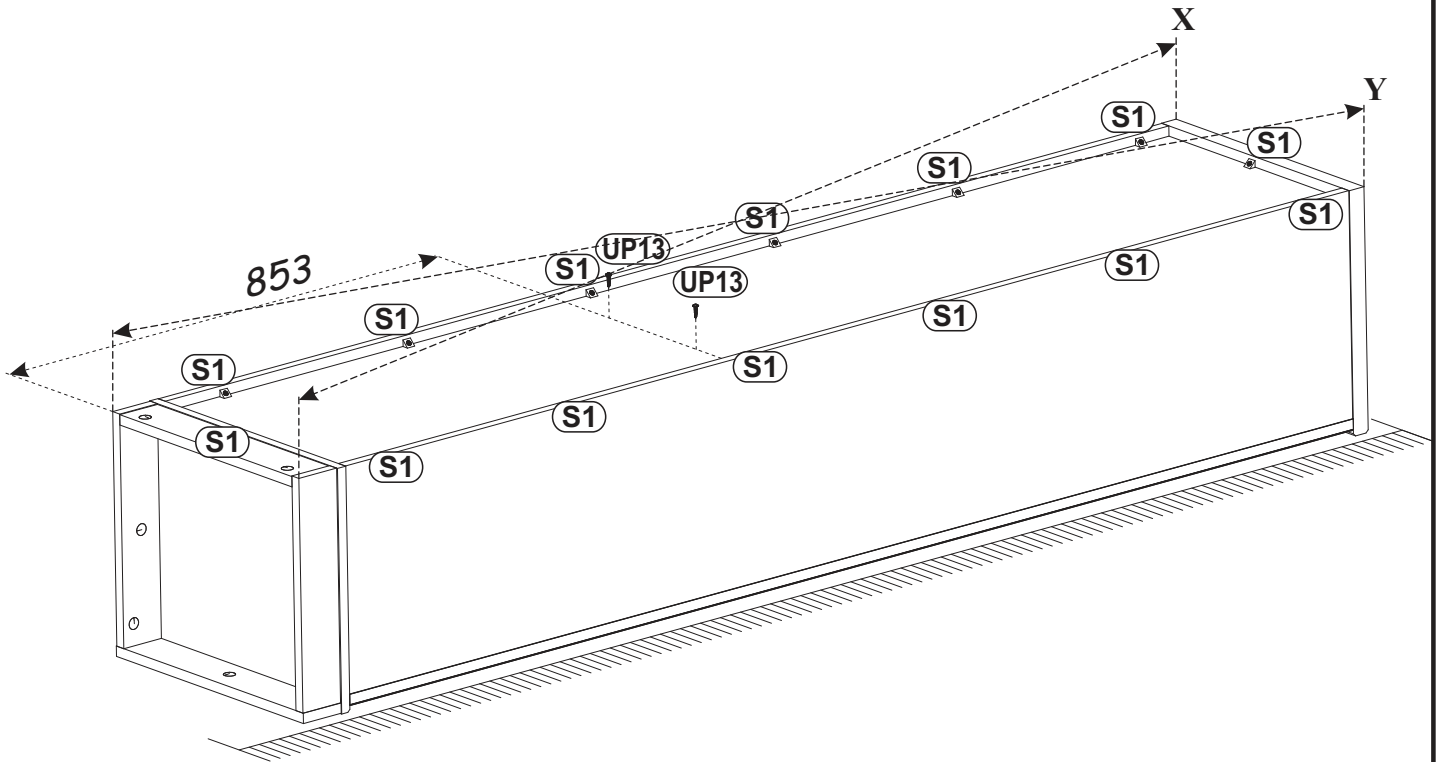
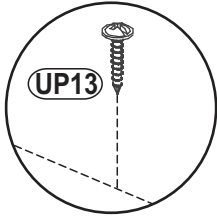

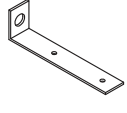
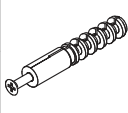
D10		L1		KR1	
x2	USØ3,5x13	x1		x1	

17

