



**D** Montageanleitung

**F** Notice de montage

**NL** Handleiding voor de montage

**CZ** Monzážní návod

**HU** Szerelési útmutató

**TR** Montaj talimatı

**GB** Assembly instructions

**I** Istruzione di montaggio

**PL** Instrukcja montaży

**SK** Návod na montáž

**RO** Instrucțiuni de montaj

**RU** ИНСТРУКЦИЯ ПО МОНТАЖУ

Art. Nr. 1040

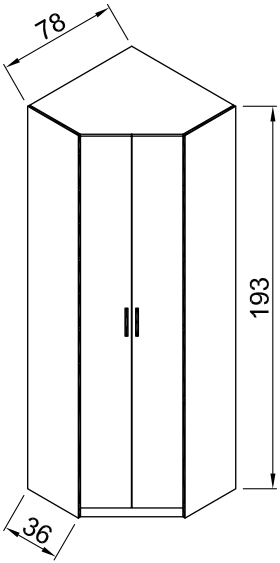

Art. Nr. 1040

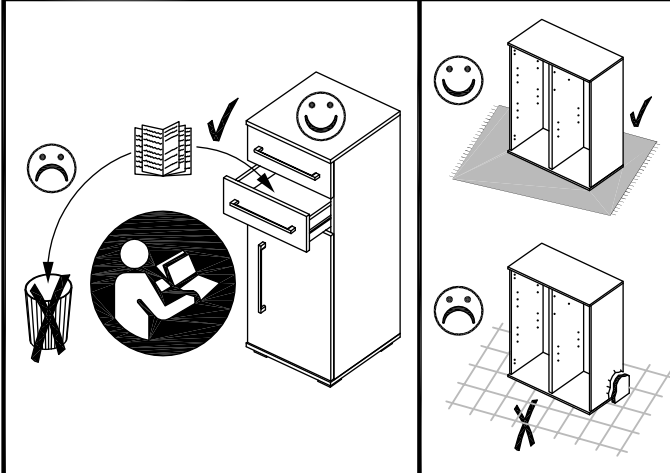
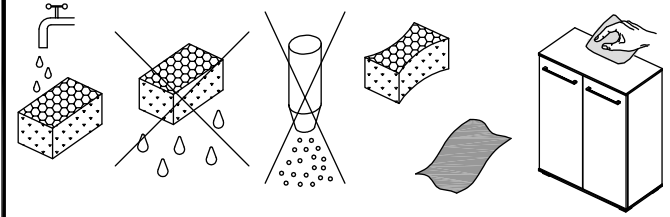
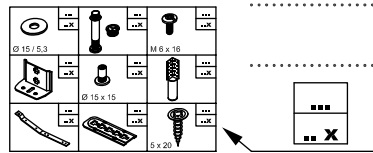
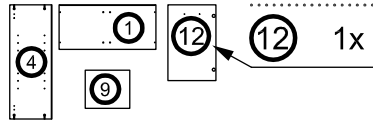

	<b>62</b> <b>12x</b>		<b>72</b> <b>7x</b>		<b>108</b> <b>6x</b>
3,5 x 13		4x13			
	<b>142</b> <b>8x</b>		<b>143</b> <b>8x</b>		<b>222</b> <b>12x</b>
Ø 15 x 11,5		6 x 44		4,5 x 55	
	<b>296</b> <b>2x</b>		<b>364</b> <b>6x</b>		<b>903</b> <b>12x</b>
521 mm					
	<b>905</b> <b>12x</b>		<b>908</b> <b>4x</b>		<b>916</b> <b>28x</b>
Ø 12 / 2,5					
	<b>921</b> <b>8x</b>		<b>927</b> <b>8x</b>		<b>928</b> <b>12x</b>
		6,3 x 11		4 x 15	
	<b>941</b> <b>4x</b>		<b>991</b> <b>2x</b>		

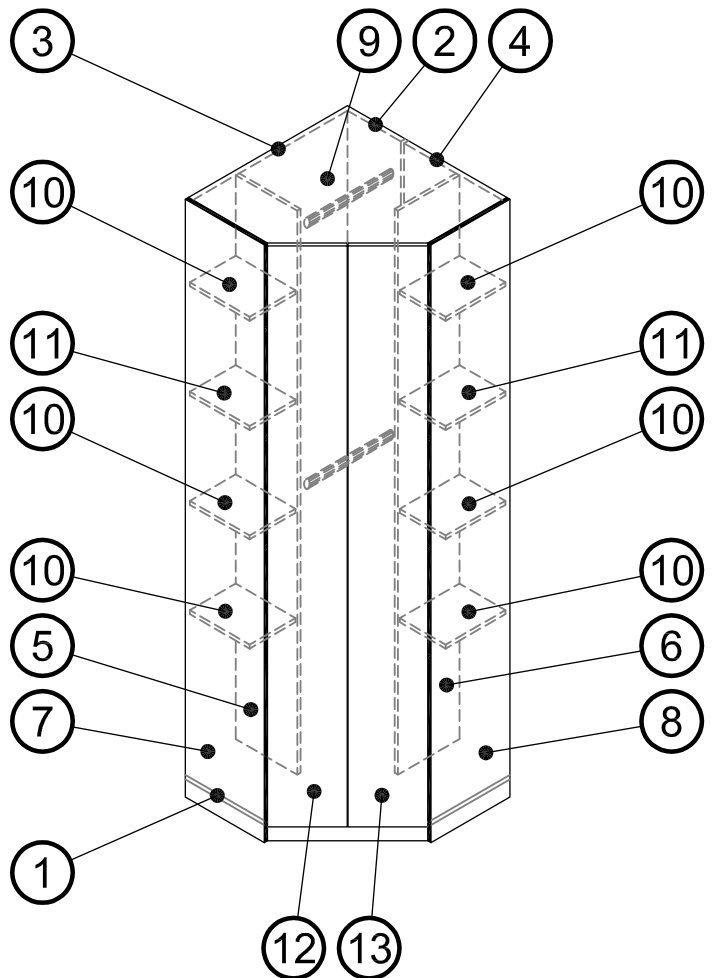

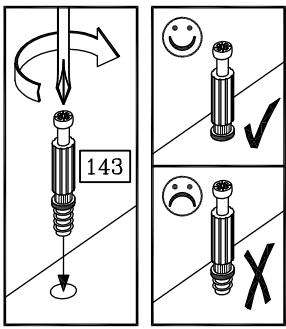

Rückwand

Linke Mittelwand

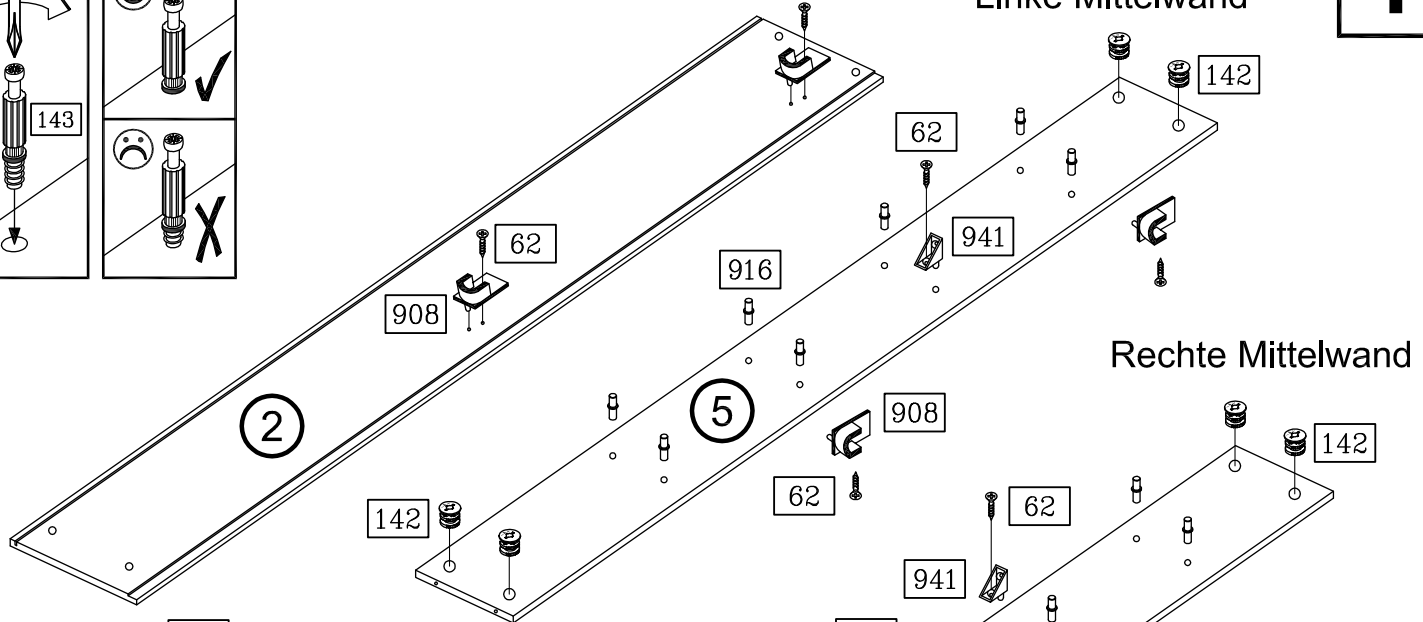

Rechte Mittelwand

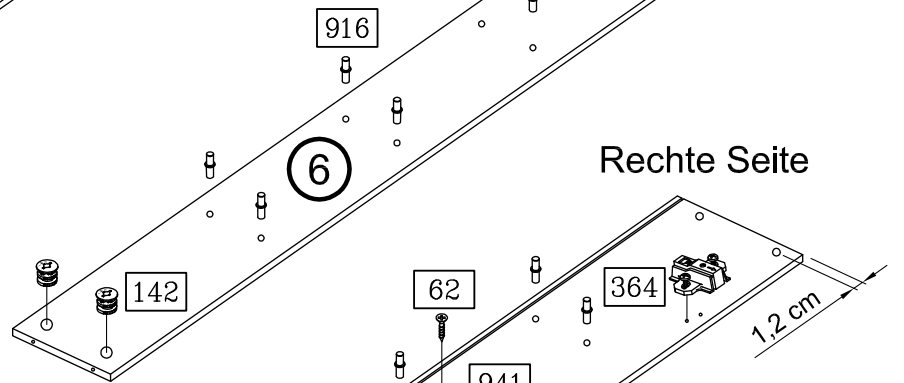
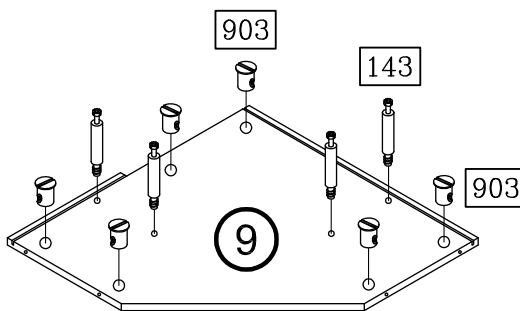
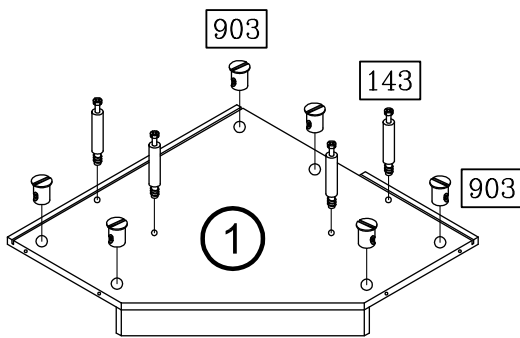

Rechte Seite

Linke Seite

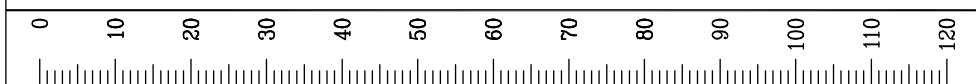
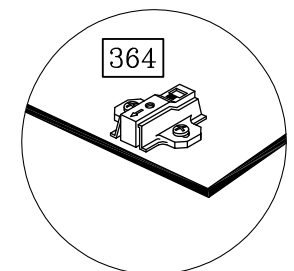
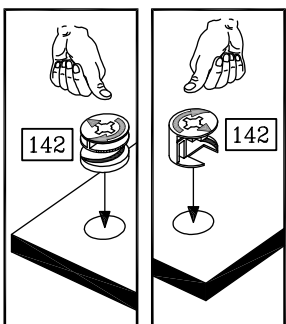
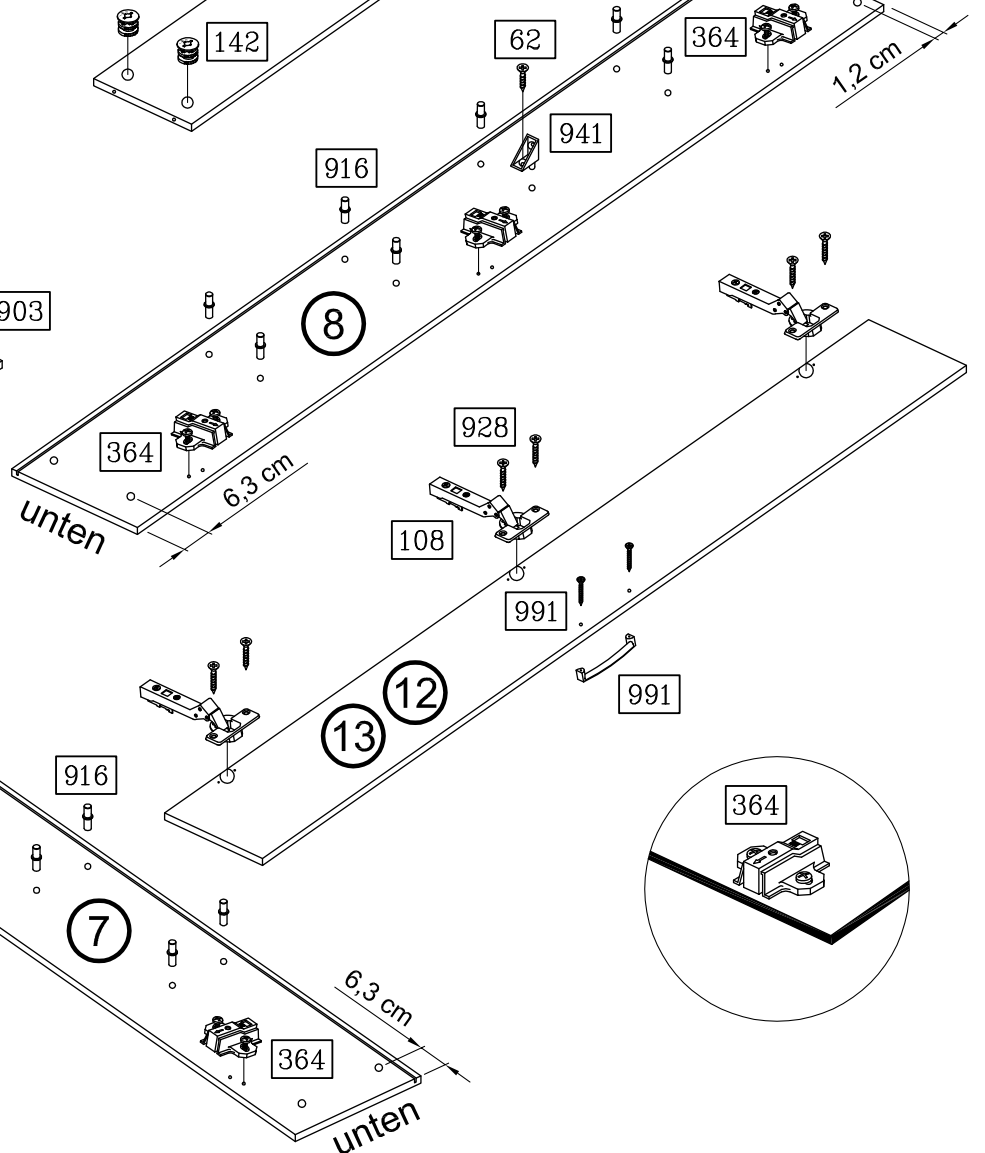

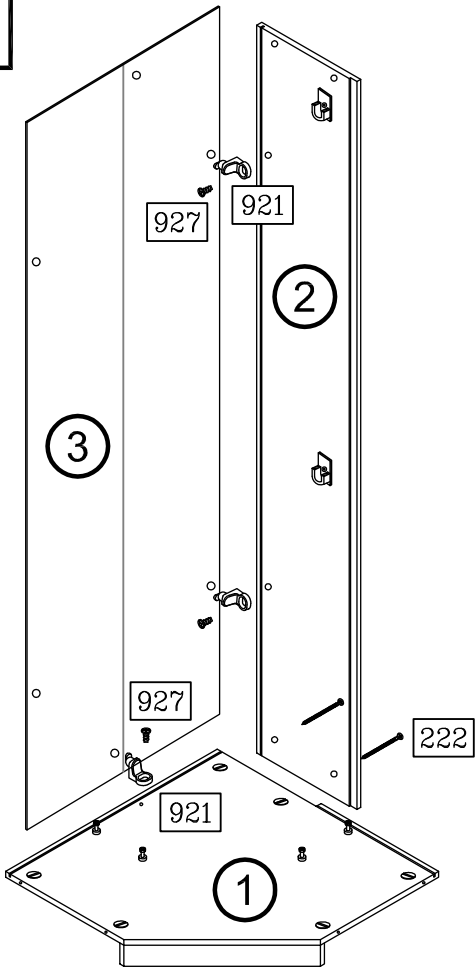
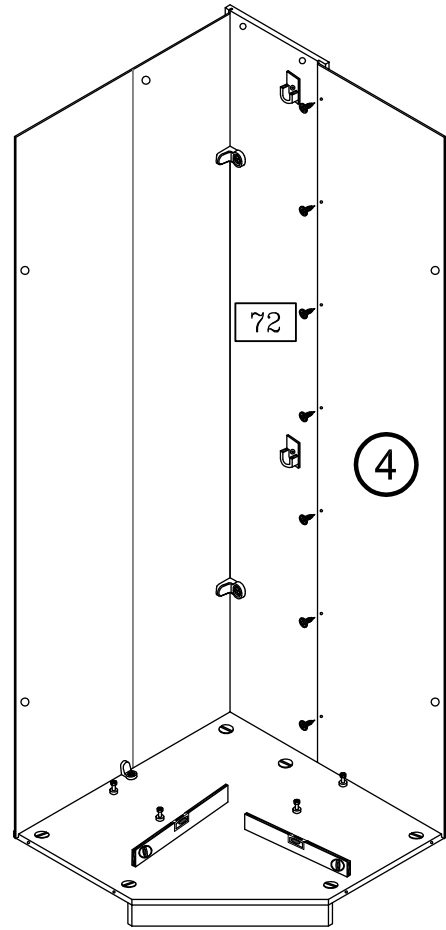
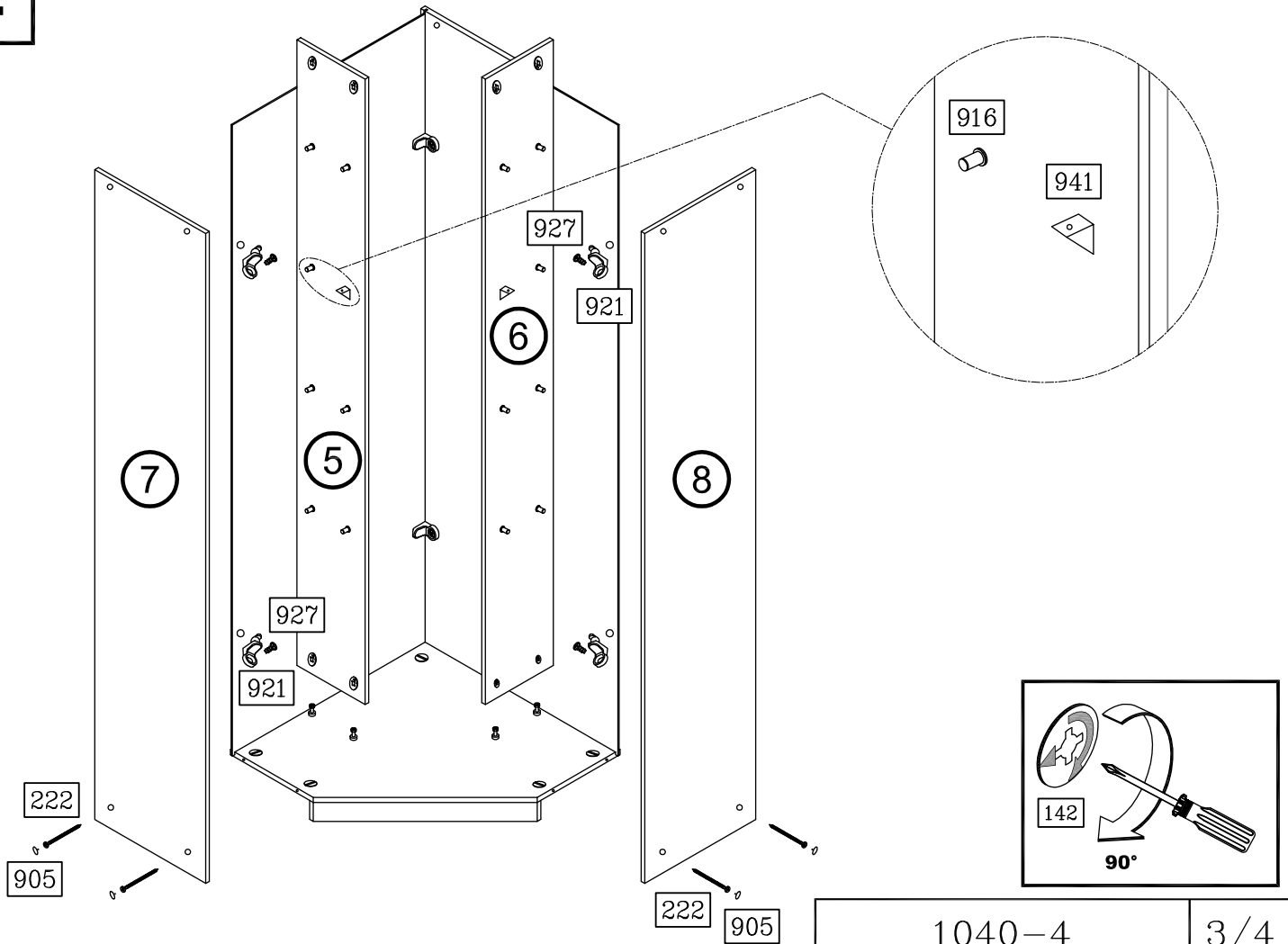
**2****3****4**

1040-4

3/4

5

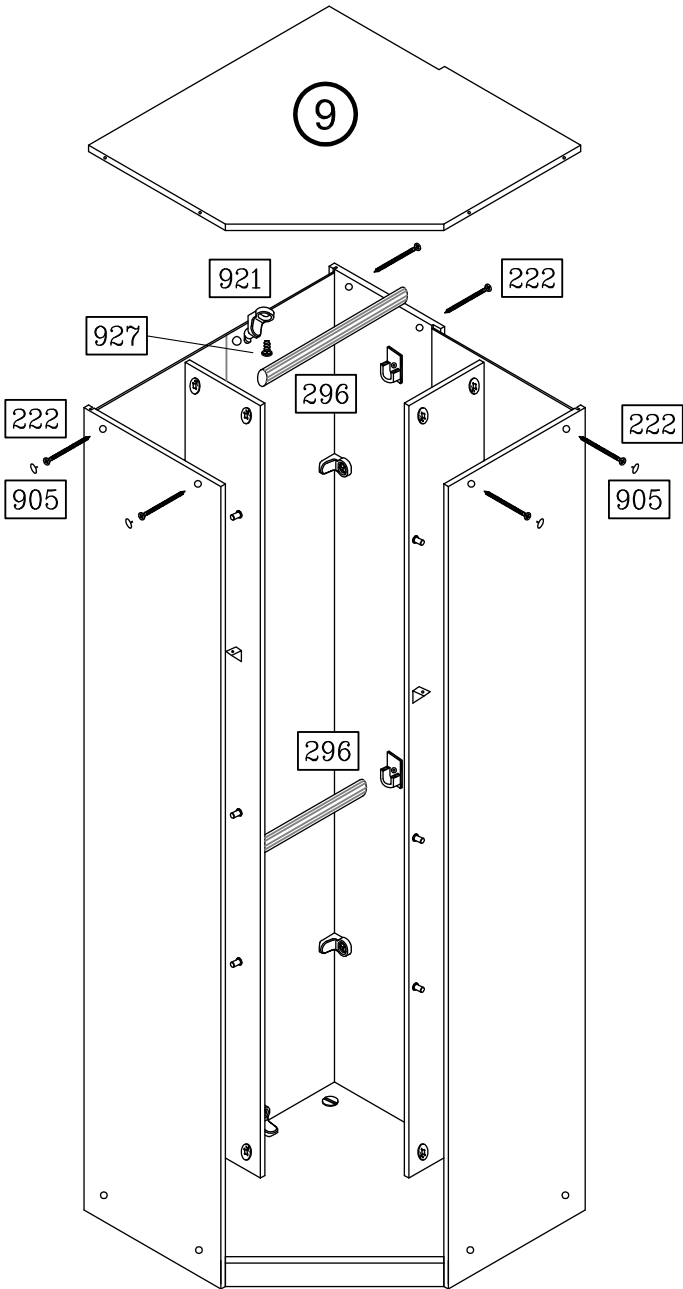

6

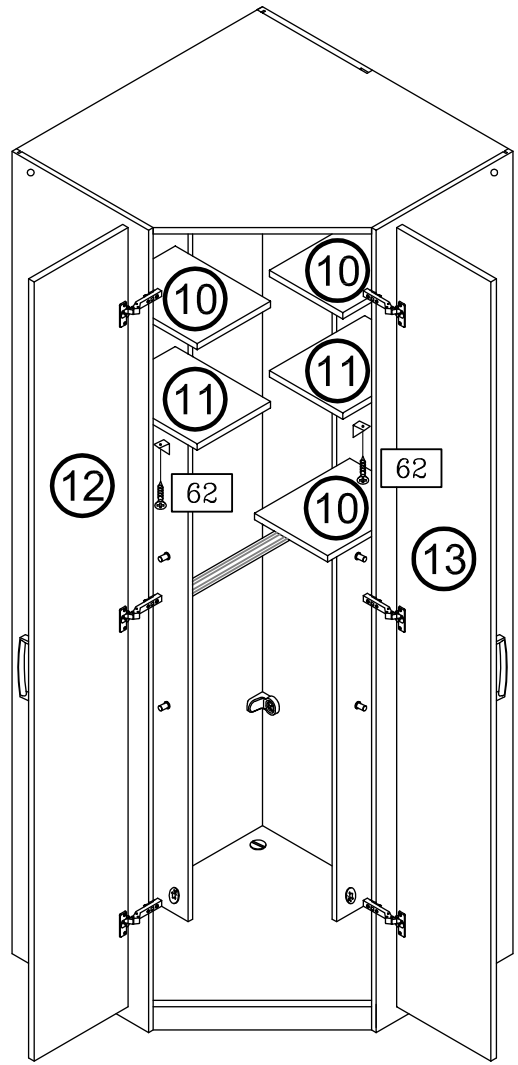

1.

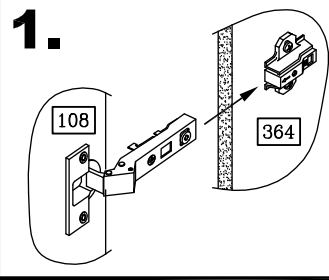

2.

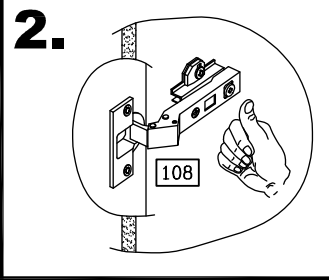

7

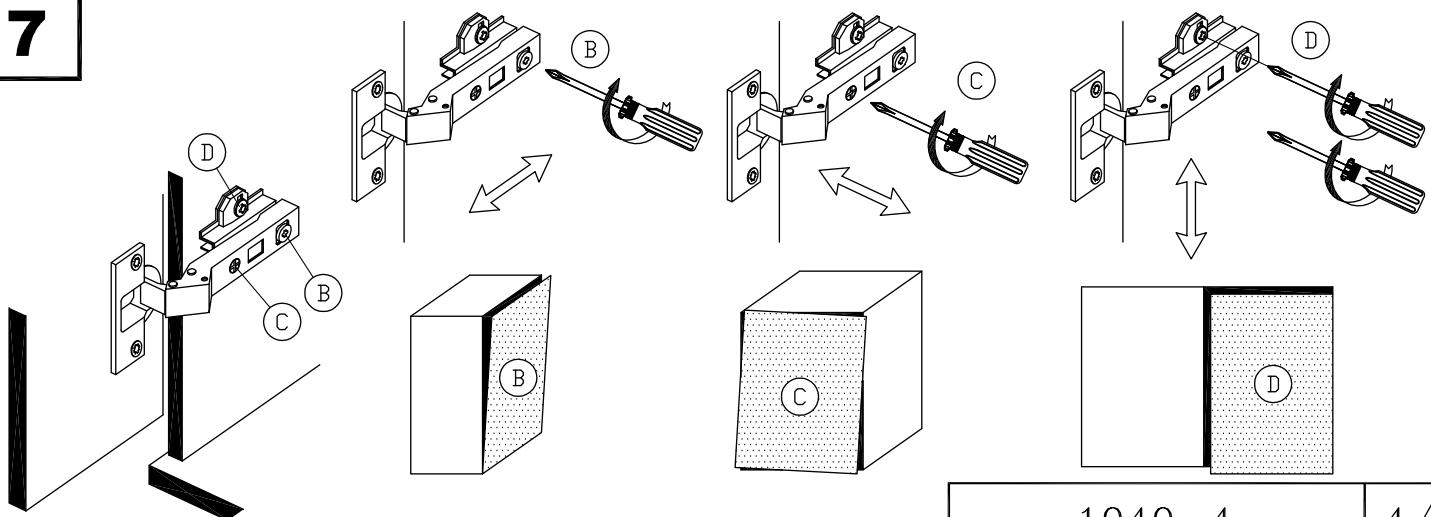



**D** Montageanleitung

**F** Notice de montage

**NL** Handleiding voor de montage

**CZ** Monzážní návod

**HU** Szerelési útmutató

**TR** Montaj talimatı

**GB** Assembly instructions

**I** Istruzione di montaggio

**PL** Instrukcja montaży

**SK** Návod na montáž

**RO** Instrucțiuni de montaj

**RU** ИНСТРУКЦИЯ ПО МОНТАЖУ

Art. Nr.

ZB150-LED-OK

LED -  
Glaskranzleiste

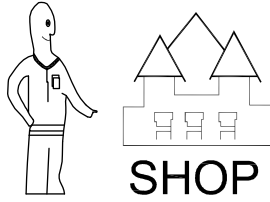

Art. Nr. ZB150-LED-OK

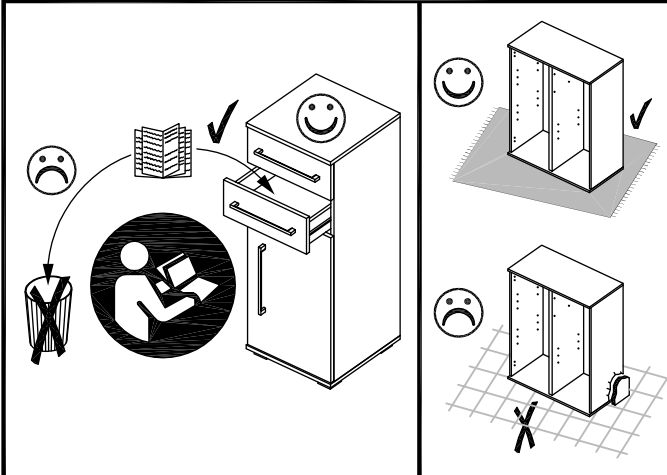
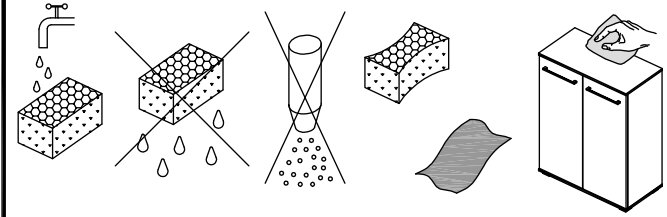
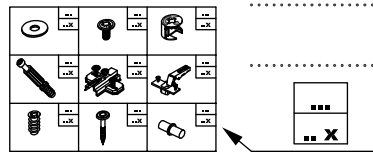
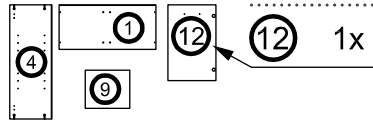

**1**

Glasplatte - Glass plate

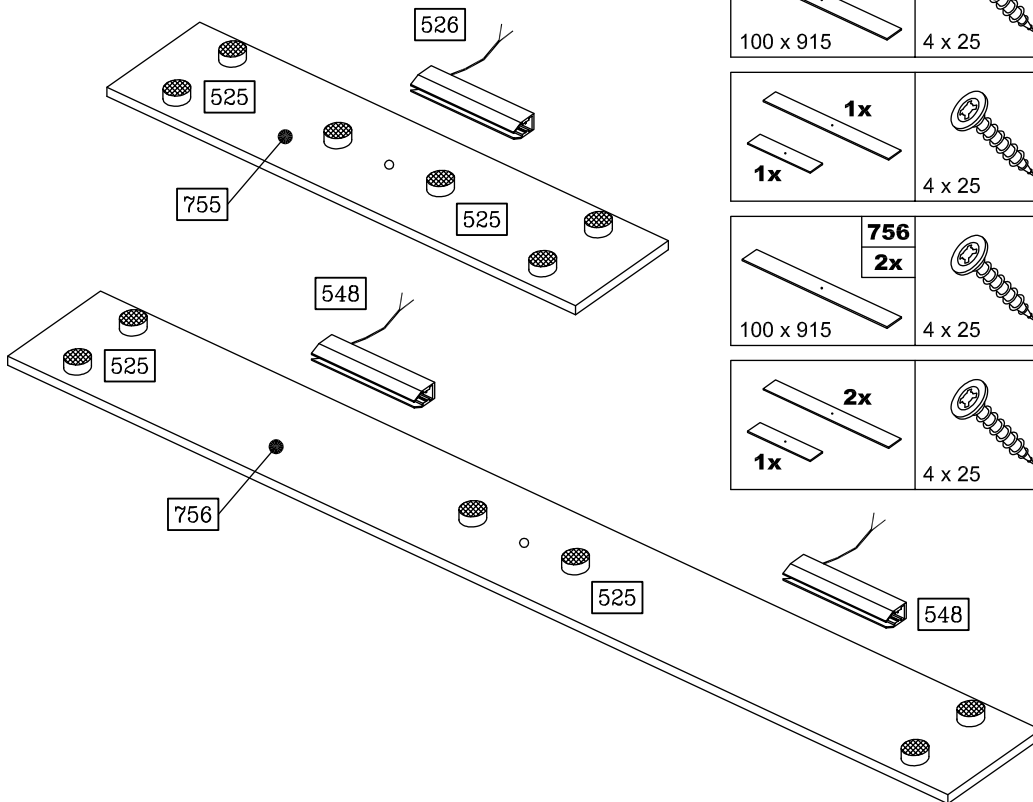
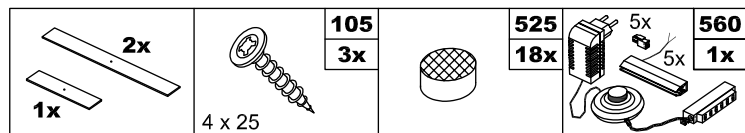
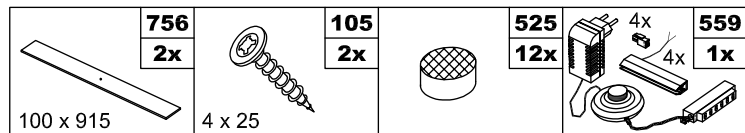
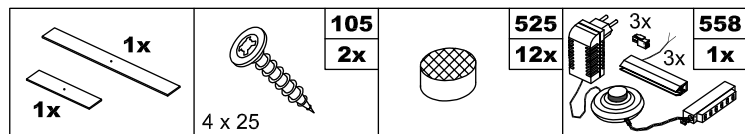
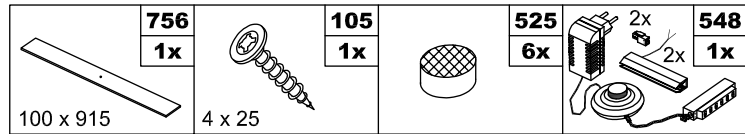
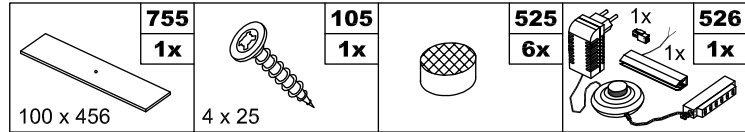
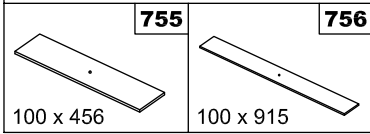

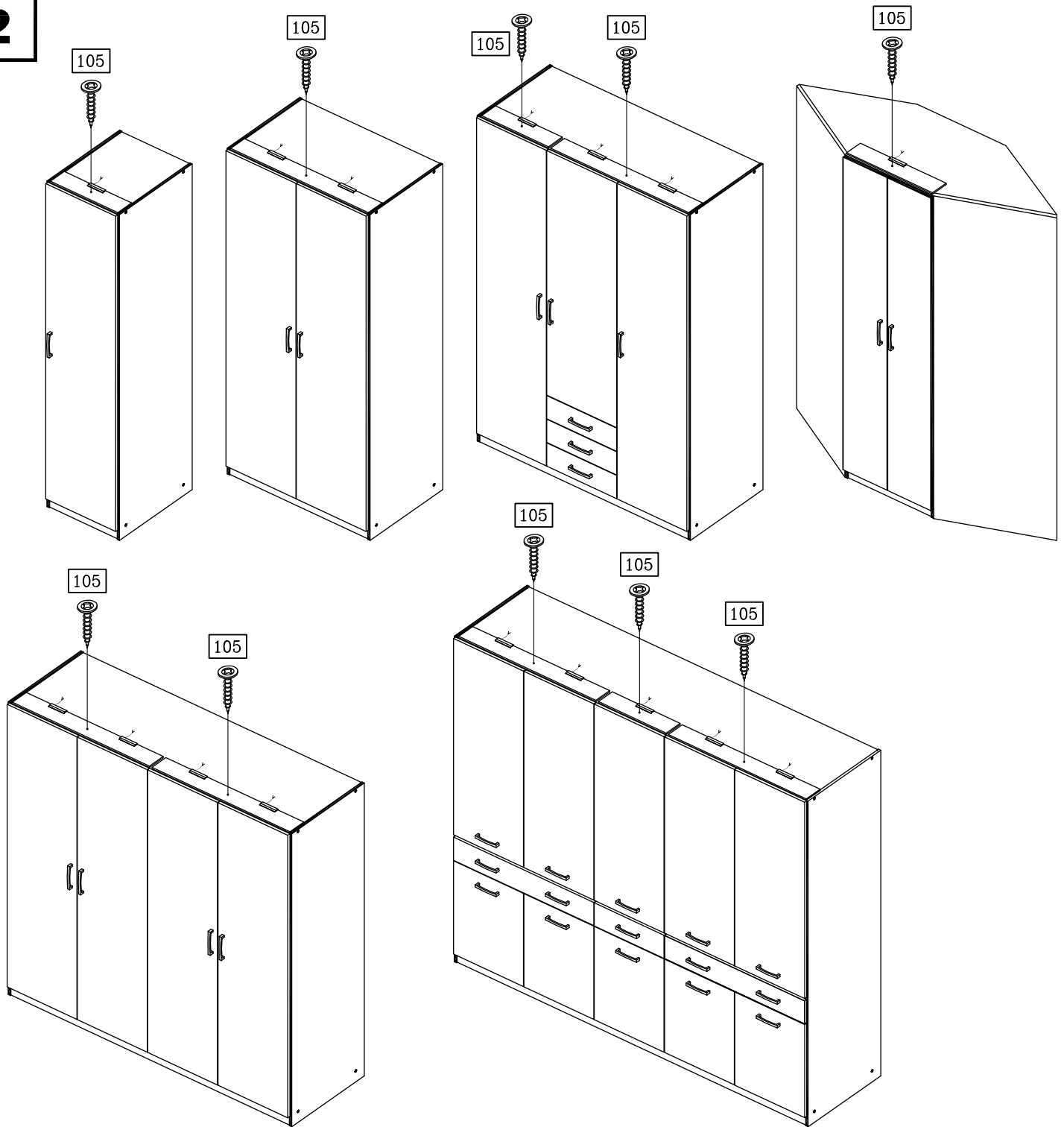
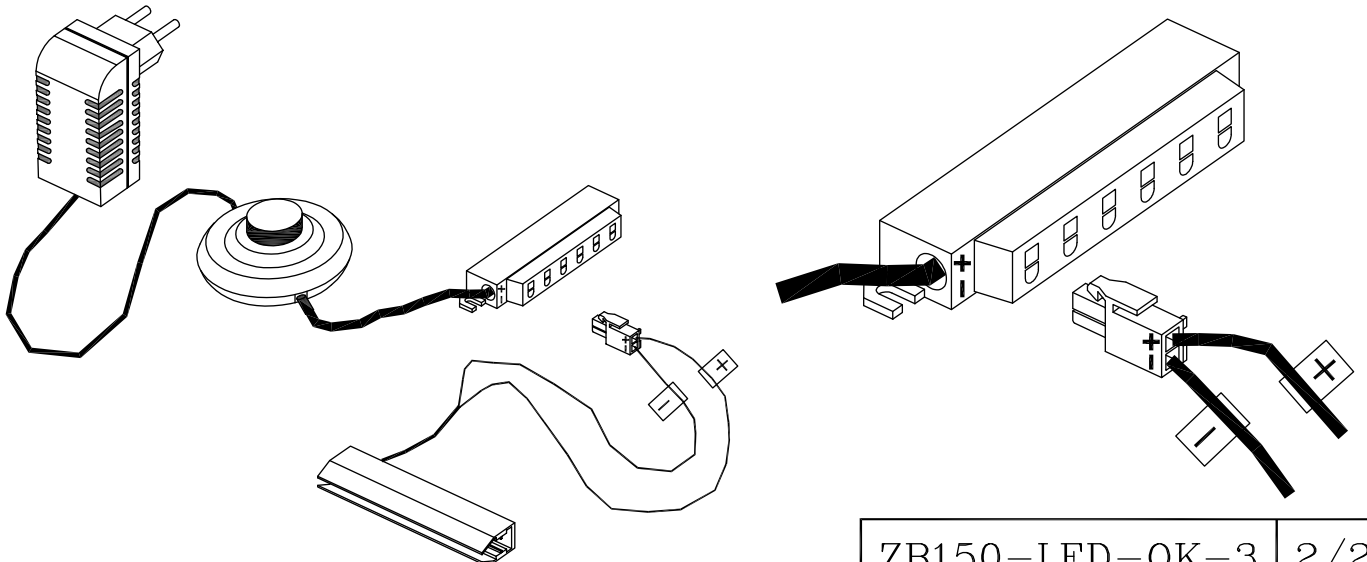
**2****3**

ZB150-LED-OK-3 2/2