

Laila

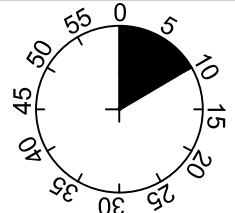

1

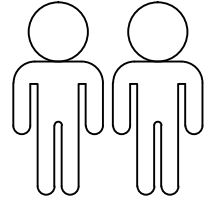
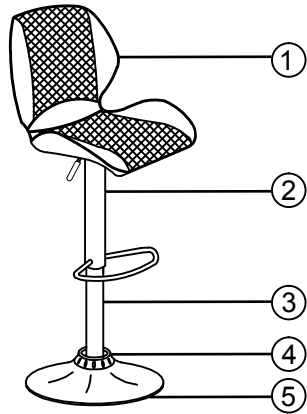
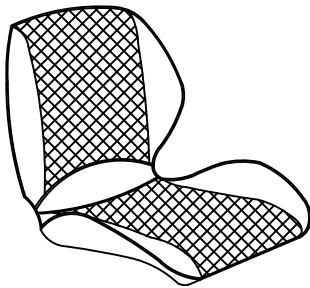

2

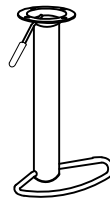

3



4



5



1	1x
2	1x
3	1x
4	1x
5	1x

A M6X20

2x

B M6x30

2x

C Ø18xØ6x1.5

4x

D Ø18xØ8x10

2x

E 4MM

1x

I.



1

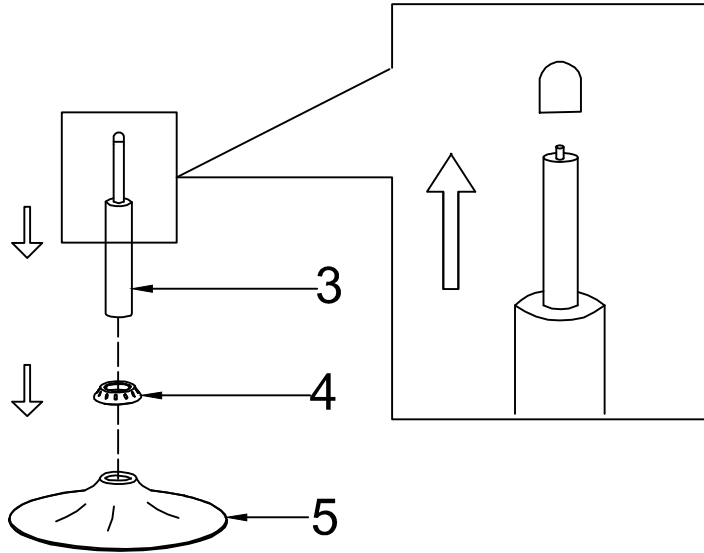

2

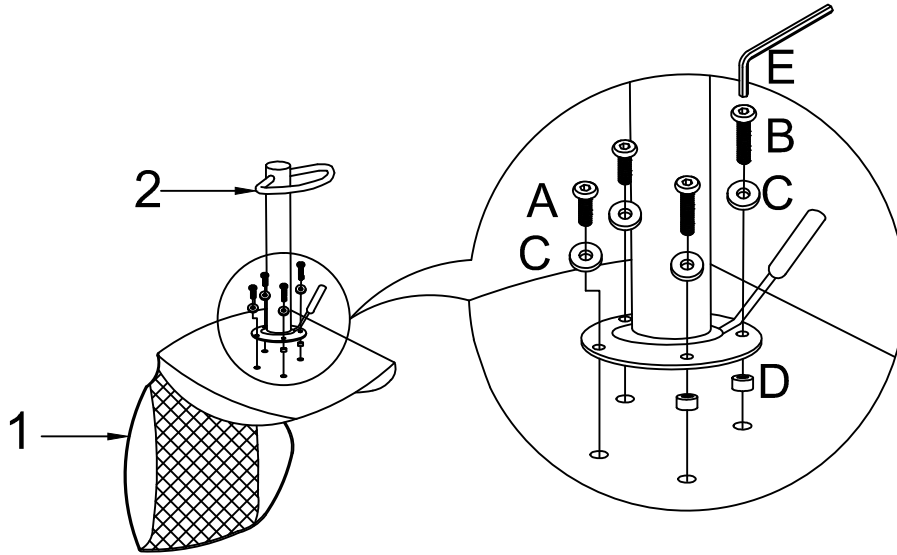

- A M6x20
- 2x
B M6x30
- 2x
C Ø18xØ6x1.5
- 4x
D Ø18xØ8x10
- 2x
E 4MM
- 1x



3

