

- |   |                                     |
|---|-------------------------------------|
| <b>(D)</b> Montageanleitung             | <b>(FR)</b> Notice de montage       |
| <b>(GB)</b> Assembly instructions       | <b>(CZ)</b> Montážní návod          |
| <b>(NL)</b> Handleiding voor de montage | <b>(TR)</b> Montaj talimatı         |
| <b>(HU)</b> Szerelési útmutató          | <b>(IT)</b> Istruzioni di montaggio |
| <b>(PL)</b> Instrukcja montażu          | <b>(SK)</b> Návod na montáž         |
| <b>(RO)</b> Instrucțiuni de montaj      | <b>(RU)</b> Инструкция по монтажу   |

Service • Assistenza • Dienstverlening • Serwis  
 Servis • Szerviz • Сервисная служба

Name • Nom • Nome • Naam • Nazwa • Jméno • Názov • Név • Denumire • Isim • Название	
Nr. • No. • N° • Номер • Č • Sz	
Typ • Type • Tip • Típus • Тип • Тип	

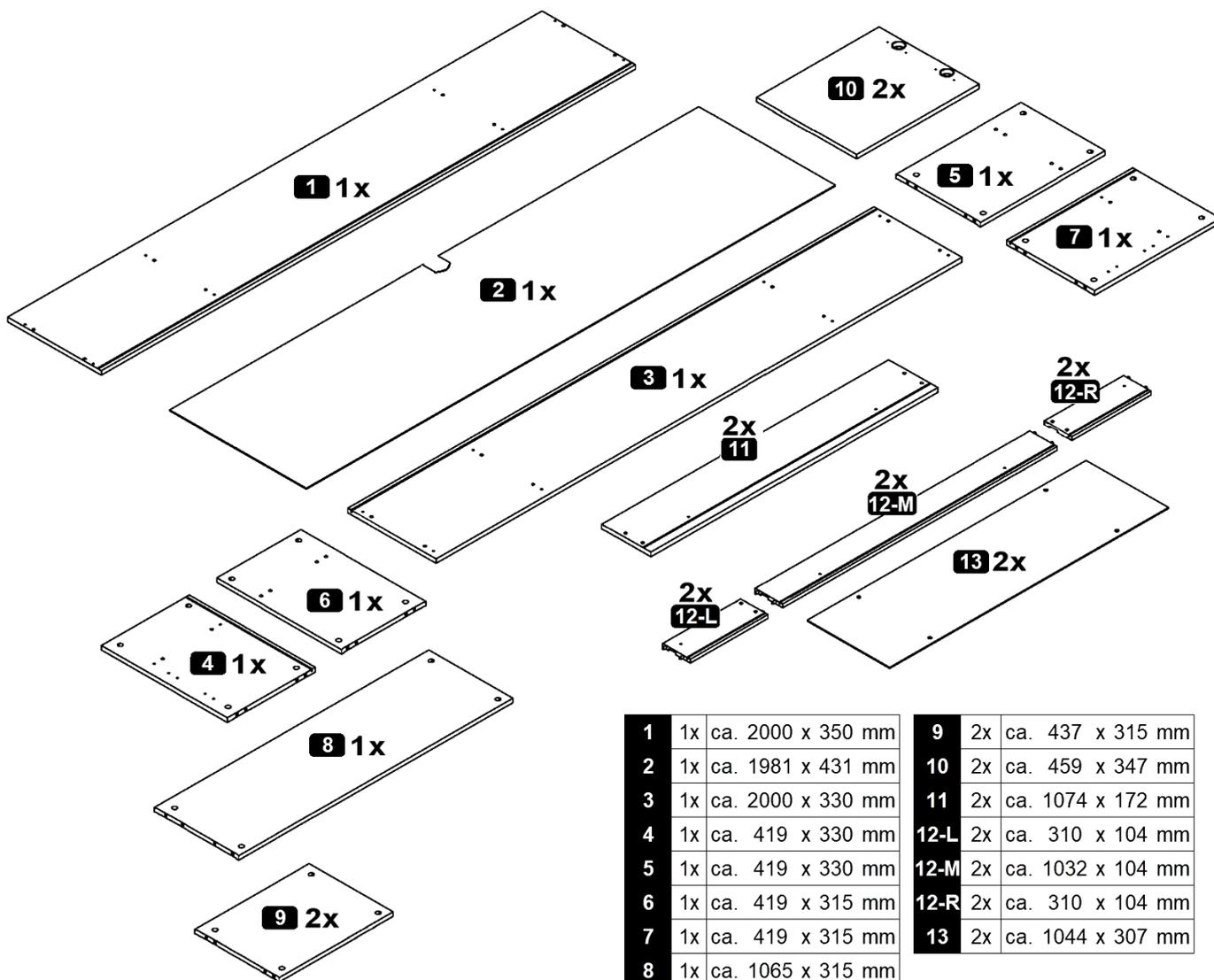
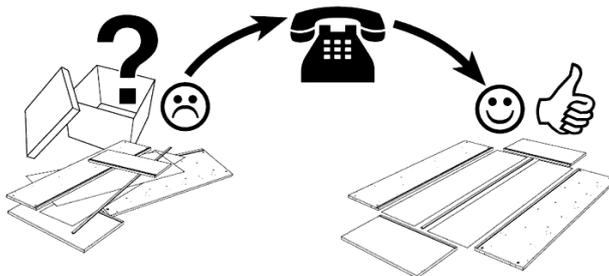
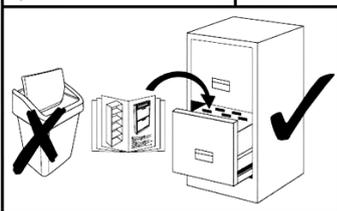

1	1x	ca. 2000 x 350 mm	9	2x	ca. 437 x 315 mm
2	1x	ca. 1981 x 431 mm	10	2x	ca. 459 x 347 mm
3	1x	ca. 2000 x 330 mm	11	2x	ca. 1074 x 172 mm
4	1x	ca. 419 x 330 mm	12-L	2x	ca. 310 x 104 mm
5	1x	ca. 419 x 330 mm	12-M	2x	ca. 1032 x 104 mm
6	1x	ca. 419 x 315 mm	12-R	2x	ca. 310 x 104 mm
7	1x	ca. 419 x 315 mm	13	2x	ca. 1044 x 307 mm
8	1x	ca. 1065 x 315 mm			

A 8,0 x 30 mm  28x	B 20x	C 28x	D 3,9x9,5mm 2x	E h=2 4x	F Ø35 Kr.0 4x	G 2x
H 4,0 x 20 mm  8x	I 8x	J 2,7 x 20 mm  8x	K 6,3 x 13 mm  16x	L 27 x 310 mm  4x	M M4,0 x 9 mm 4x	N 80 mm  4x
O 8x	P Ø13 x 4 mm  4x					



# 1

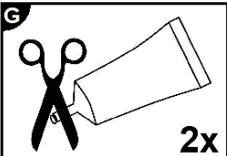
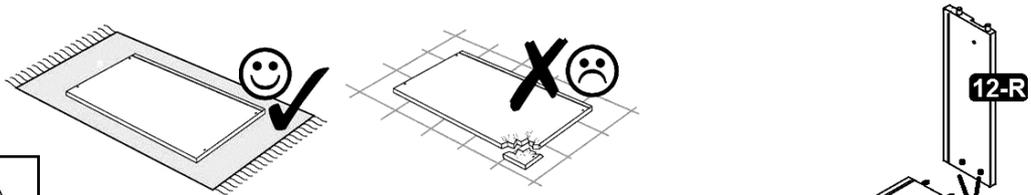

- D Leim
- GB Glue
- FR Colle
- IT Colla
- NL Lijm
- PL Klej
- CZ Lepidlo
- SK Glej
- HU Enyv
- RO Adeziv
- TR Tutkal
- RU Клей

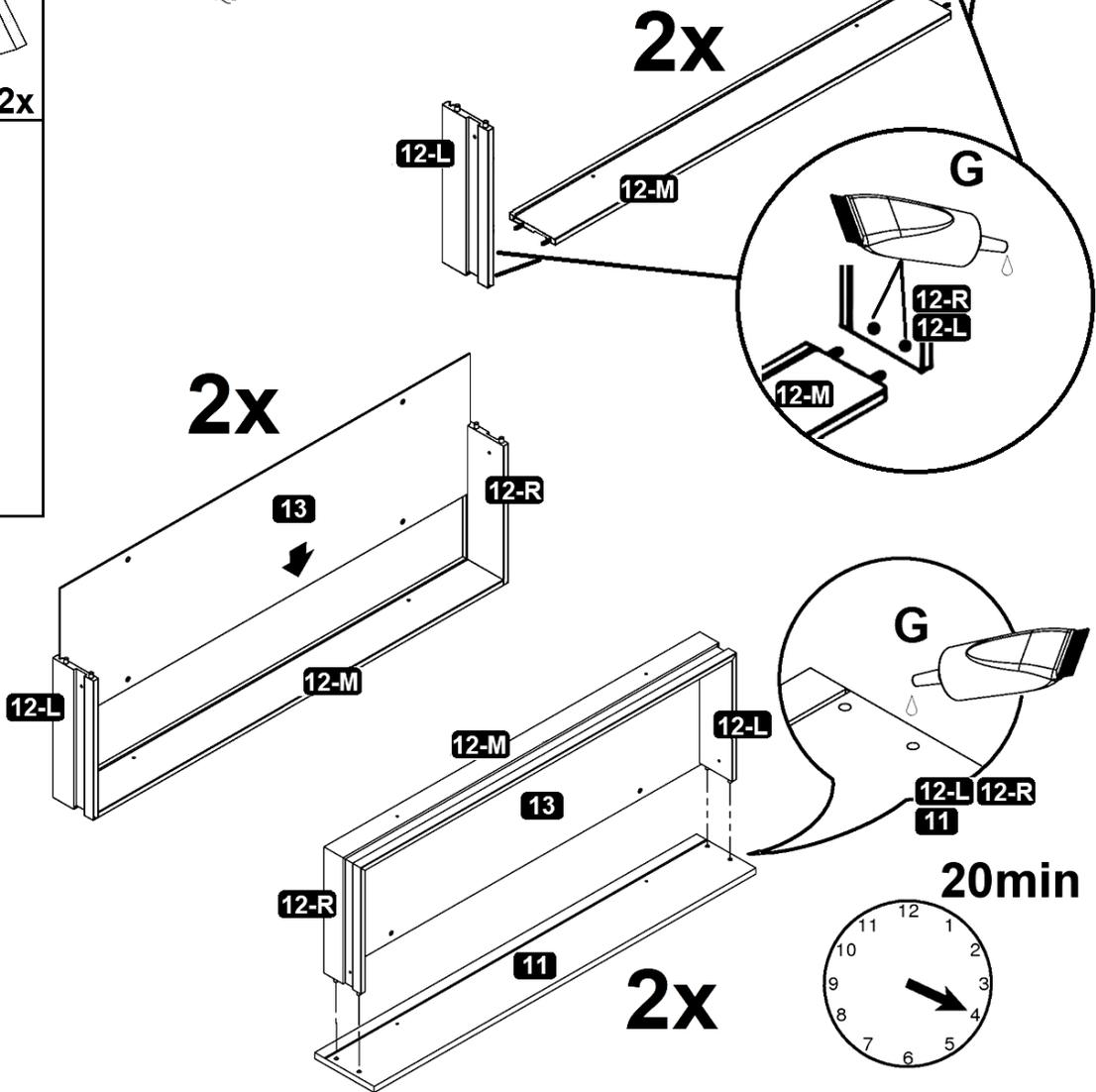

# 2

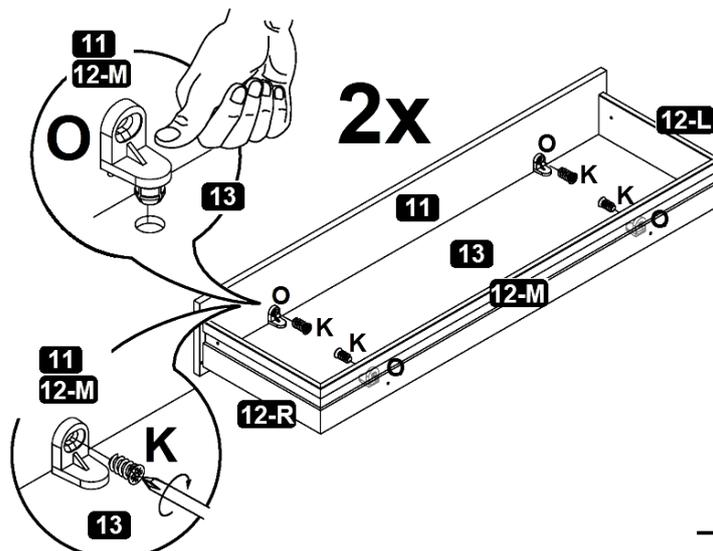
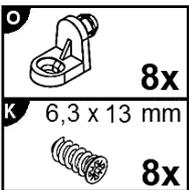

MA1

**3**

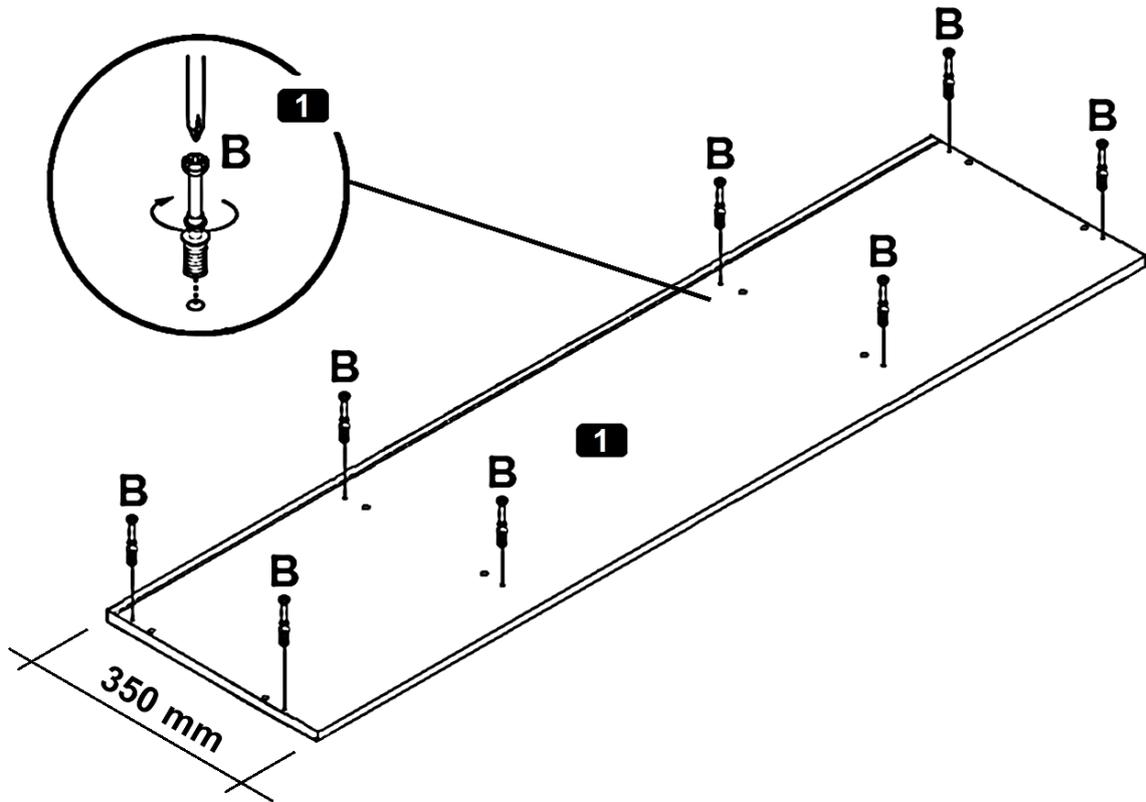
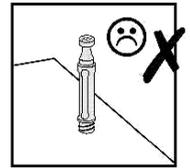
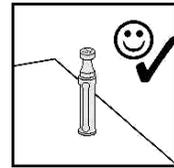
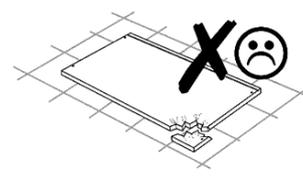
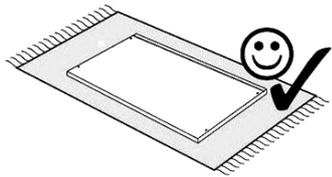

**4**

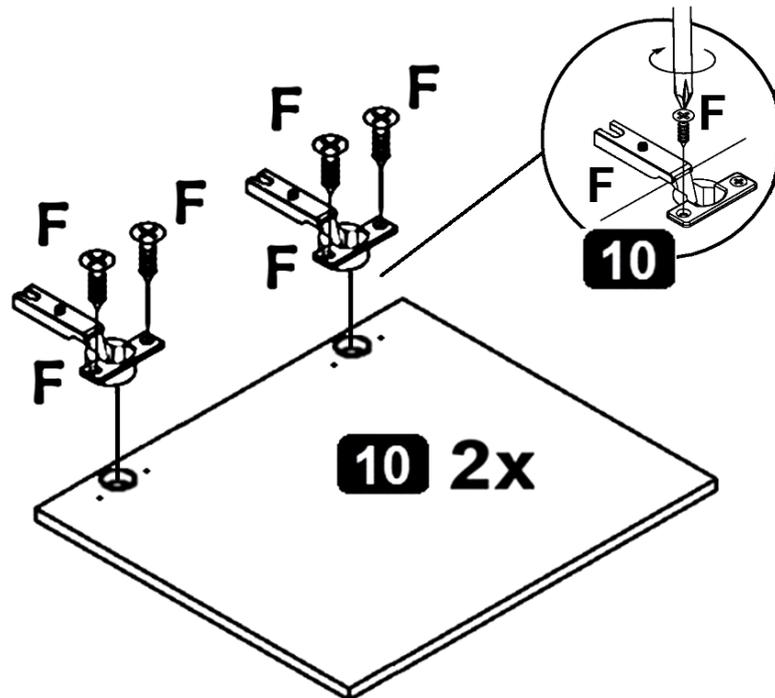
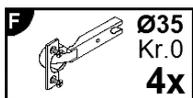

**5**

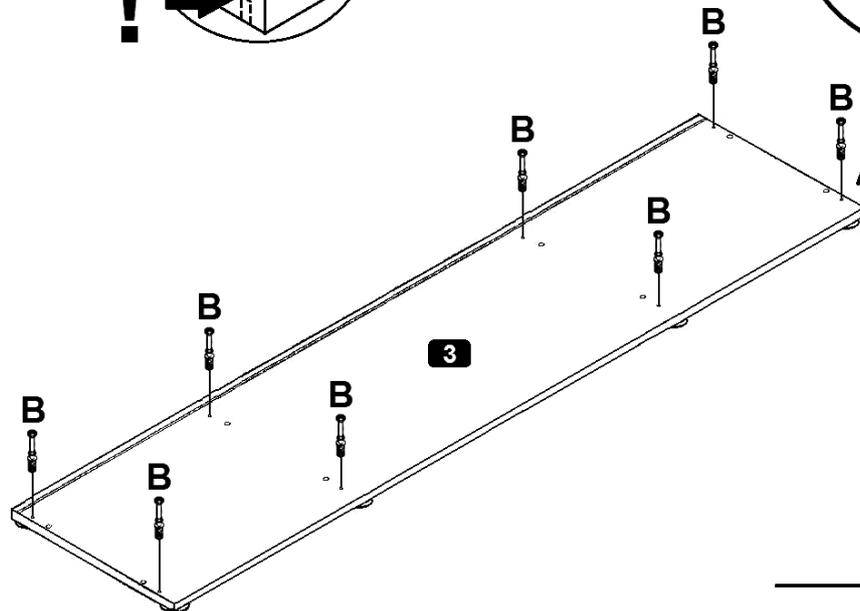
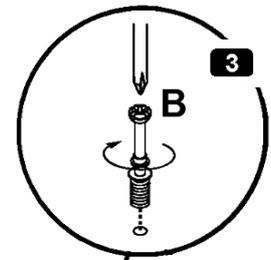
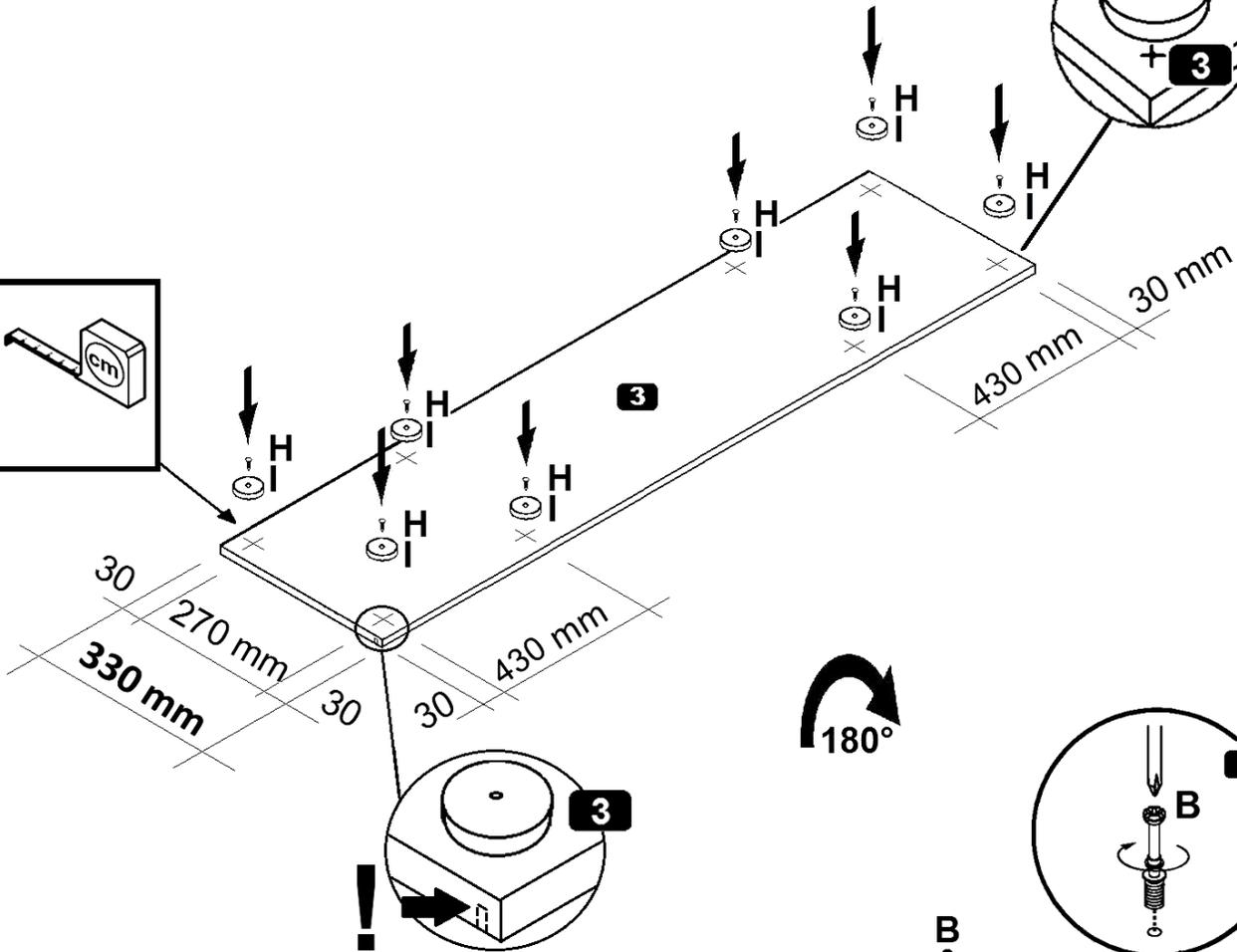
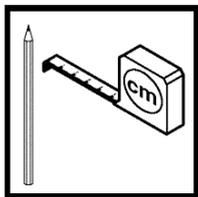
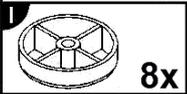
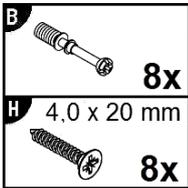
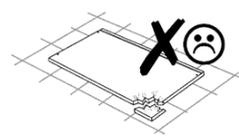
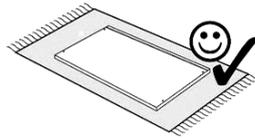
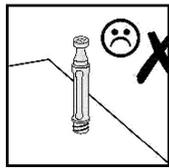
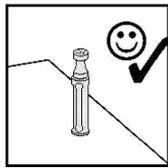

<b>6</b>	<b>B</b>	<b>4x</b>
<b>A</b> 8,0 x 30 mm	<b>C</b>	<b>h=2</b>
<b>20x</b>	<b>20x</b>	<b>4x</b>

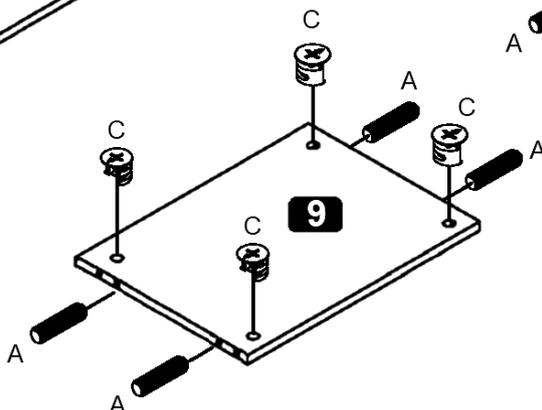
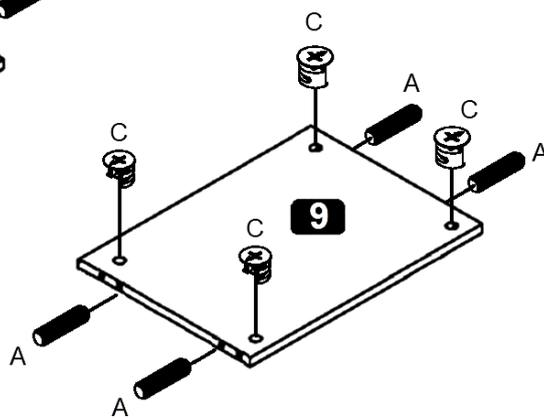
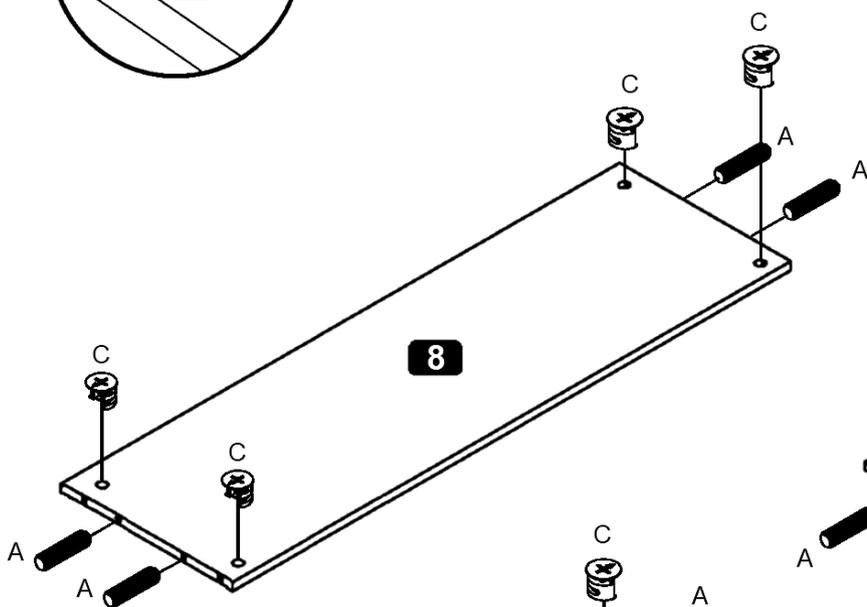
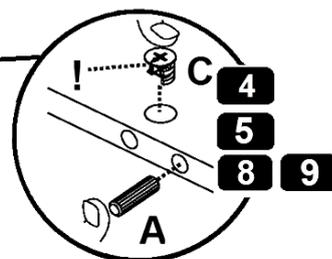
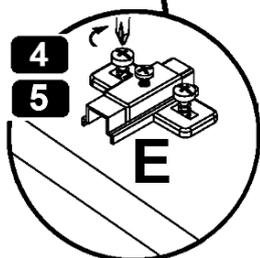
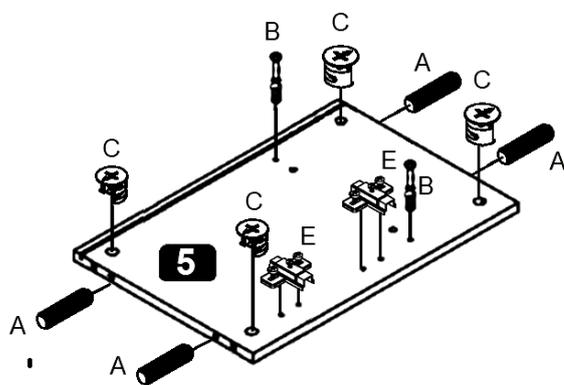
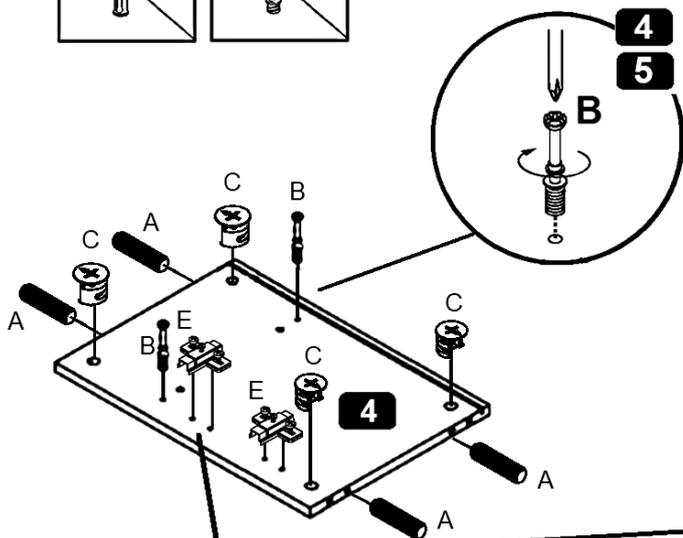
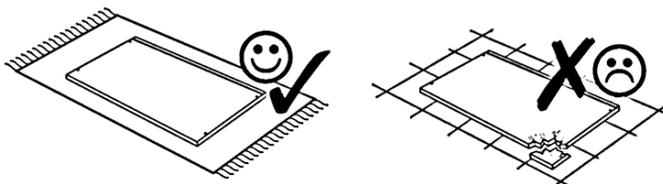

# 7

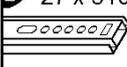
<b>A</b> 8,0 x 30 mm  8x	<b>C</b>  8x	<b>K</b> 6,3 x 13 mm  8x	<b>L</b> 27 x 310 mm  4x	<b>D</b> 3,9x9,5mm  2x
--	--	--	--	--

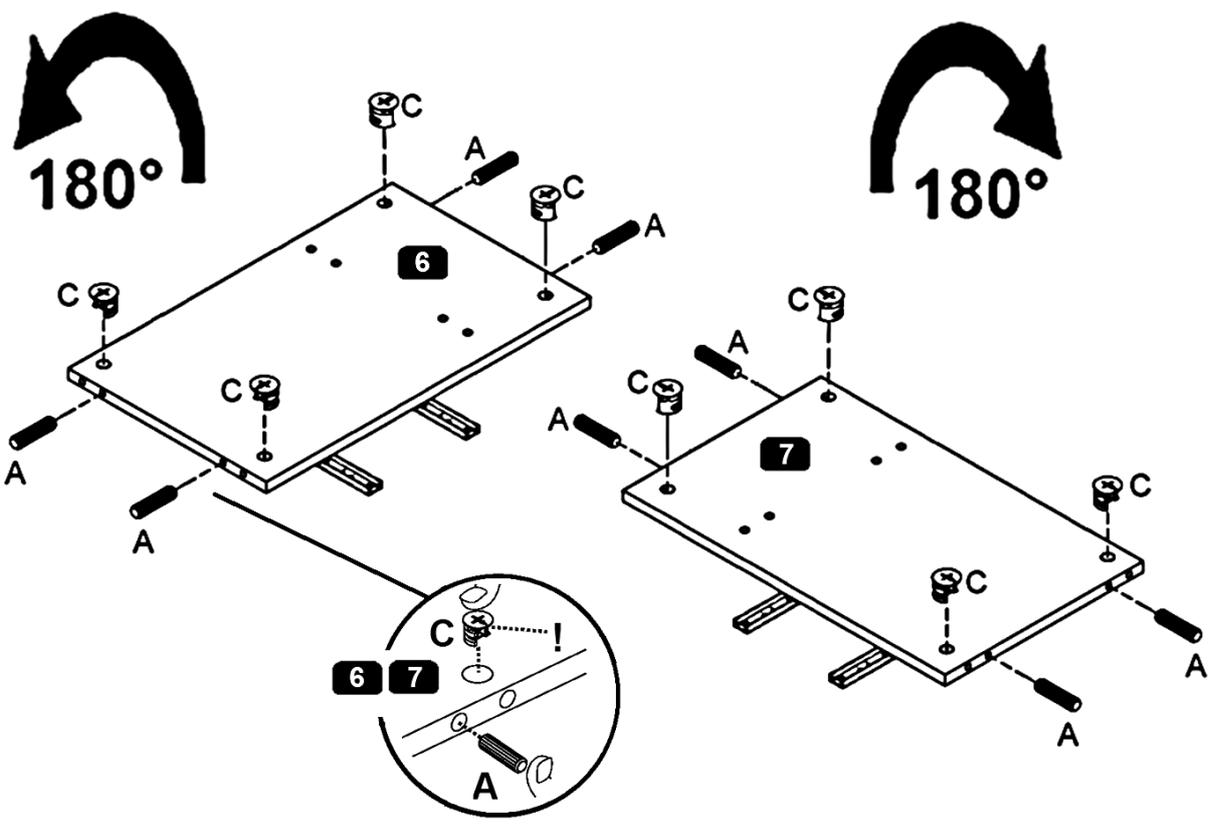
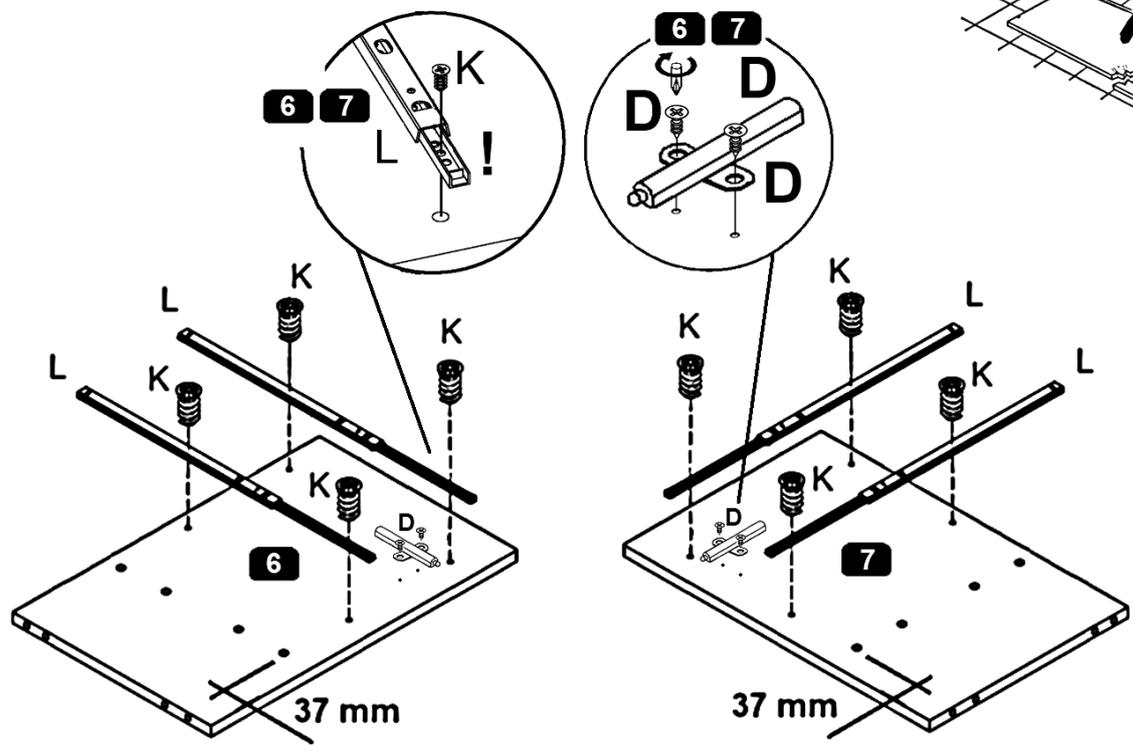
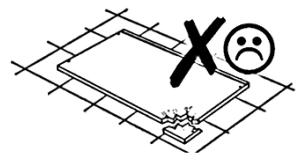
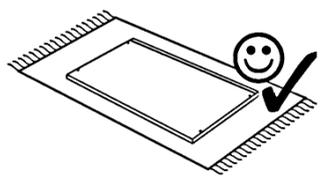

# 8

N 80 mm  
4x

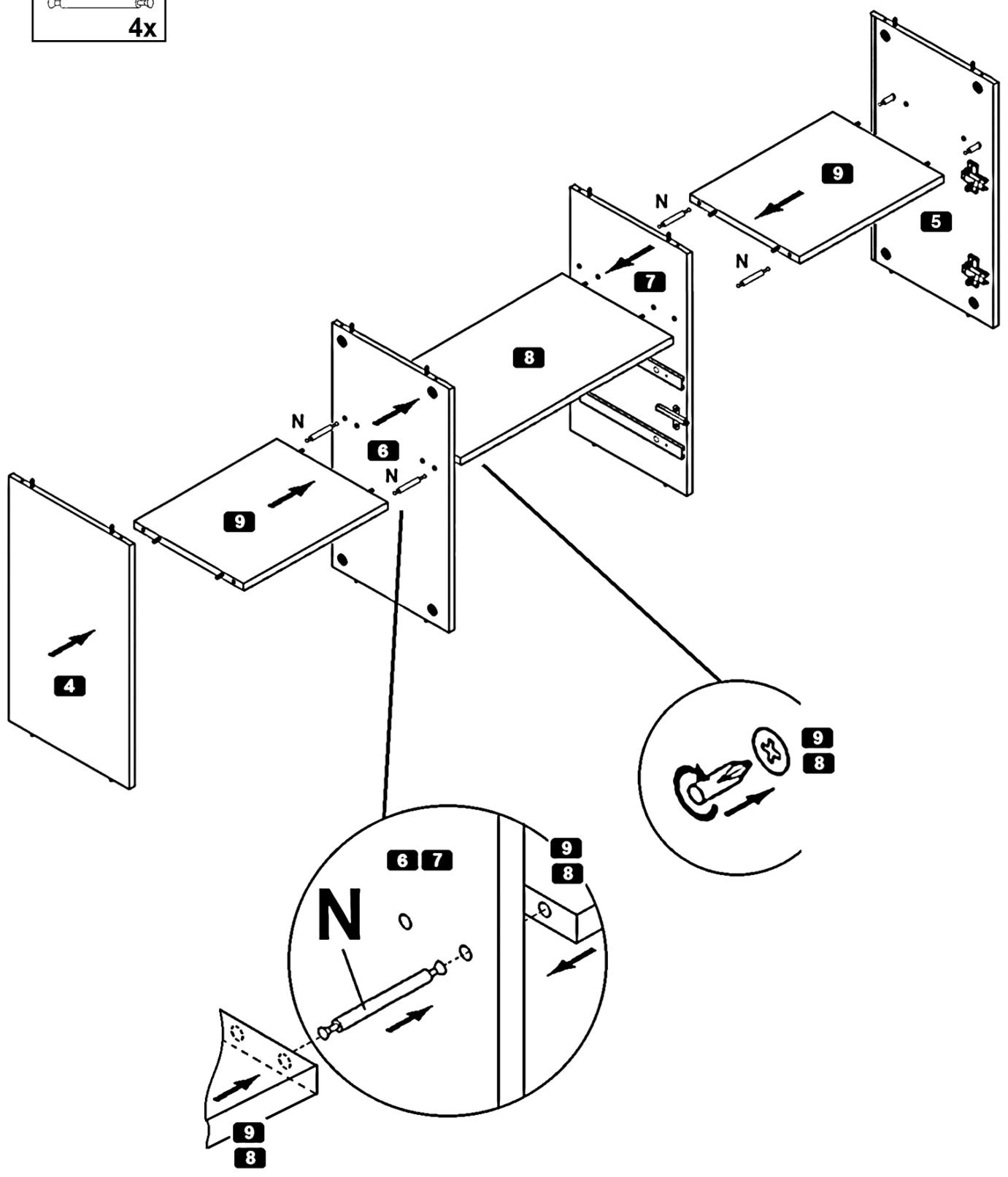



# 9

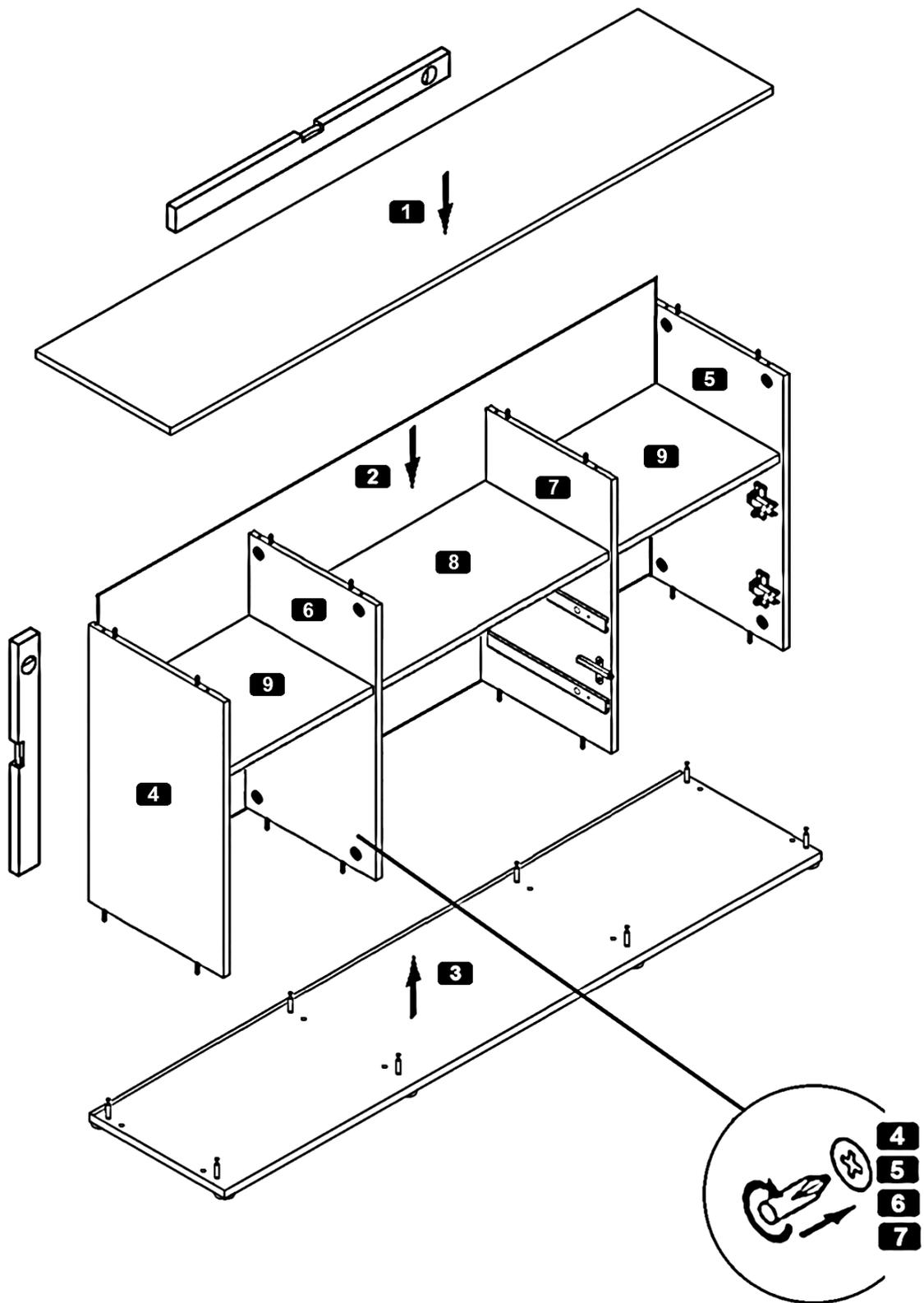

# 10

J 2,7 x 20 mm  
8x

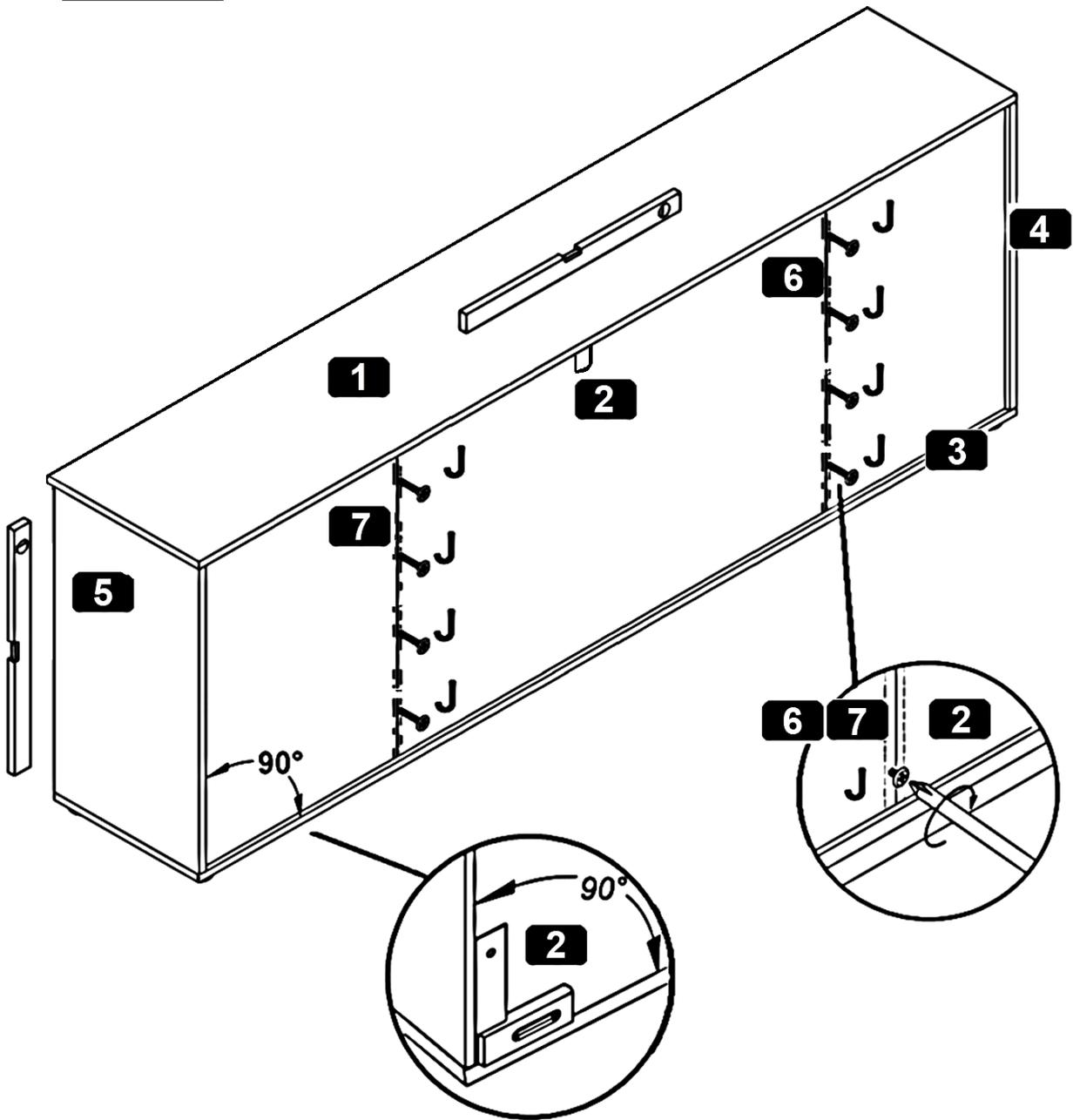

**11**

M	M4,0 x 9 mm		4x
P	Ø13 x 4 mm		2x

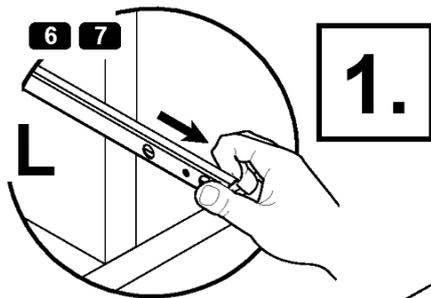
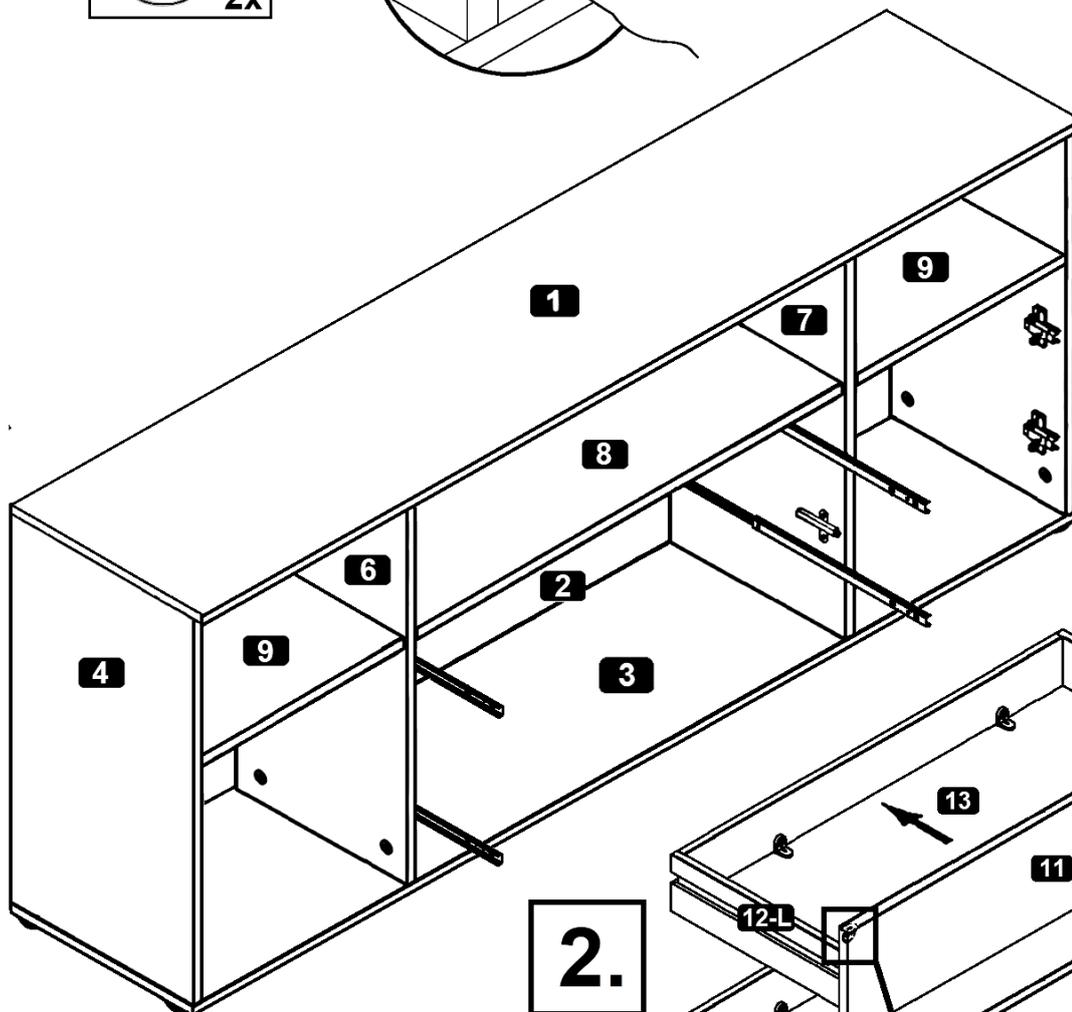
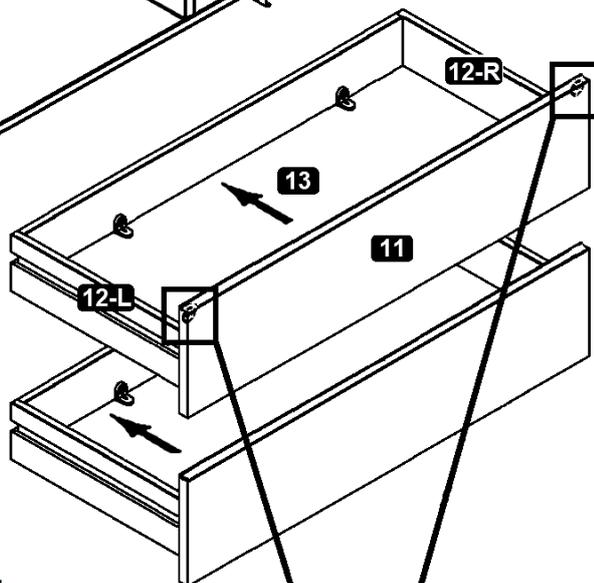
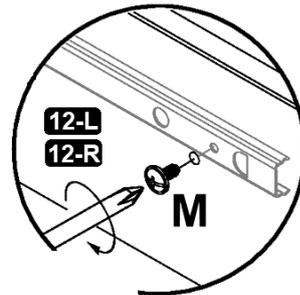
**1.****2.****3.**

- (D) Wichtig! Bitte genau hier anbringen!
- (GB) Important! Please attach right here!
- (FR) Important! Veuillez joindre ici!
- (RU) Важно! Пожалуйста, прикрепите прямо здесь!
- (TR) Önemli! Lütfen buraya ekleyin!
- (IT) ! importante Si prega di allegare proprio qui!
- (NL) Belangrijk! Voeg hier toe!
- (PL) Ważne! Dołącz tutaj!
- (CZ) Důležité! Připojte se prosím zde!
- (RO) Important! Vă rugăm să atașați chiar aici!
- (HU) Fontos! Kérjük, csatolja ide!
- (SK) Dôležité! Pripojte, prosím, tu!

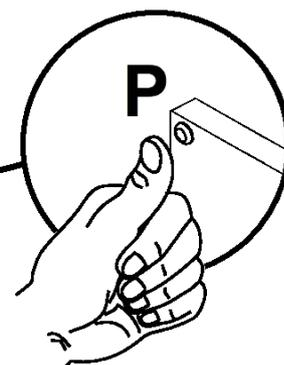
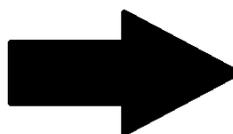

MA1

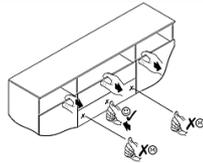

- |  |  |
|--|--|
| <p><b>(D)</b> Fronten bitte wie unten beschrieben öffnen. Türen und obere Schublade werden durch Ziehen geöffnet.</p>          | <p><b>(CZ)</b> Otevřete prosím přední strany, jak je popsáno níže. Dveře a horní zásuvka se otevírají tahem.</p>                           |
| <p><b>(GB)</b> Please open fronts as described below. Doors and upper drawer are opened by pulling.</p>                        | <p><b>(RO)</b> Vă rugăm să deschideți fronturile, așa cum este descris mai jos. Ușile și sertarul superior sunt deschise prin tragere.</p> |
| <p><b>(FR)</b> Veuillez ouvrir les façades comme décrit ci-dessous. Les portes et le tiroir supérieur s'ouvrent en tirant.</p> | <p><b>(HU)</b> Kérjük, nyissa meg a frontokat az alábbiak szerint. Az ajtókat és a felső fiókot húzással lehet kinyitni.</p>               |
| <p><b>(IT)</b> Si prega di aprire i fronti come descritto di seguito. Le porte e il cassetto superiore si aprono tirando.</p>  | <p><b>(SK)</b> Otvorte prosím predné časti, ako je opísané nižšie. Dvere a horná zásuvka sa otvárajú potiahnutím.</p>                      |
| <p><b>(NL)</b> Open de fronten zoals hieronder beschreven. Deuren en bovenste lade worden geopend door eraan te trekken.</p>   | <p><b>(TR)</b> Lütfen cepheleri aşağıda açıklandığı gibi açın. Kapılar ve üst çekmece çekilerek açılır.</p>                                |
| <p><b>(PL)</b> Otwórz fronty, jak opisano poniżej. Drzwi i górna szuflada są otwierane przez pociągnięcie.</p>                 | <p><b>(RU)</b> Пожалуйста, откройте frontы, как описано ниже. Двери и верхний ящик открываются, потянув.</p>                               |

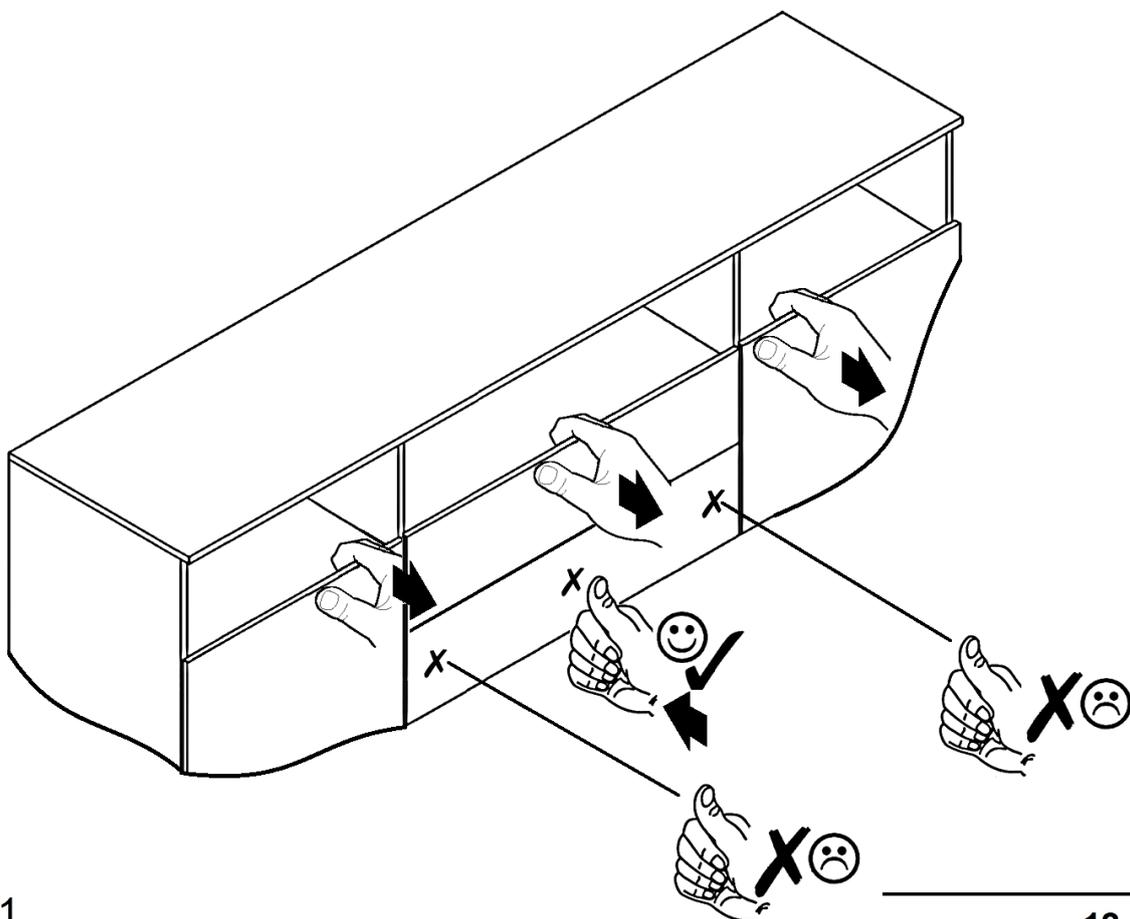

# 13

P Ø13 x 4 mm  
 2x

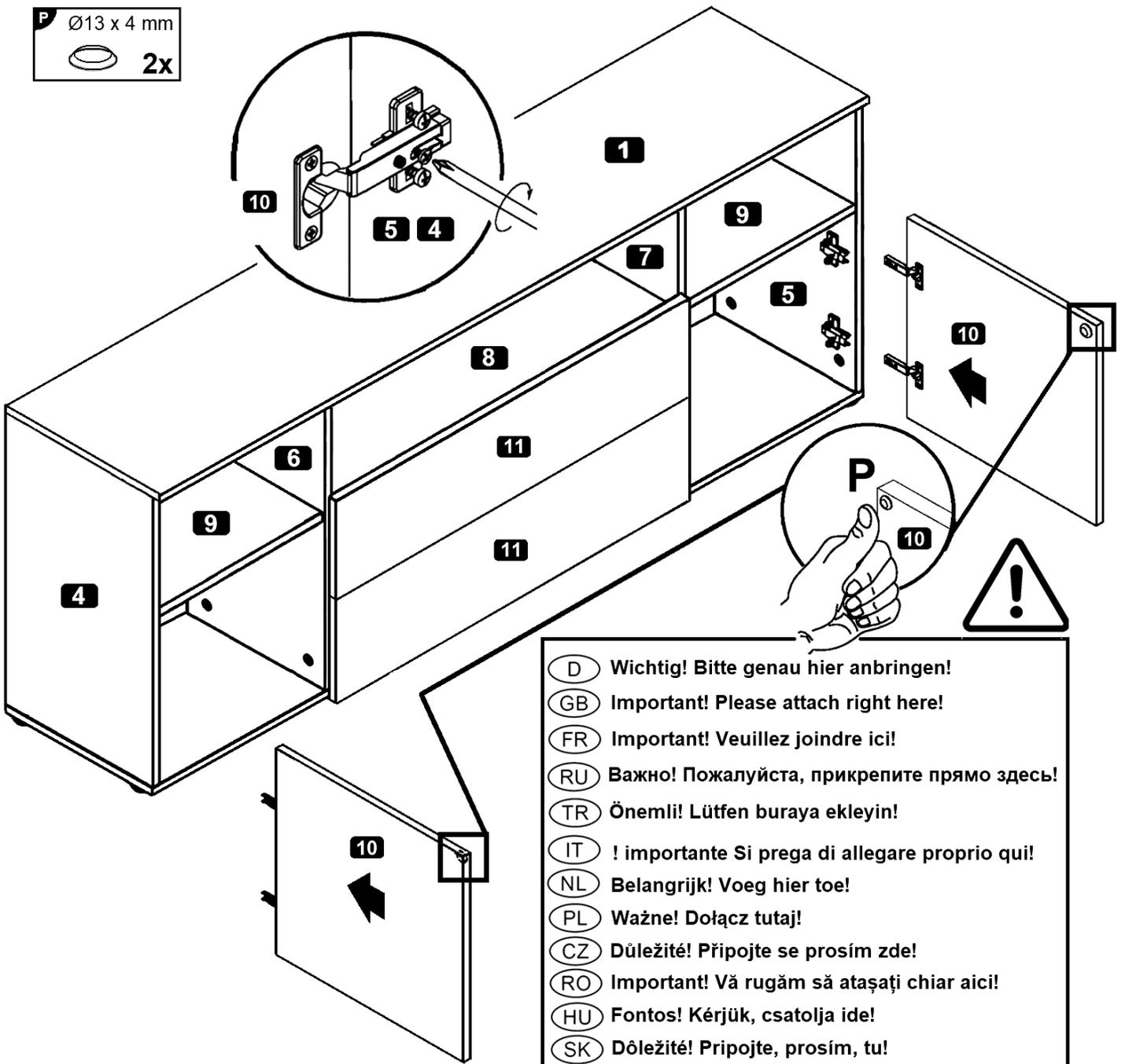

- (D) Wichtig! Bitte genau hier anbringen!
- (GB) Important! Please attach right here!
- (FR) Important! Veuillez joindre ici!
- (RU) Важно! Пожалуйста, прикрепите прямо здесь!
- (TR) Önemli! Lütfen buraya ekleyin!
- (IT) ! importante Si prega di allegare proprio qui!
- (NL) Belangrijk! Voeg hier toe!
- (PL) Ważne! Dołącz tutaj!
- (CZ) Důležité! Připojte se prosím zde!
- (RO) Important! Vă rugăm să atașați chiar aici!
- (HU) Fontos! Kérjük, csatolja ide!
- (SK) Dôležité! Pripojte, prosím, tu!

- (PL) Nastawić drzwi (wyregulować zawiasy)
- (CZ) Vyrovnajte dvířka (seřid'te závěsy)
- (RO) Nastavenie dverí (nastavenie závesov)
- (HU) Állítsa be az ajtókat (állítsa be a zsanérokot)
- (SK) Reglare uși (ajustare balamale)
- (TR) Kapıların ayarlanması (menteşelerin seviye ayarı)
- (RU) Регулировка дверей (регулировка шарнира)

**➔ 14 / 14** 

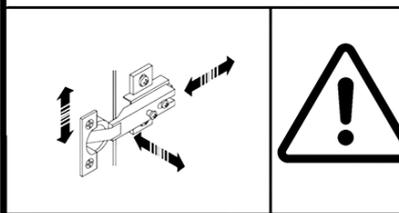

- (D) Türen einstellen (Scharniere justieren)
- (GB) Adjusting the doors (adjusting the hinges)
- (FR) Régler les portes (ajuster les charnières)
- (IT) Sistemare le porte (regolare le cerniere)
- (NL) Deuren instellen (scharnieren afstellen)

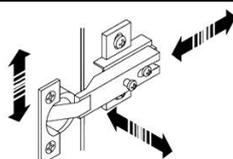

**(D)** Türen einstellen  
(Scharniere justieren)

**(GB)** Adjusting the doors  
(adjusting the hinges)

**(FR)** Régler les portes  
(ajuster les charnières)

**(IT)** Sistemare le porte  
(regolare le cerniere)

**(NL)** Deuren instellen  
(scharnieren afstellen)

**(PL)** Nastawić drzwi  
(wyregulować zawiasy)

**(CZ)** Vyrovnajte dvířka  
(seřid'ťe závěsy)

**(RO)** Nastavenie dverí  
(nastavenie závesov)

**(HU)** Állítsa be az ajtókat  
(állítsa be a zsanérokot)

**(SK)** Reglare uši  
(ajustare balamale)

**(TR)** Kapıların ayarlanması  
(menteşelerin seviye ayarı)

**(RU)** Регулировка дверей  
(регулировка шарнира)

