

FLORENZ 22M

OPTION L

OPTION R

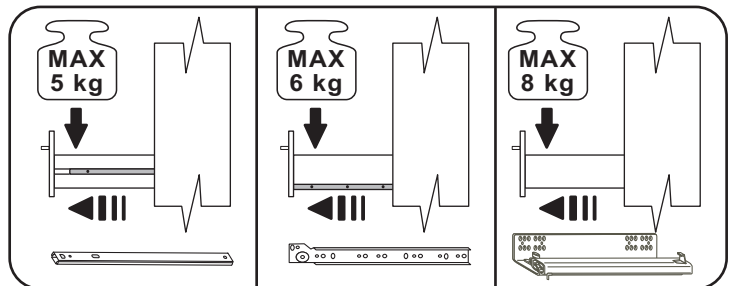
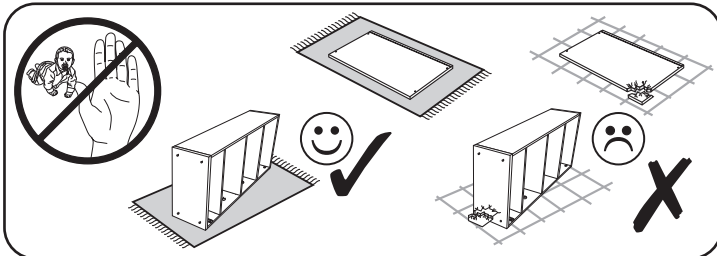
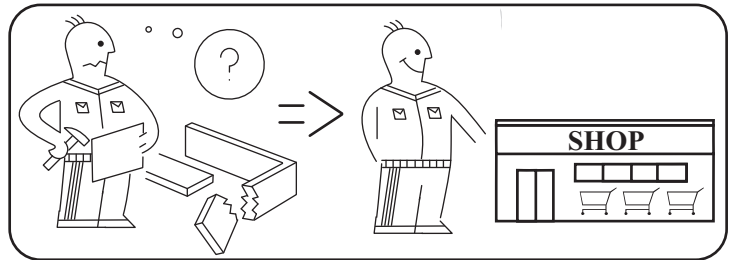
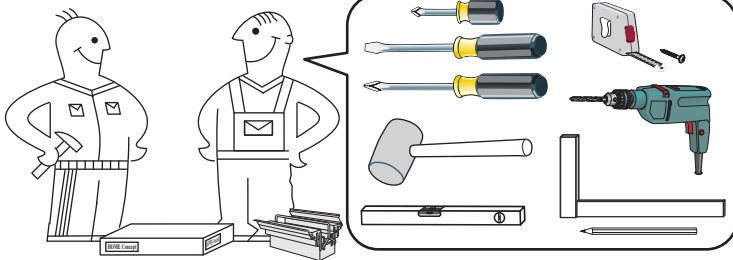
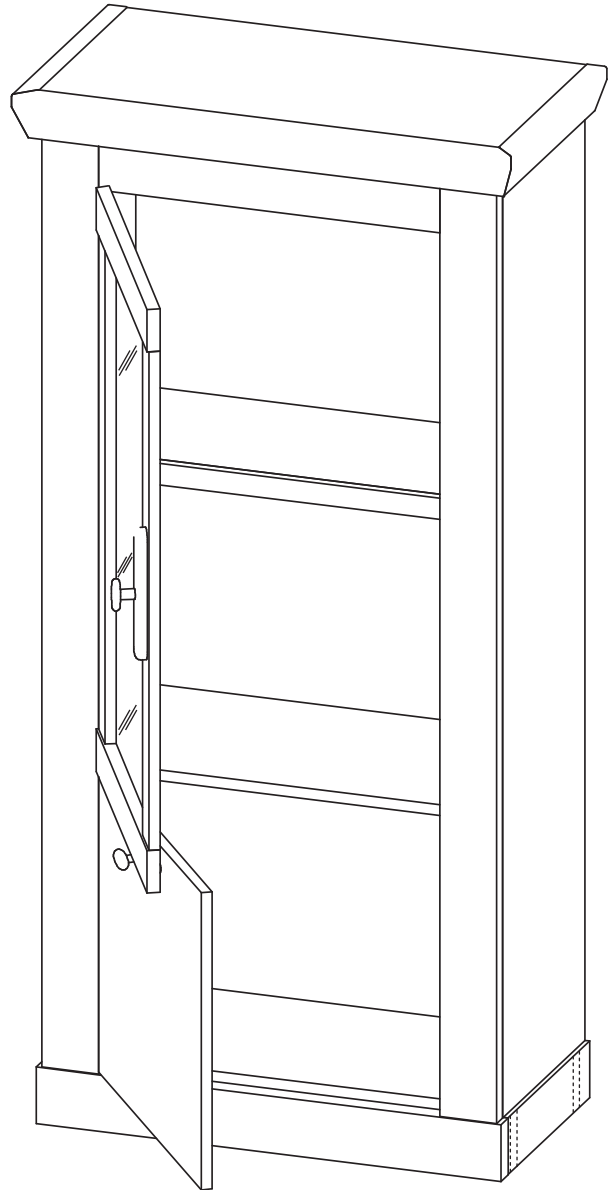
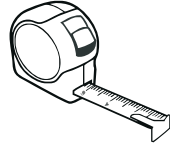
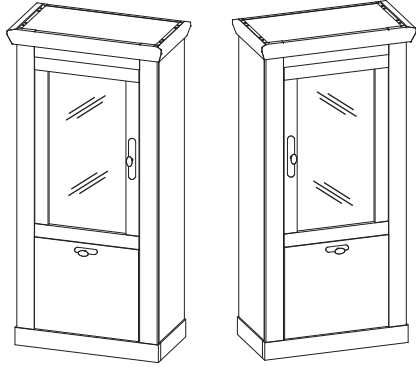

FLORENZ 22M

OPTION L

OPTION R

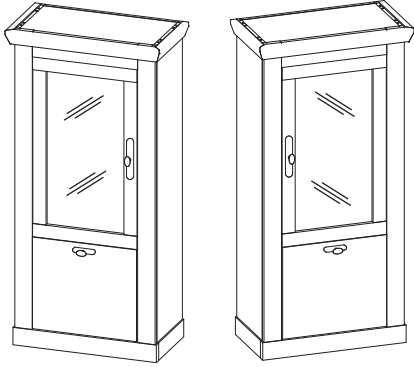

max.



MHC4

max.



MHC3

MHC12

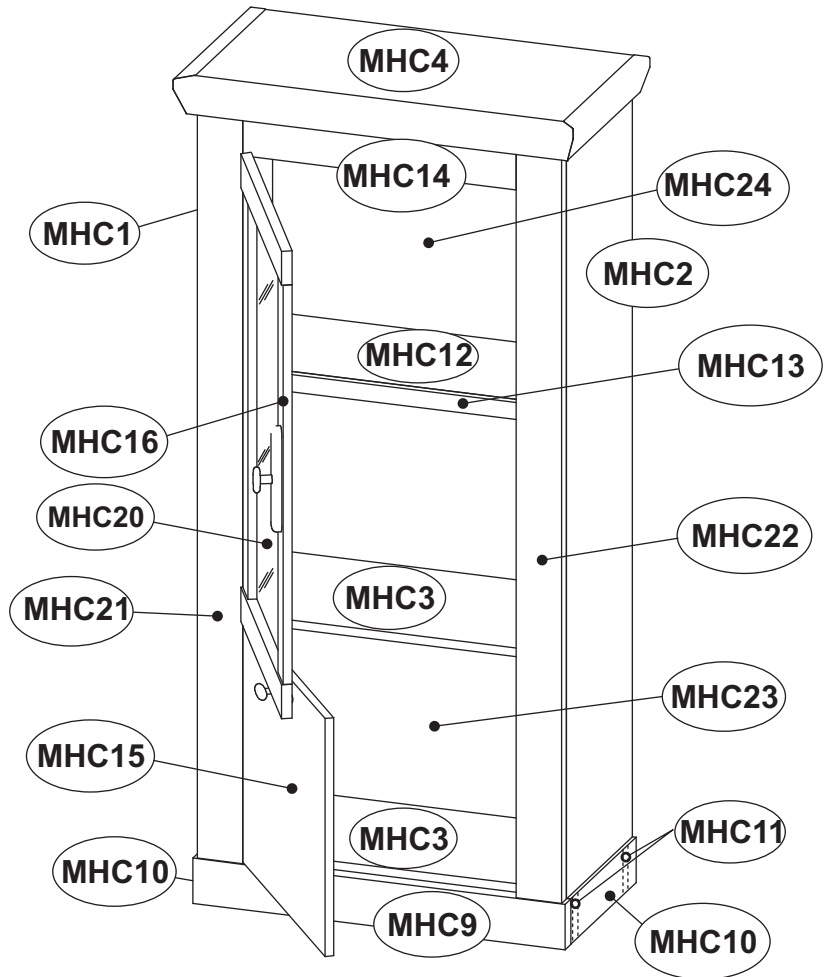

MHC1	1361	320	15	1/1
MHC2	1361	320	15	1/1
MHC3	611	299	15	1/1
MHC4	699	370,5	65	1/1
MHC9	655	80	28	1/1
MHC10	317	80	28	1/1
MHC11	598	80	15	1/1
MHC12	610	267	15	1/1
MHC13	608	30	16	1/1
MHC14	483	120	18	1/1

MHC15	419	477	15	1/1
MHC16	813	477	18	1/1
MHC20	723	386	4	1/1
MHC21	1361	80	22	1/1
MHC22	1361	80	22	1/1
MHC23	421	623	3	1/1
MHC24	945	623	3	1/1

FLORENZ 22M

HCB1  1018
8x28 x17

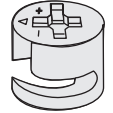
HCM1  123894
x20

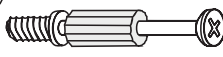
HCT1  11809
x20

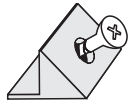
HCJ23  1302
x12

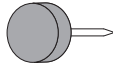
HCF36  1305
x8

HCC6  0000
φ20 x8

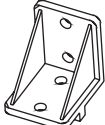
HCK13  49716
x14

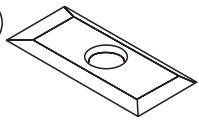
HCF1  1415
x4

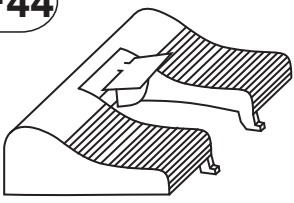
HCF44  116795
x2

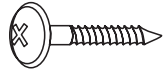
HCP2  1014
3,5x13 x1

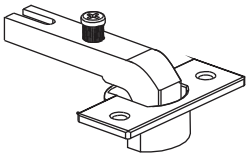
HCZ4  49365
φ35 90° x4

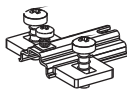
HCD14  23515
H4 x4

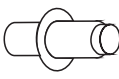
HCW1  1289
x4

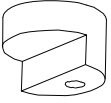
HCG5  1356
x12

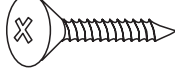
HCS11  1073
3x16 x12

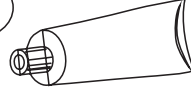
HCL1  1006
x1

HCP13  1012
4x30 x3

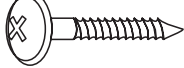
HCP6  1056
3x20 x8

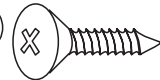
HCS3  1011
3,5x13 x72

HCF14  1021
x2

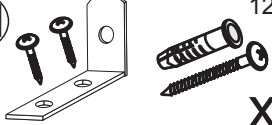
HCJ11  1267
x1

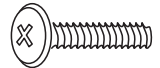
HCA6  2549
WPM 4x22 x4

HCG54  126680
x1

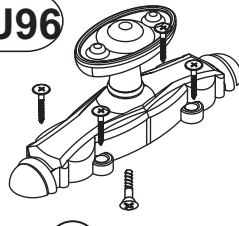
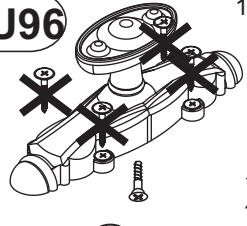

HCU96 126321  x1 =  x1

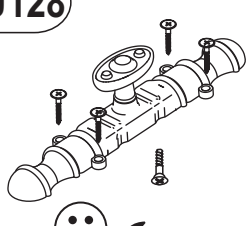
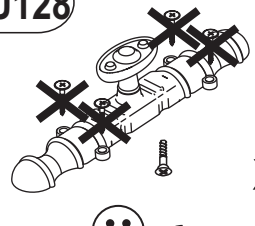
☺ ✓

HCU128 126322  x1 =  x1

☺ ✓

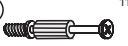

1

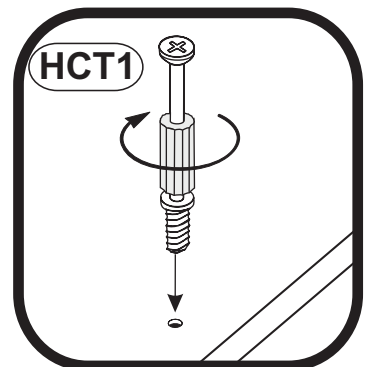
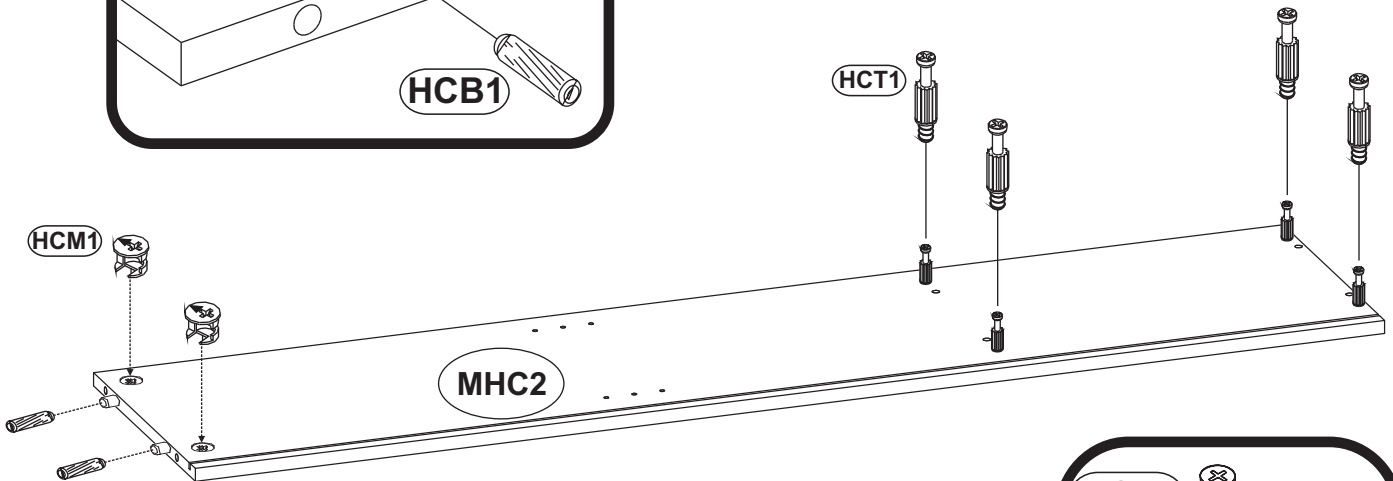
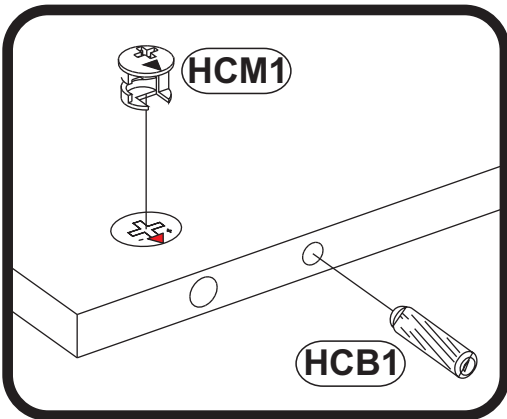
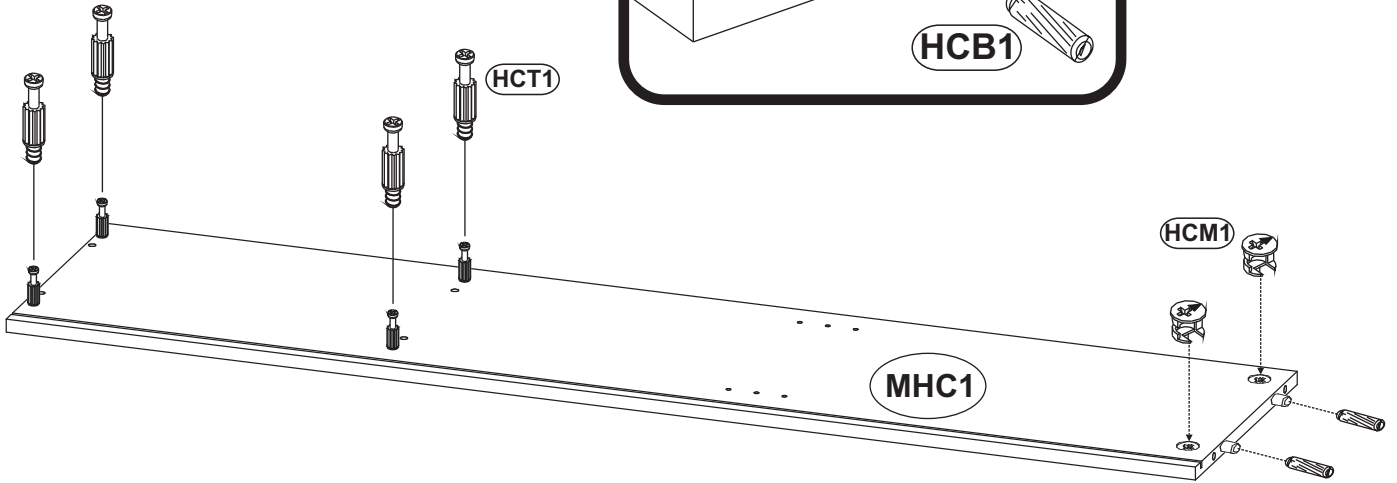
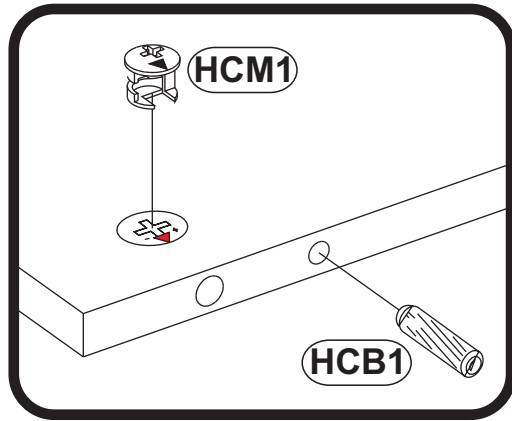
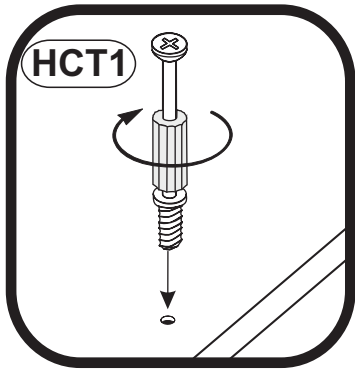
HCB1		1018
	8x28	x4
HCM1		123894
		x4
HCT1		11809
		x8



2

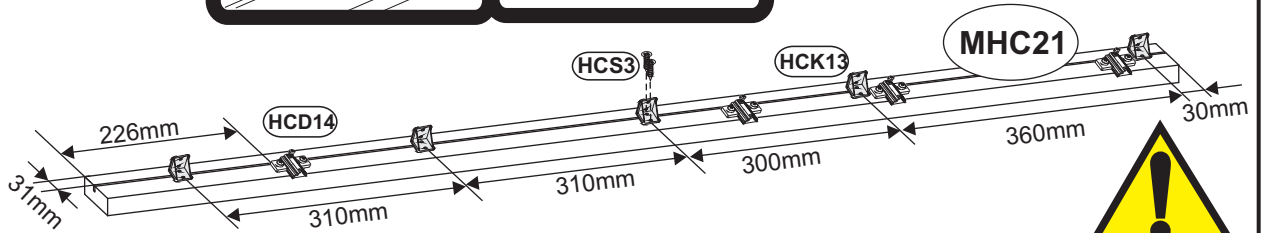
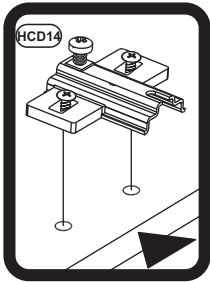
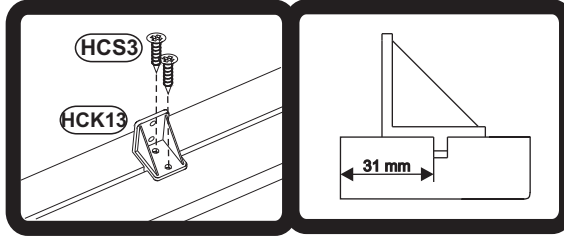
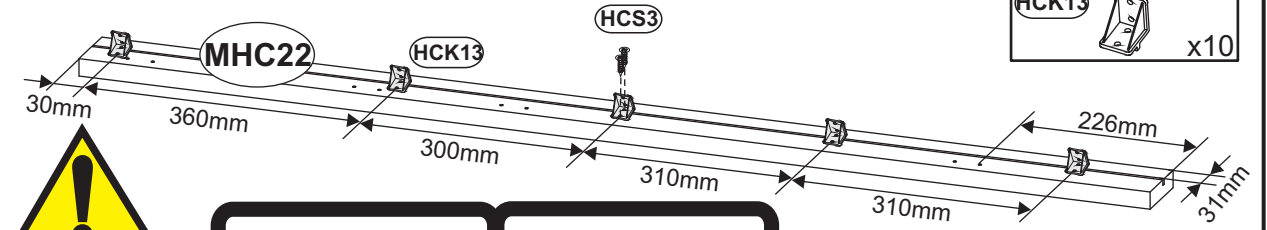
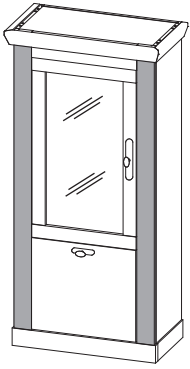

OPTION L

HCD14		23515
	H4	x4
HCS3		1011
	3,5x13	x20
HCK13		49716
		x10





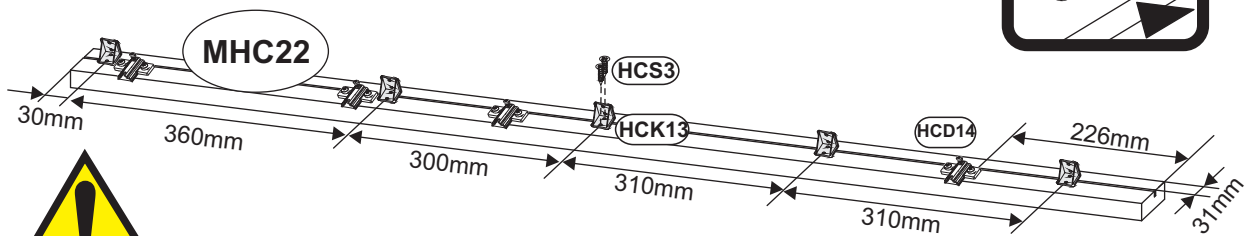
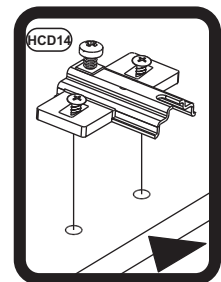
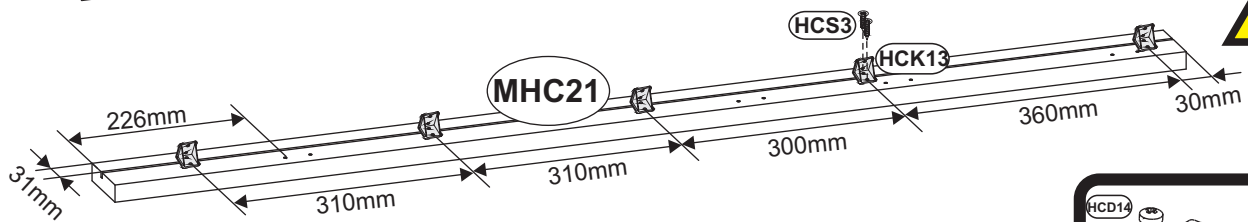
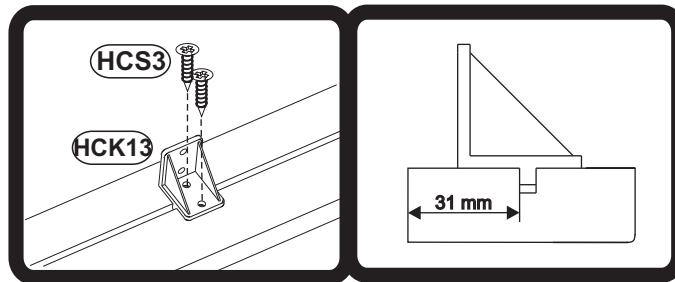
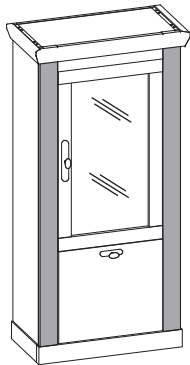

3

OPTION R

HCD14		23515
	H4	x4
HCS3		1011
	3,5x13	x20
HCK13		49716
		x10



HCF14  1021	HCB1  1018
x2	8x28 x8
HCS3  1011	HCM1  123894
3,5x13 x4	x8
HCT1  11809	
x4	



x2

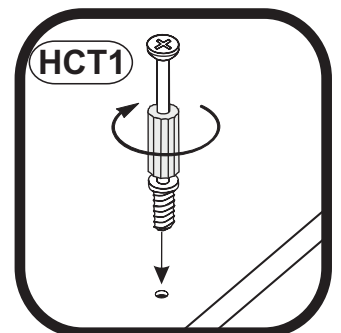
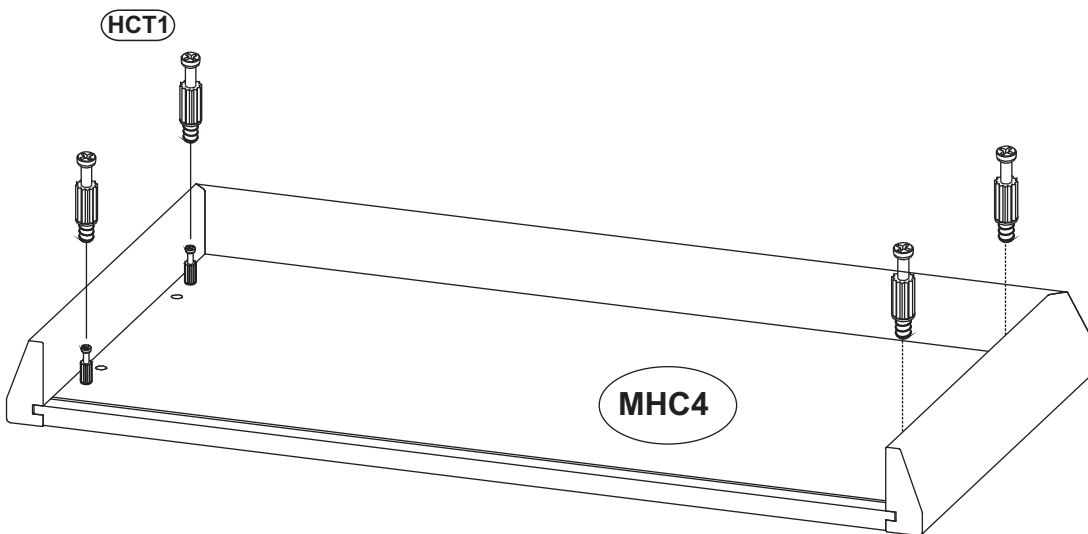
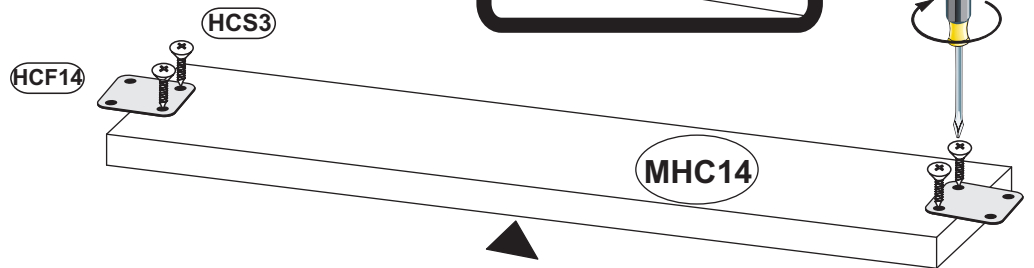
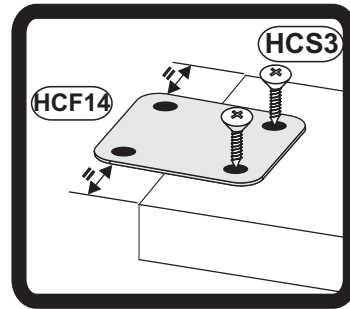
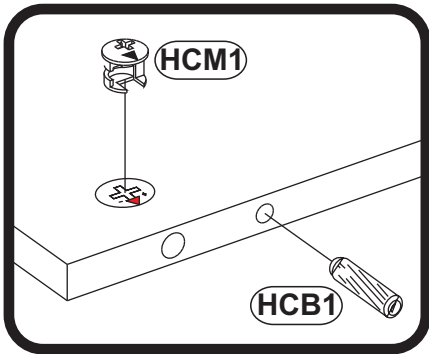

5

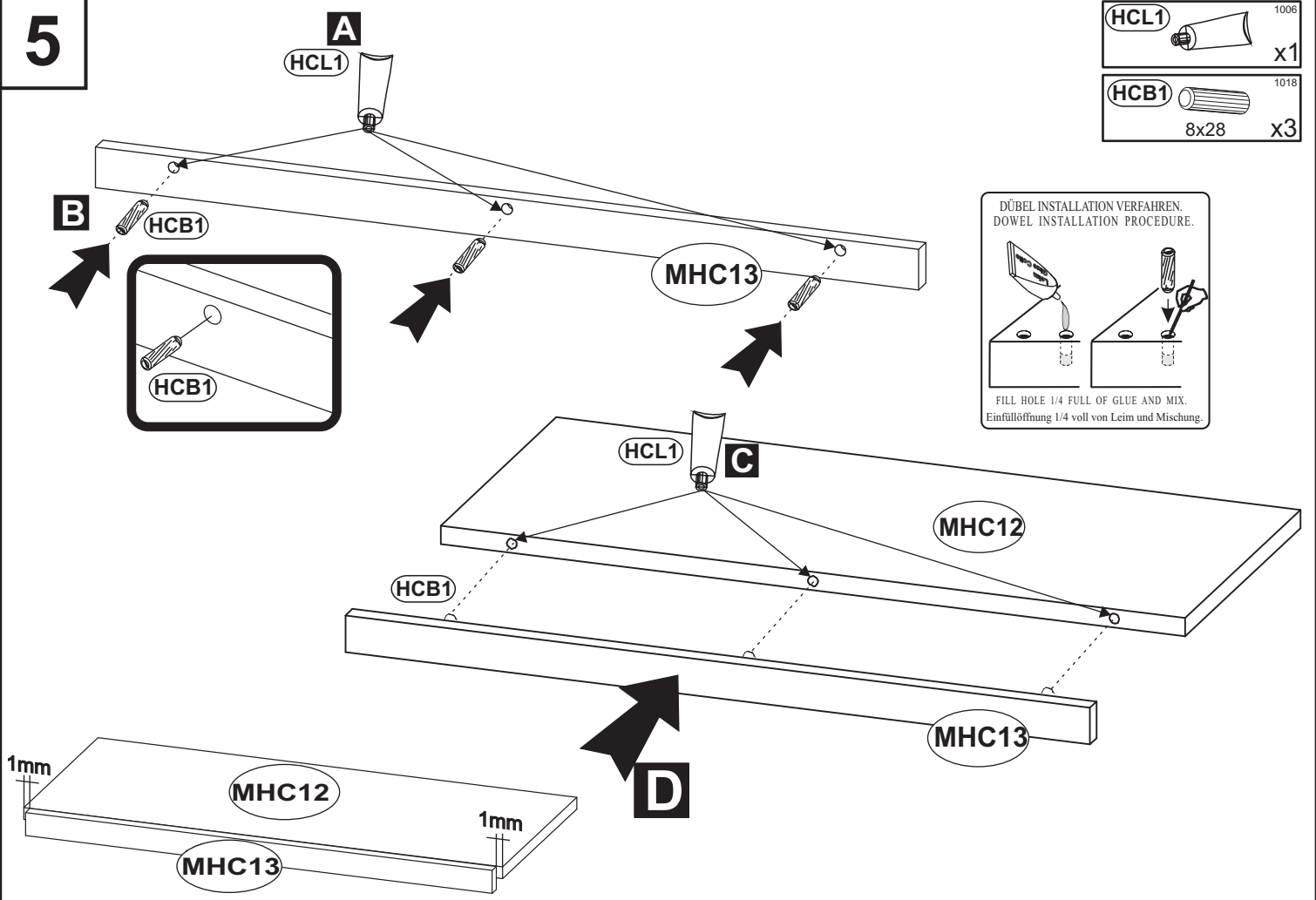

6

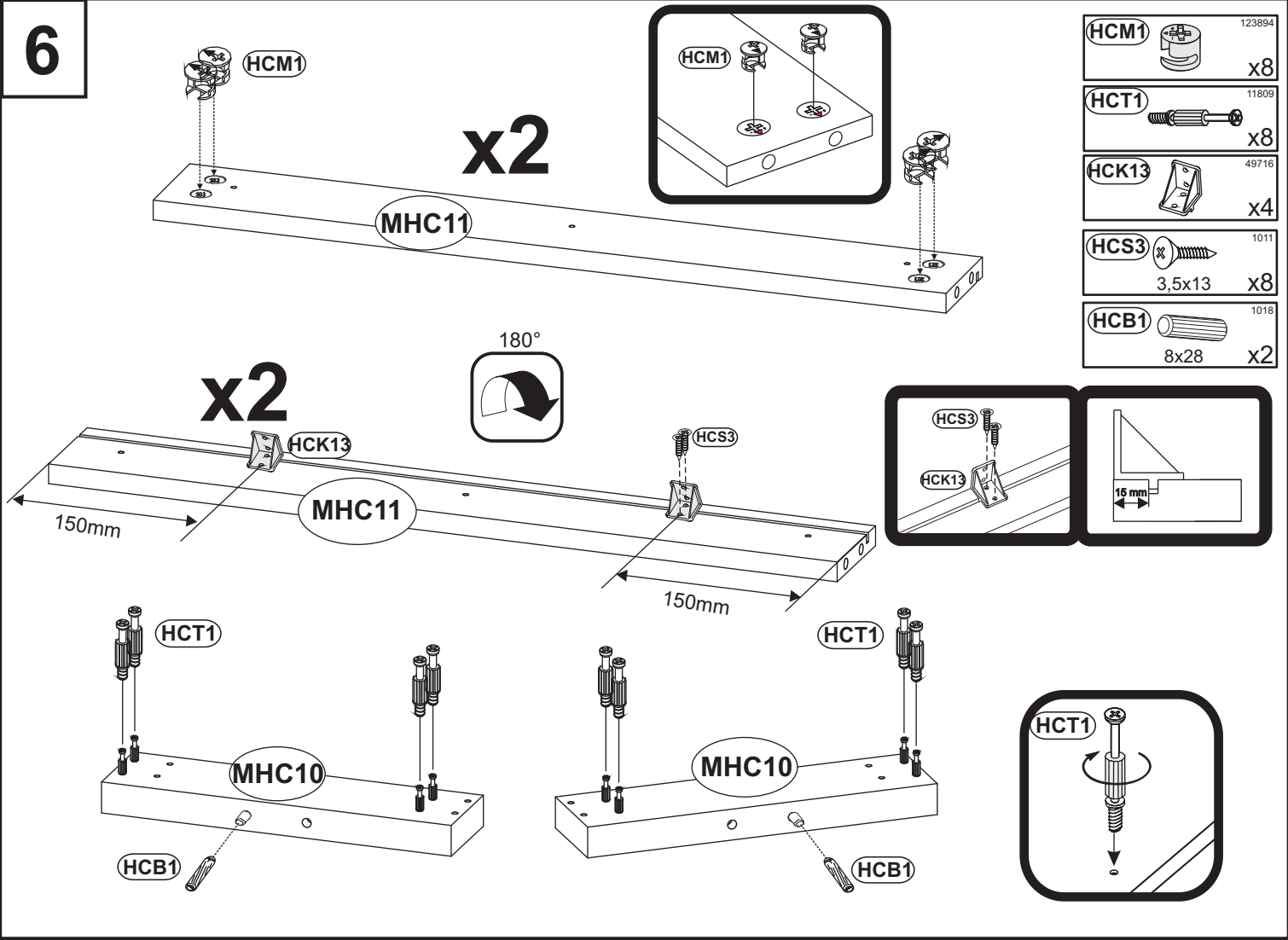

7

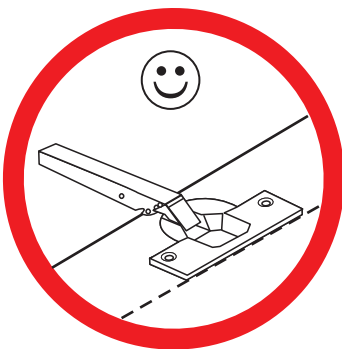
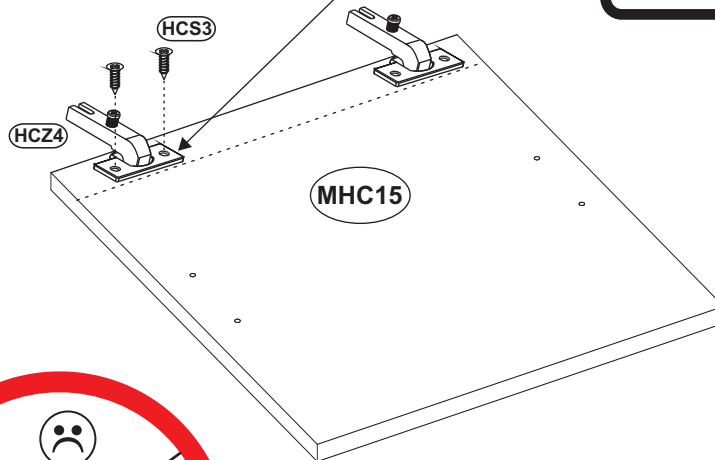
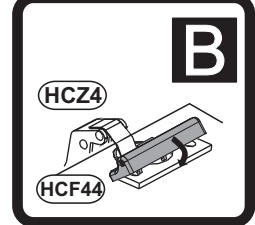
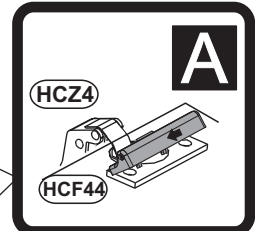
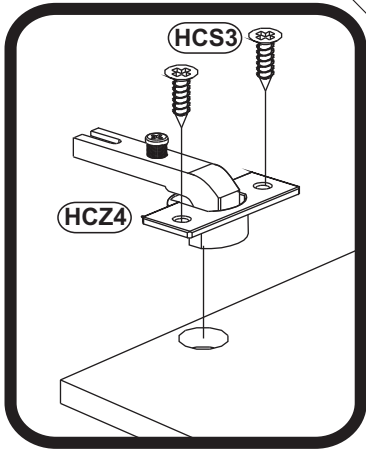
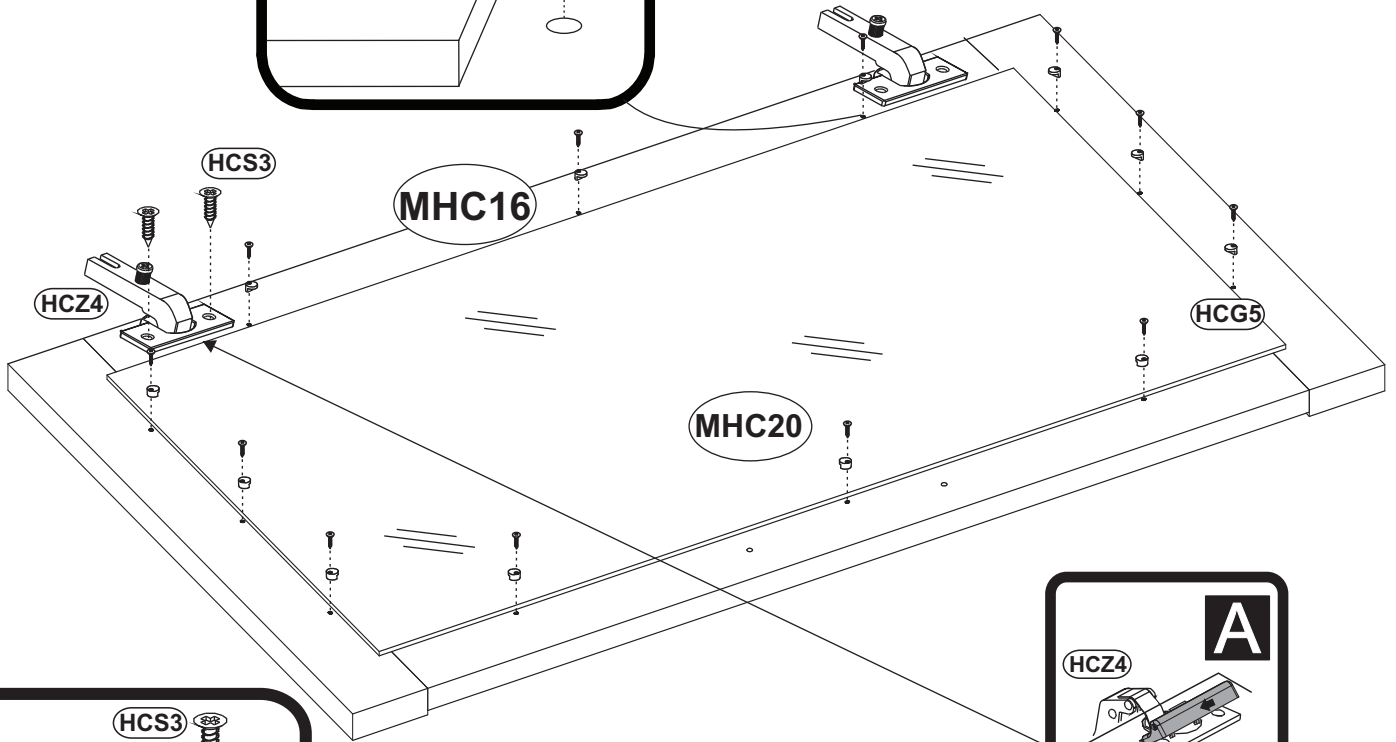
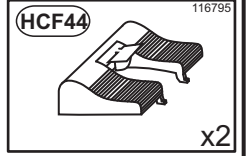
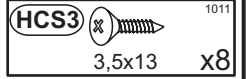
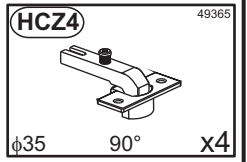
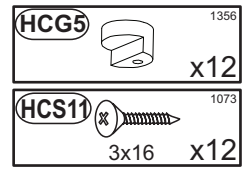
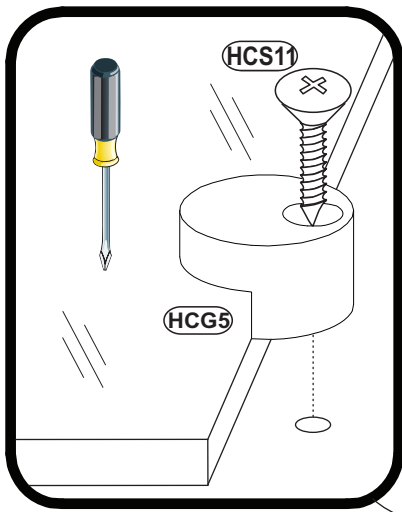



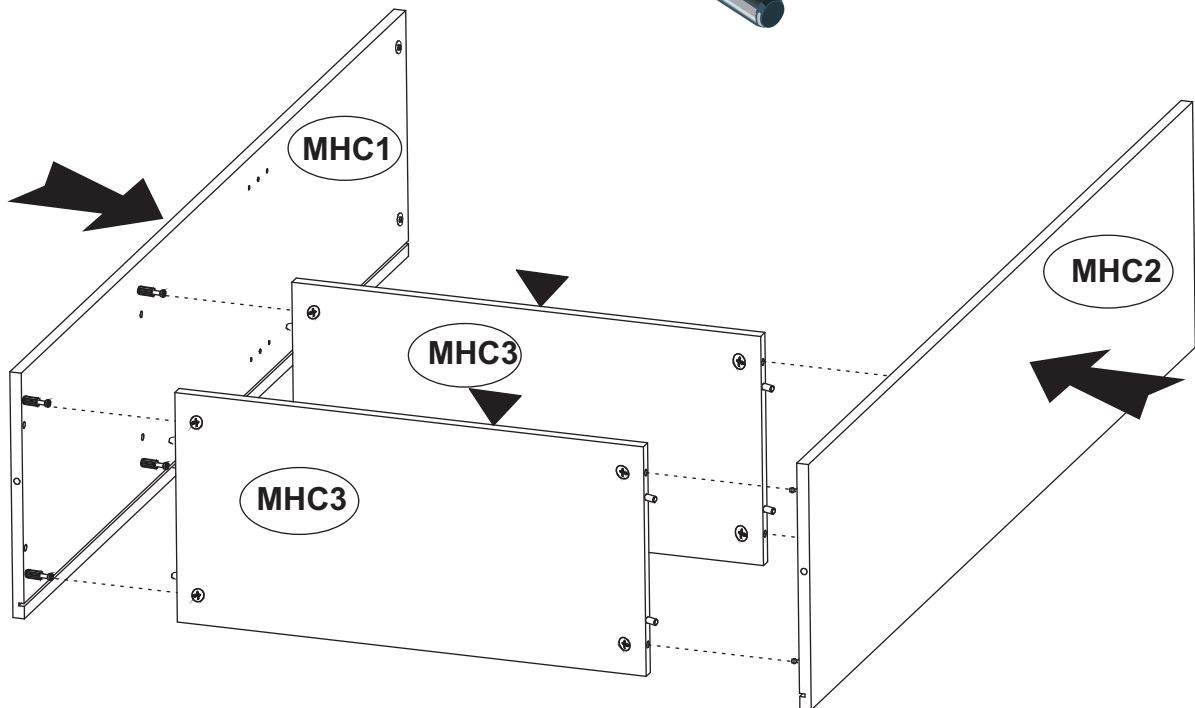
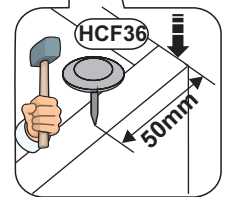
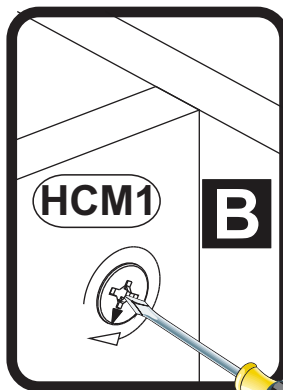
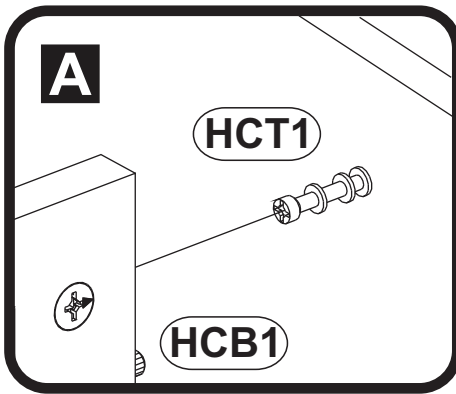
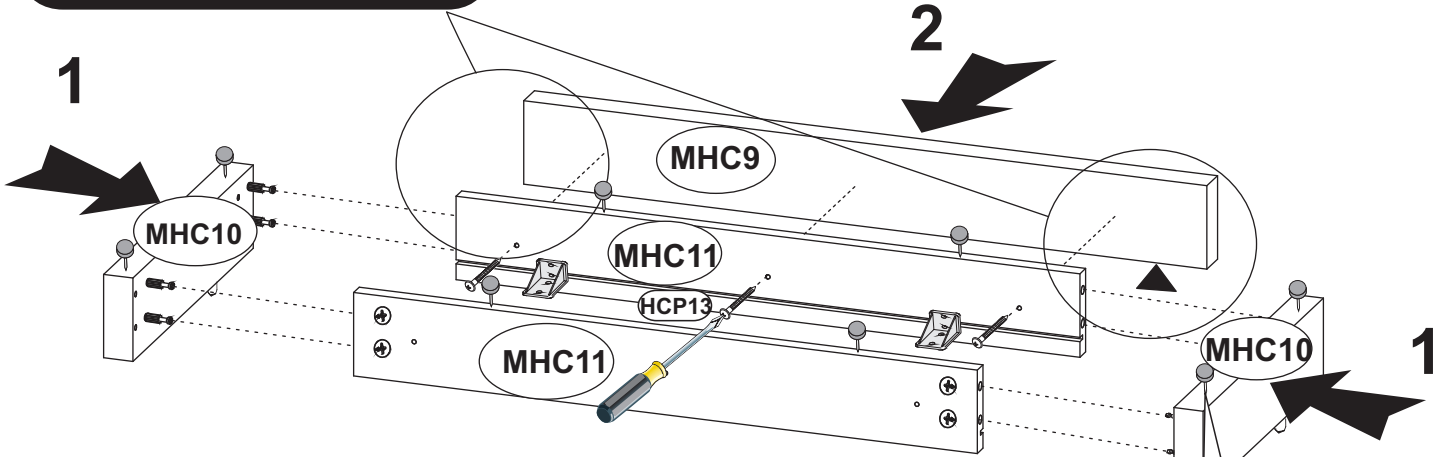
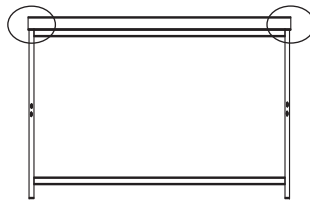
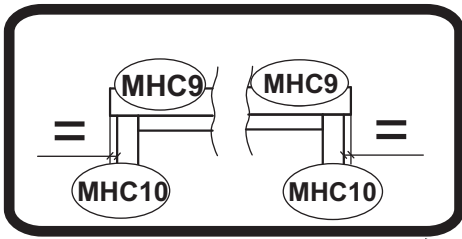

8

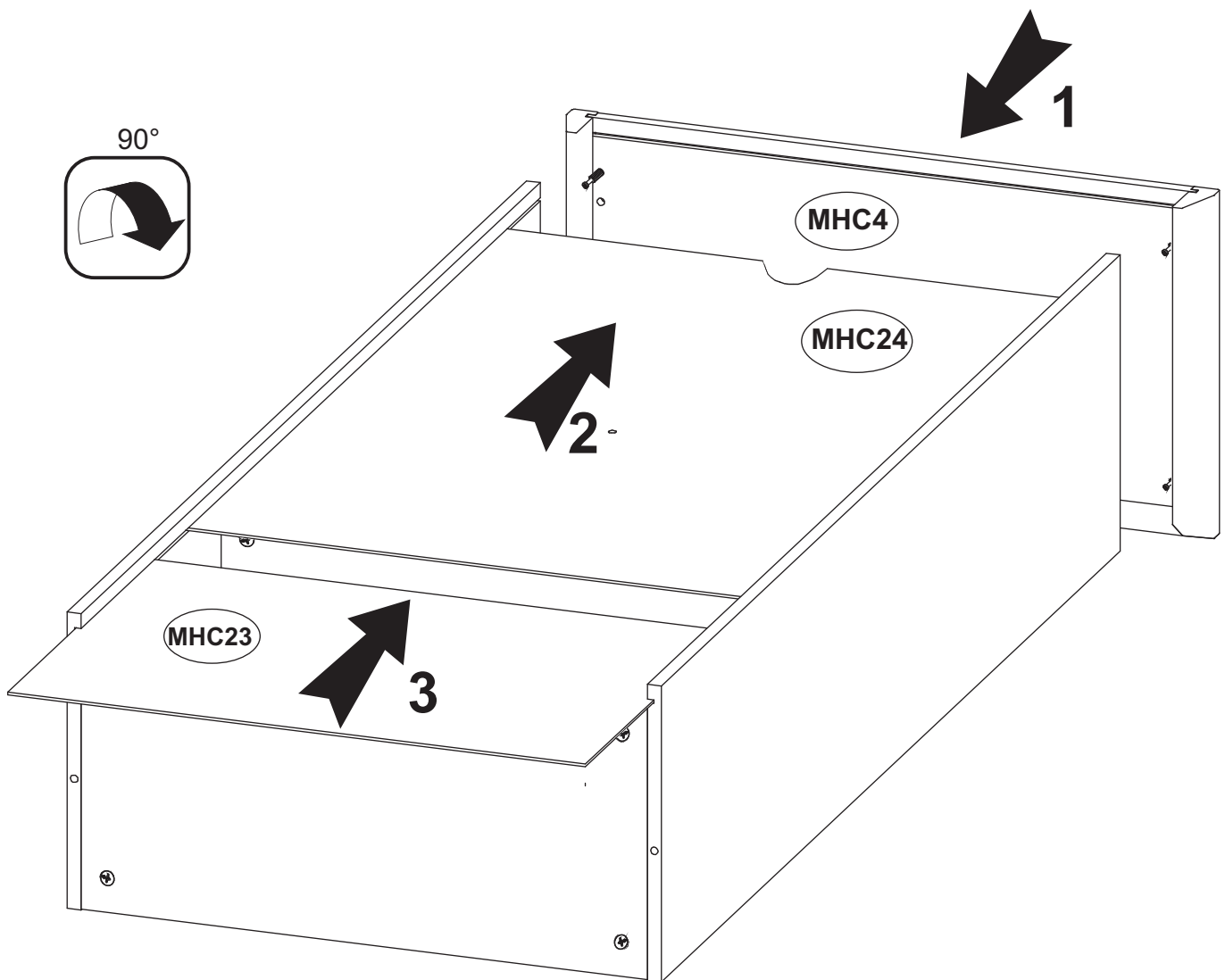
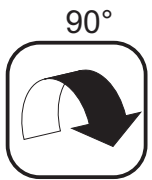
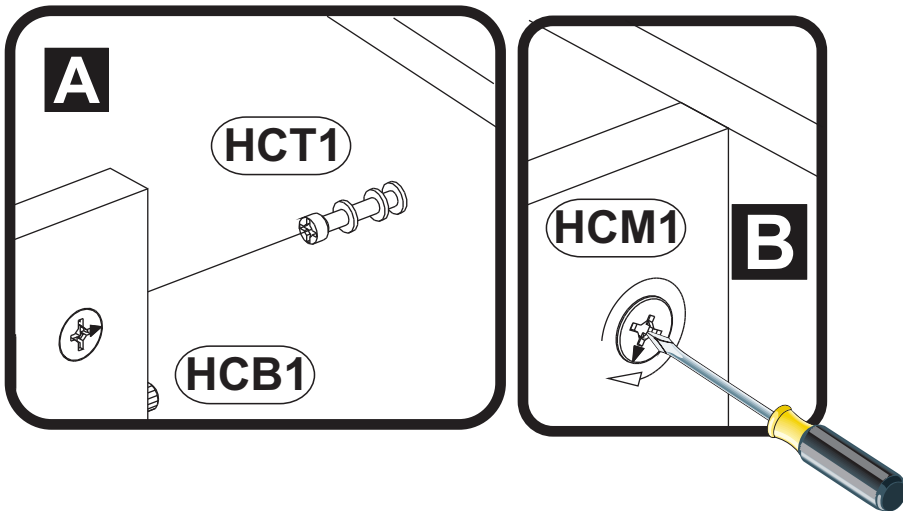
HCP13	1012
4x30	x3
HCF36	1305
	x8





HCP6		1056
	3x20	x8
HCJ23		1302
		x12
HCF1		1415
		x4
HCS3		1011
	3,5x13	x8

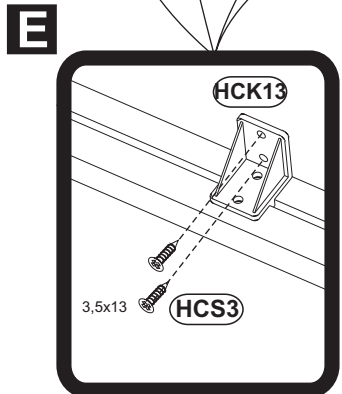
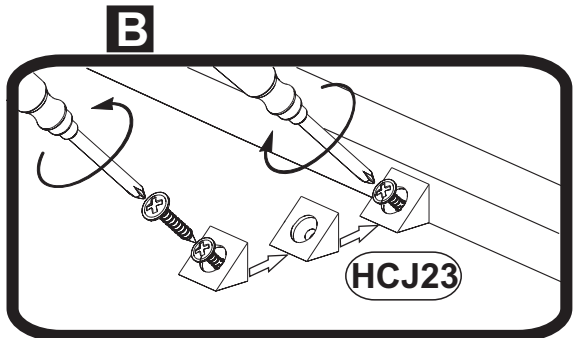
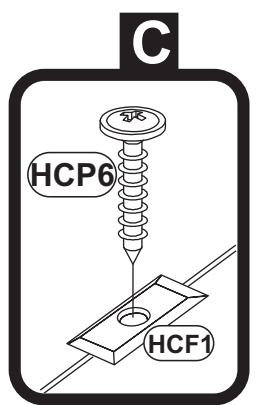
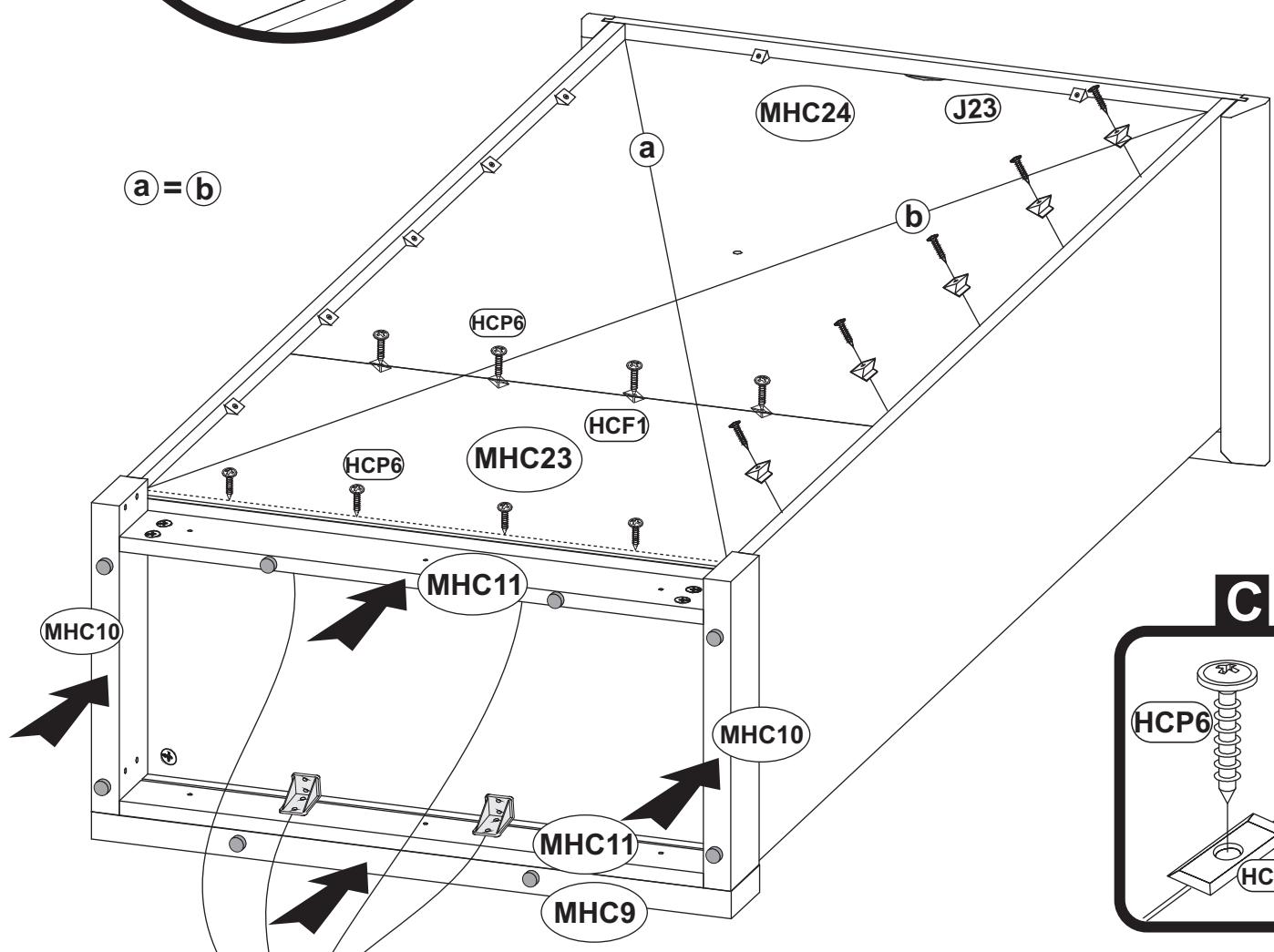
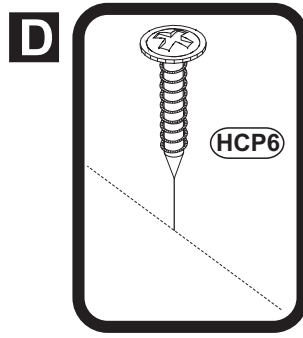
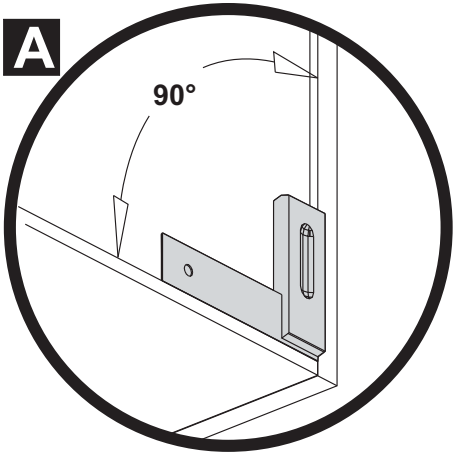

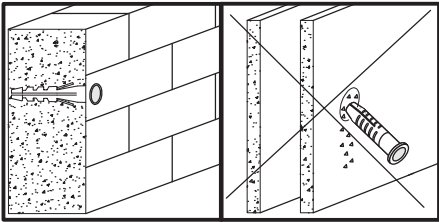

HCS3		1011
	3,5x13	x24
HCW1		1289
		x4
HCJ11		1267
		x1
HCC6		0000
	φ20	x8

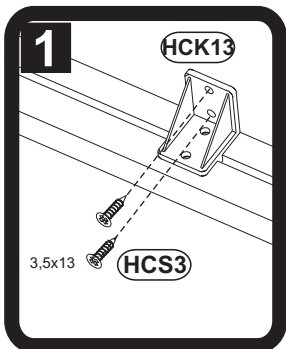
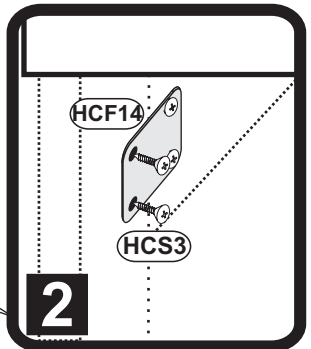
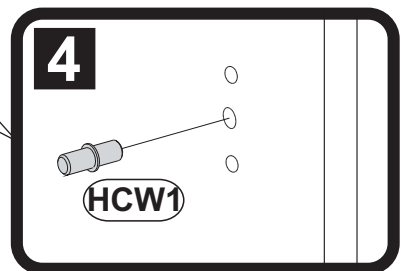
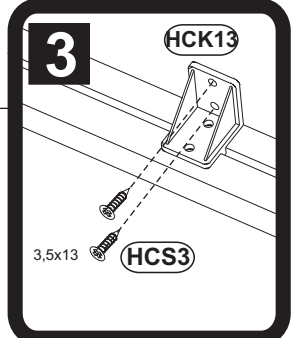
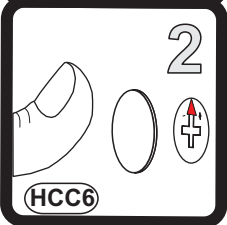
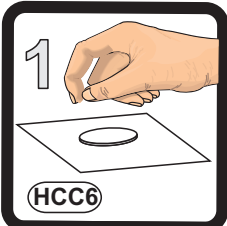
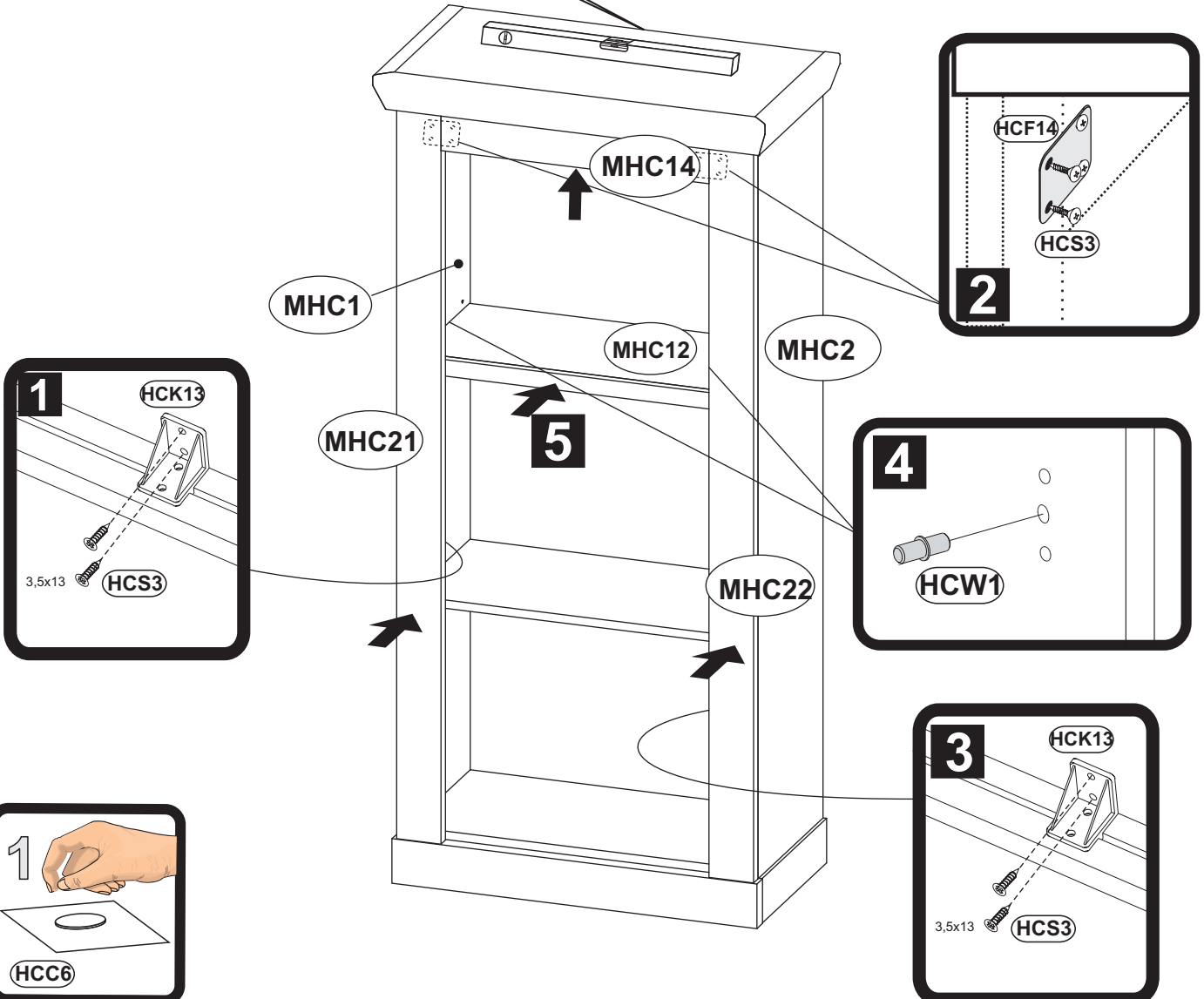
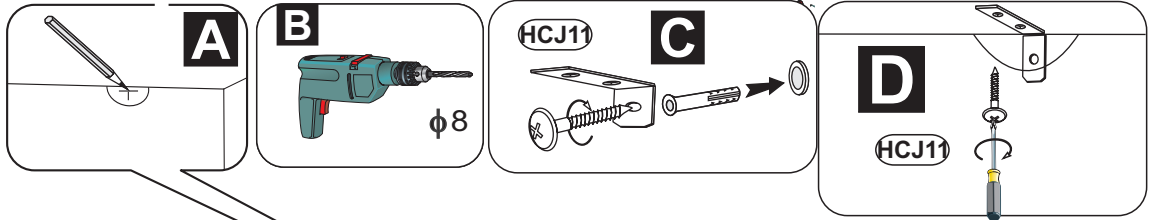

5

4

2

MHC1

MHC14

MHC12

MHC2

MHC21

MHC22

1

HCK13

3,5x13

HCS3

4

HCW1

3

HCK13

3,5x13

HCS3

1

HCC6

2

HCC6

OPTION L

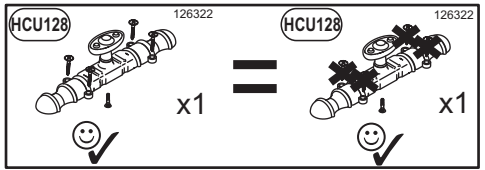
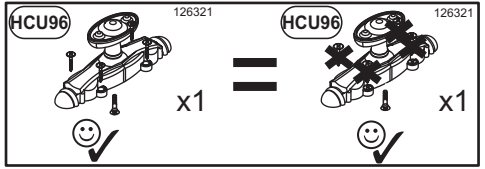
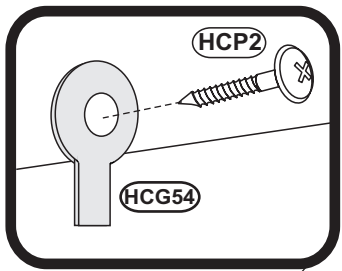

HCA6		2549
WPM 4x22		x4
HCG54		126680
		x1
HCP2		1014
3,5x13		x1

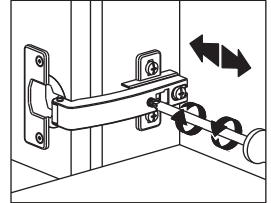
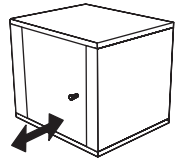
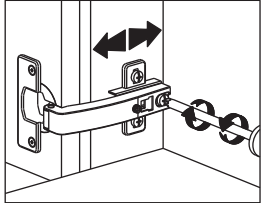
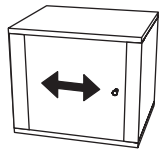
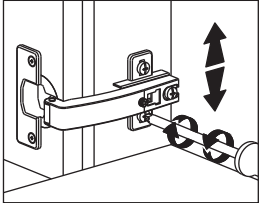
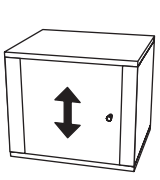
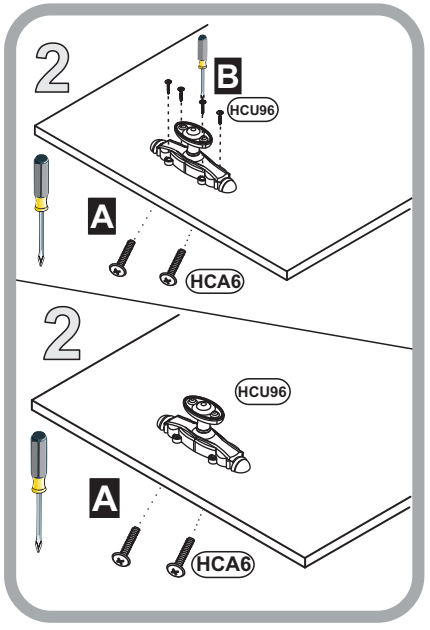
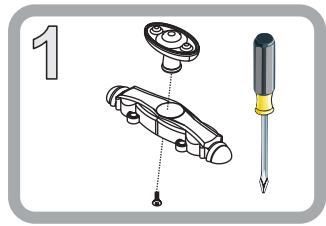
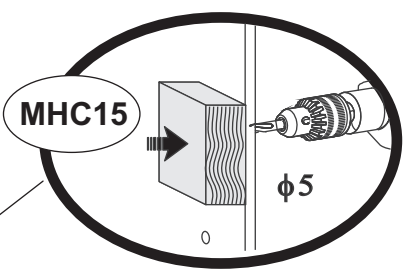
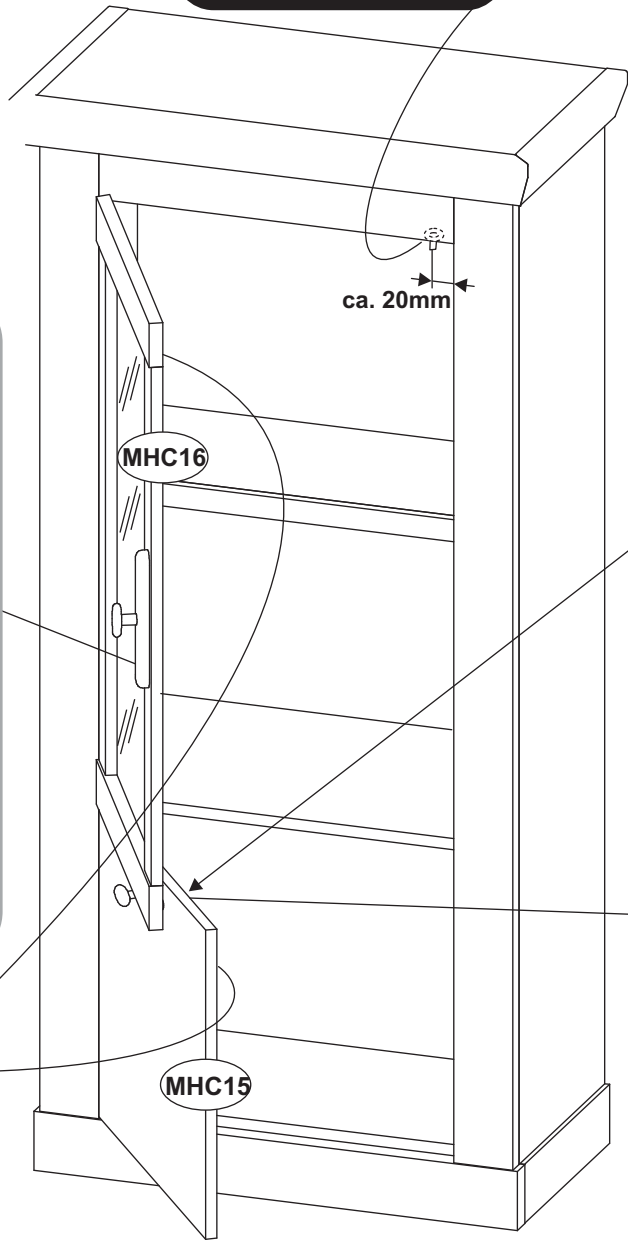
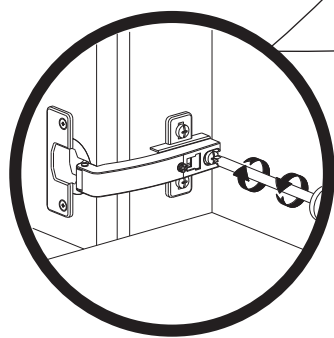
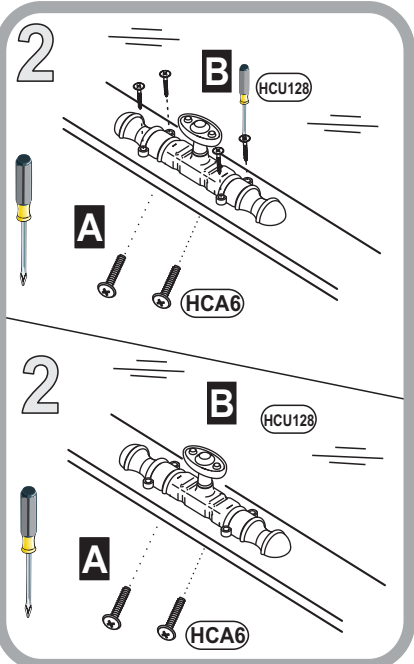
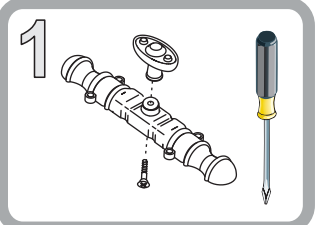

OPTION R

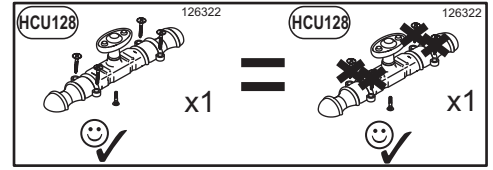
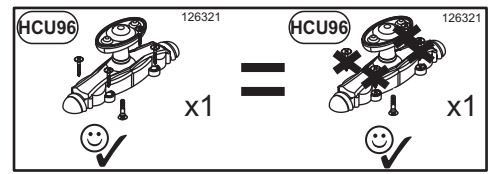
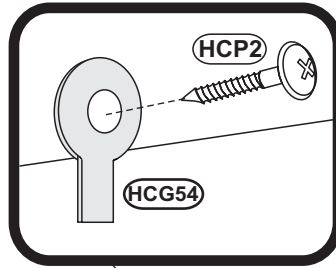

HCA6		2549
WPM 4x22		x4
HCG54		126680
		x1
HCP2		1014
3,5x13		x1

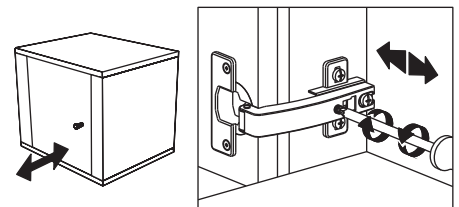
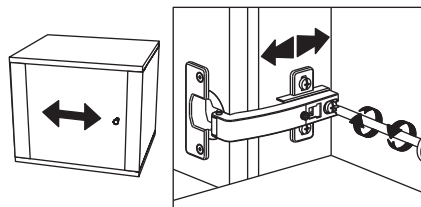
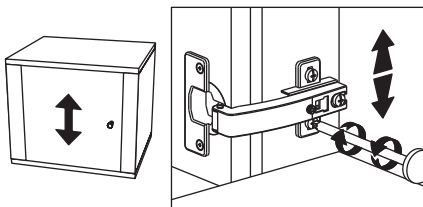
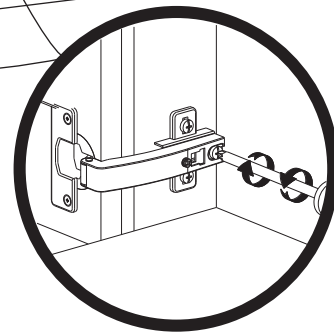
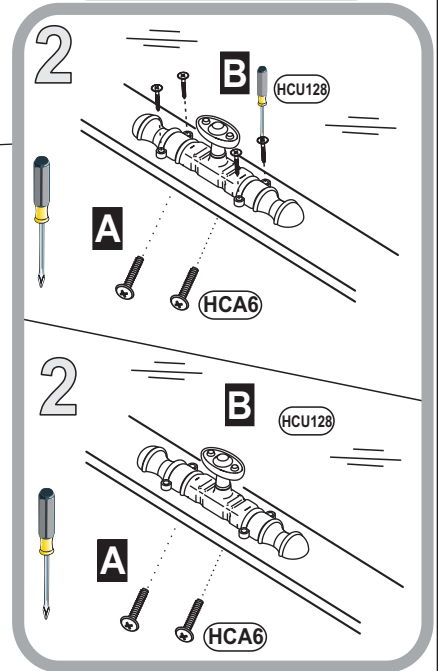
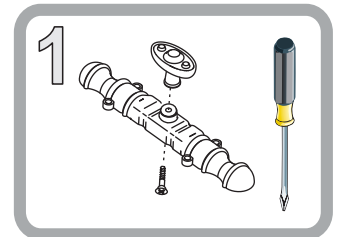
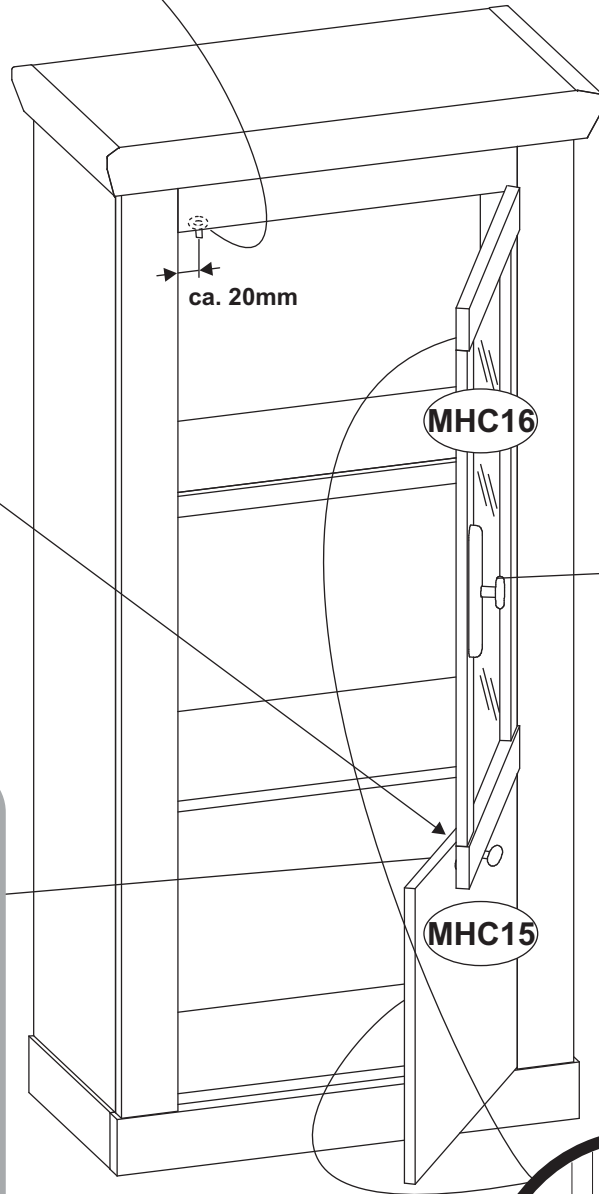
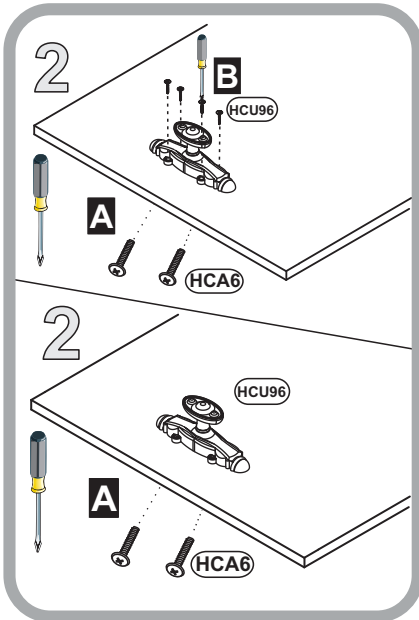
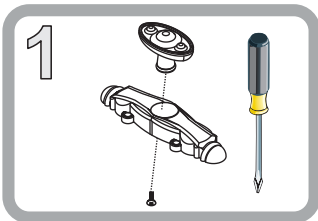
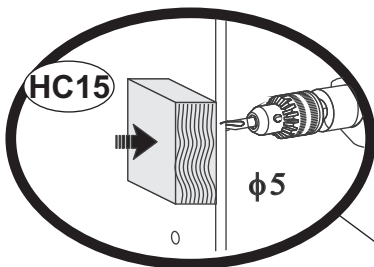

FLORENZ 22M

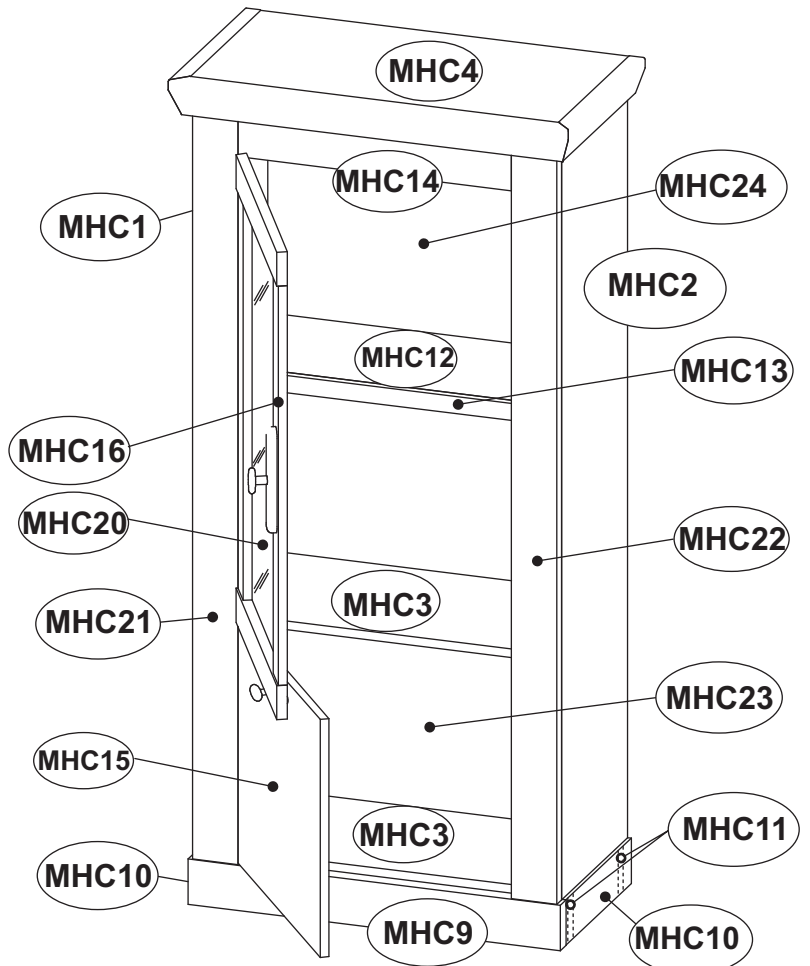
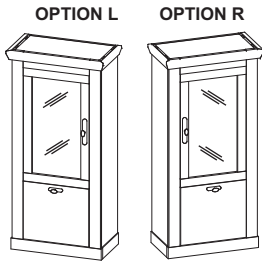

D Unser Direktservice für Beschlagteile
 Sollte Ihnen ein Beschlagteil fehlen, können Sie diese Servicekarte direkt an die untenstehende Adresse mailen. Wir können allerdings nur Beschlagteile auf diesem Wege verschicken. Sollten Sie eine andere Beanstandung an Ihrem Möbelstück haben, so wenden Sie sich bitte direkt an Ihr Möbelhaus.

GB Our direct order service for fitting
 If a fitting part is missing, you can e-mail this service card directly to the address below. However, we can only send fitting parts in this way. If you have any other cause for complaint concerning your item of furniture, please contact your furniture store directly.

CZ Naše přímé služby pro kování
 Chybí-li vám nějaký díl z kování, můžete tuto servisní kartu odeslat e-mailem přímo na níže uvedenou adresu. Touto cestou však můžeme zoslať jen díly kování. Pokud byste reklamovali jiný díl nábytku, obraťte se přímo na svého prodejce nábytku.

F Bien étudier la notice de montage
 S'il vous manque une ferrure, veuillez envoyer directement la présente carte service à l'adresse e-mail indiquée ci-dessous. Cependant, ceci nous permet uniquement d'envoyer des ferrures. Pour tout autre type de réclamation concernant votre meuble, veuillez contacter directement votre magasin d'ameublement.

I Il nostro servizio diretto per l'ordine della ferramenta
 Qualora Vi dovesse mancare un pezzo di fissaggio, allora Vi preghiamo di inviare questa carta di servizio immediatamente all'indirizzo sottostante. Possiamo inviare i pezzi di fissaggio solamente per mezzo di questo procedimento. Qualora dovete avere qualche altra reclamazione in merito al mobile, allora Vi preghiamo di rivolgerVi direttamente al Vostro Negozio di mobili.

BG Нашата директна услуга за обков
 Ако липсват части от комплекта, попълнете настоящата сервисна карта и ни я изпратете на e-mail адреса, посочен по-долу. По този начин можем да доставим само липсващи елементи от обкова. Ако уговорите други дефекти по мебелите, Ви съветваме да се обърнете към мебелната къща/магазин, от който сте закупили стоката.

NL Onze directservice voor losse onderdelen
 Wanneer er een onderdeel ontbreekt, kunt u deze servicekaart direct aan onderstaand e-mailadres sturen. Wij kunnen langs deze weg echter alleen beslagdelen versturen. Mocht u een ander probleem aan uw meubel hebben, verzoeken wij u contact op te nemen met uw meubeldealer.

PL Nasz bezpośredni serwis części montażowych
 Jeżeli brakuje części koniecznych do montażu, prosimy o przesłanie nam niniejszej karty serwisowej na niżej podany adres e-mailowy. W ten sposób możemy przesłać Państwu tylko brakujące części. W przypadku innych reklamacji dotyczących mebla, prosimy zgłosić się do salonu meblowego, w którym został dokonany zakup.

HR Servis za okove
 U slučaju da nedostaje neki od dijelova molimo vas da na dolje navedenu mail adresu pošaljete ovaj servisni obrazac. Na ovaj način mogu se dostaviti samo okovi. U slučaju da imate dodatne prigovore vezane uz komad namještaja molimo vas da se obratite izravno trgovini namještaja gdje je isti kupljen.

HU Direktszolgálatunk vasalatók esetén
 Ha hiányzik egy vasalat, ezt a kártyát közvetlenül elküldheti az alább található címre. Azonban csak vasalatókat tudunk így küldeni. Amennyiben másfajta reklamáció áll fenn bútordarabját illetően, forduljon közvetlenül a bútórárházhoz.

SK Naš priamy servis pre časti kovania
 Ak by Vám chýbala nejaká časť kovania, môžete poslať túto servisnú kartu poslať e-mailom na nižšie uvedenú adresu. Diely kovania vieme poslať iba týmto spôsobom. Ak by ste mali inú reklamáciu ohľadom Vášho nábytku, obraťte sa priamo na Vašu predajňu nábytku.

SLO Naše direktno uslužne storitve za okovje
 Če vam manjka kakšno okovje, lahko to servisno kartico pošljete po e-pošti direktno na spodnji naslov. Po tej poti vam lahko pošljemo samo okovje. Če želite reklamirati kakšen drug del pohištva, se obrnite neposredno na vašo trgovino pohištva.

RO Service-ul nostru direct pentru feronerie
 In cazul in care va lipseste o piesa de feronerie puteti să trimiteti direct acest card de service prin e-mail la adresa de mai jos. Noi nu putem expedia piese de feronerie decât pe această cale. Dacă aveți o altă reclamație referitoare la piesa de mobilier, atunci vă rugăm să vă adresați direct la magazinul dvs. de mobilă.

RUS Наш прямой сервис для поставок фурнитуры
 Если окажется, что Вам не хватает того или иного элемента фурнитуры, Вы можете отправить сервисную карту по факсу непосредственно на нижеприведенный адрес электронной почты. Однако, таким образом мы можем пересылать лишь фурнитуру. Если же у Вас возникнут иные претензии относительно приобретенной мебели, пожалуйста, обращайтесь непосредственно в организацию, осуществившую продажу.

S Vår direktservice för beslagdelar
 Om du saknar en beslagdel kan du skicka detta servicekort direkt till e-postadressen som anges nedan. Tänk på att detta är den enda möjligheten att skicka beslagdelar till dig. Om du vill reklamera din möbel av en annan anledning måste du kontakta ditt möbelfhus direkt.

ES Nuestro servicio directo para accesorios
 Si le falta algún accesorio, puede enviar esta tarjeta de servicio directamente a la siguiente dirección. No obstante, por este método solo podemos enviar accesorios. Si tiene alguna otra objeción sobre su mueble, consulte directamente con su mueblería.

TR Donatılar için doğrudan servisimiz
 Bir donatınız eksikse bu servis kartını doğrudan aşağıda bulunan adrese doğrudan mail yazabilirsiniz. Sadece bu yolla donatıları gönderebiliriz. Mobilyanızda başka şikayetleriniz varsa lütfen doğrudan mobilya satıcınıza danışın.

MHC1	1361	320	15	1/1
MHC2	1361	320	15	1/1
MHC3	611	299	15	1/1
MHC4	699	370,5	65	1/1
MHC9	655	80	28	1/1
MHC10	317	80	28	1/1
MHC11	598	80	15	1/1
MHC12	610	267	15	1/1
MHC13	608	30	16	1/1
MHC14	483	120	18	1/1

MHC15	419	477	15	1/1
MHC16	813	477	18	1/1
MHC20	723	386	4	1/1
MHC21	1361	80	22	1/1
MHC22	1361	80	22	1/1
MHC23	421	623	3	1/1
MHC24	945	623	3	1/1

FLORENZ 22M

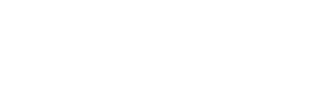
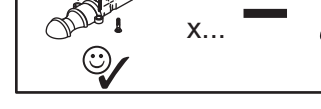
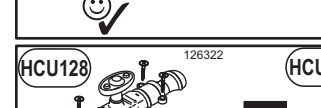
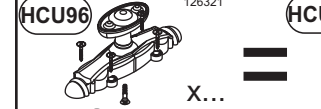
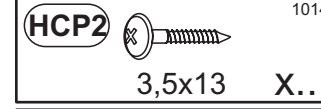
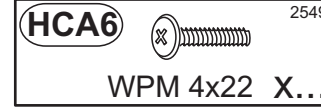
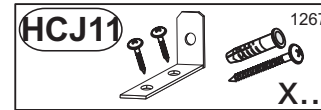
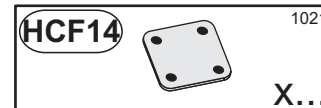
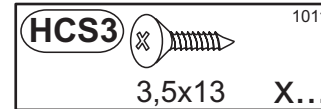
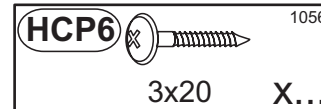
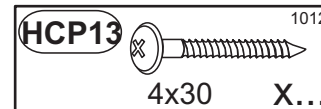
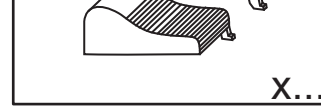
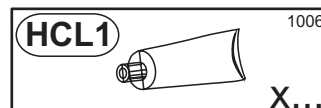
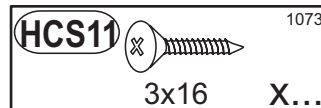
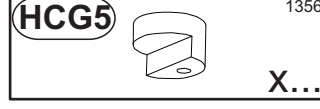
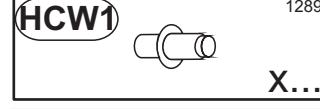
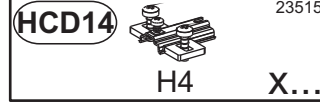
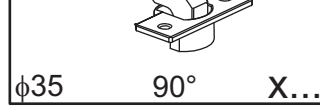
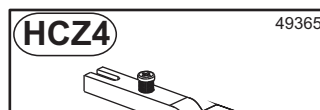
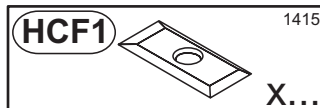
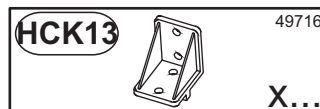
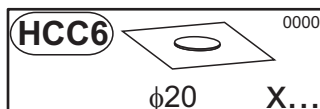
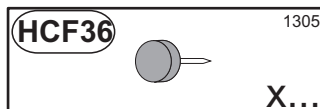
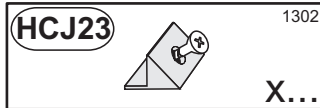
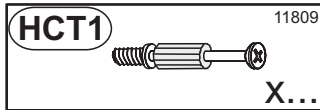
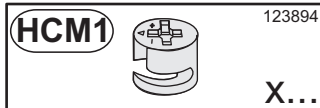
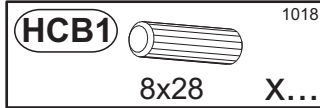

D Unser Direktservice für Beschlagteile
Sollte Ihnen ein Beschlagteil fehlen, können Sie diese Servicekarte direkt an die untenstehende Adresse mailen. Wir können allerdings nur Beschlagteile auf diesem Wege verschicken. Sollten Sie eine andere Beanspruchung an Ihrem Möbelstück haben, so wenden Sie sich bitte direkt an Ihr Möbelhaus.

GB Our direct order service for fitting
If a fitting part is missing, you can e-mail this service card directly to the address below. However, we can only send fitting parts in this way. If you have any other cause for complaint concerning your item of furniture, please contact your furniture store directly.

CZ Naše přímé služby pro kování
Chybí-li vám nějaký díl z kování, můžete tuto servisní kartu odeslat e-mailem přímo na níže uvedenou adresu. Touto cestou však můžeme zrealizovat jen díly kovány. Pokud byste reklamovali jiný díl nábytku, obraťte se přímo na svého prodejce nábytku.

F Bien étudier la notice de montage
Si l'un des éléments de montage manque, veuillez envoyer directement la présente carte service à l'adresse e-mail indiquée ci-dessous. Cependant, ceci nous permet uniquement d'envoyer des ferrures. Pour tout autre type de réclamation concernant votre meuble, veuillez contacter directement votre magasin d'ameublement.

I Il nostro servizio diretto per l'ordine della ferramenta
Qualora Vi dovesse mancare un pezzo di fissaggio, allora Vi preghiamo di inviare questa carta di servizio immediatamente all'indirizzo sottostante. Possiamo inviare i pezzi di fissaggio solamente per mezzo di questo procedimento. Qualora doveste avere qualche altra reclamazione in merito al mobile, allora Vi preghiamo di rivolgerVi direttamente al Vostro Negozio di mobili.

BG Нашата директна услуга за обкова
Ако липсват части от комплекта, попълнете настоящата сервисна карта и ни я изпратете на e-mail адреса, посочен по-долу. По този начин можем да доставяме само липсващи елементи от обкова. Ако установите други дефекти по мебелите, Ви съветваме да се обърнете към мебелната къща/магазин, от който сте закупили стоката.

NL Onze directservice voor losse onderdelen
Wanneer er een onderdeel ontbreekt, kunt u deze servicekaart direct aan onderstaand e-mailadres sturen. Wij kunnen langs deze weg echter alleen beslagdelen versturen. Mocht u een ander probleem aan uw meubel hebben, verzoekten wij u contact op te nemen met uw meubeldealer.

PL Nasz bezpośredni serwis czeski montażowych
Jeżeli brakuje części koniecznych do montażu, prosimy o przesłanie nam niniejszej karty serwisowej na niżej podany adres e-mailowy. W ten sposób możemy przesyłać Państwu tylko brakujące części. W przypadku innych reklamacji dotyczących mebla, prosimy zgłosić się do salonu meblowego, w którym został dokonany zakup.

HR Servis za okove
U slučaju da nedostaje neki od dijelova molimo vas da na dolje navedenu mail adresu pošaljete ovaj servisni obrazac. Na ovaj način mogu se dostaviti samo okovi. U slučaju da imate dodatne prigovore vezane uz komad namještaja molimo vas da se obratite izravno trgovini namještaja gdje je isti kupljen.

HU Direktszolgálatunk vasalatok esetén
Ha hiányzik egy vasalat, ezt a kártyát közvetlenül elküldheti az alább található címre. Azonban csakis vasalatoskat tudunk így küldeni. Amennyiben másfajta reklamációt áll fenn bútordarabját illetően, forduljon közvetlenül a bútorházához.

SK Naš priamy servis pre časti kovania
Ak by Vám chýbala nejaká časť kovania, môžete poslať túto servisnú kartu poslať e-mailom na nižšie uvedenú adresu. Dieľo kovania vieme poslať iba týmto spôsobom. Ak by ste mali inú reklamáciu ošhadom Vašho nábytku, obráťte sa priamo na Vašu predajňu nábytku.

SLO Če vam manjka kakšno okovje, lahko to servisno kartico pošljete po e-pošti direktno na spodnji naslov. Po tej poti vam lahko pošljemo samo okovje. Če želite reklamirati kakšen drug del pohištva, se obrnite neposredno na vašo trgovino pohištva.

RO Service-ul nostru direct pentru feronerie
In cazul în care vă lipsește o piesă de feronerie puteți să trimiteți direct acest card de service prin e-mail la adresa de mai jos. Noi nu putem expedia piese de feronerie decât pe această cale. Dacă aveți o altă reclamație referitoare la piesa de mobilier, atunci vă rugăm să vă adresati direct la magazinul dvs. de mobilier.

RUS Наш прямой сервис для поставок фурнитуры
Если ожидается, что Вам не хватает того или иного элемента фурнитуры, Вы можете отправить сервисную карту по факсу непосредственно на нижеприведенный адрес электронной почты. Однако, таким образом мы можем переслать лишь фурнитуру. Если же у Вас возникнут иные претензии относительно приобретенной мебели, пожалуйста, обращайтесь непосредственно в организацию, осуществлявшую продажу.

S Vi direktservice för beslagsdelar
Om du saknar en beslagsdel kan du skicka detta servicekort direkt till e-postadressen som anges nedan. Tänk på att detta är den enda möjligheten att skicka beslagsdelar till dig. Om du vill reklamera din möbel av en annan anledning måste du kontakta ditt möbelhus direkt.

ES Nuestro servicio directo para accesorios
Si le falta algún accesorio, puede enviar esta tarjeta de servicio directamente a la siguiente dirección. No obstante, por este método solo podemos enviar accesorios. Si tiene alguna otra objeción sobre su mueble, consulte directamente con su mueblería.

TR Donatılar için doğrudan servisimiz
Bir donatınız eksikse bu servis kartını doğrudan aşağıda bulunan adrese doğrudan mail yazabilirsiniz. Sadece bu yolla donatılar gönderiliriz. Mobilyanızda başka şikayetleriniz varsa lütfen doğrudan mobilya satıcınıza danışın.

FLORENZ 31M

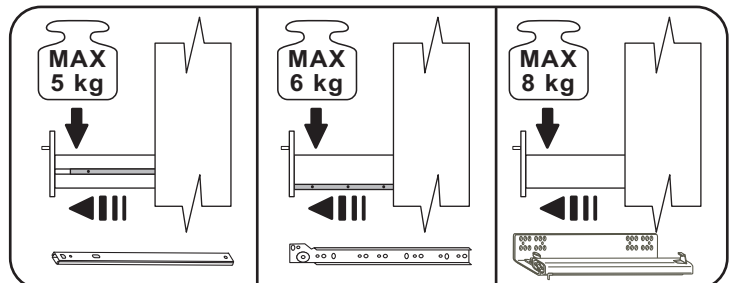
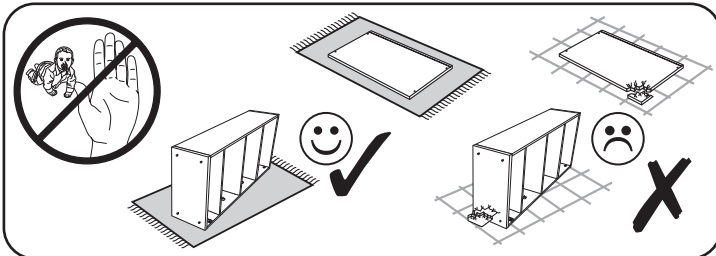
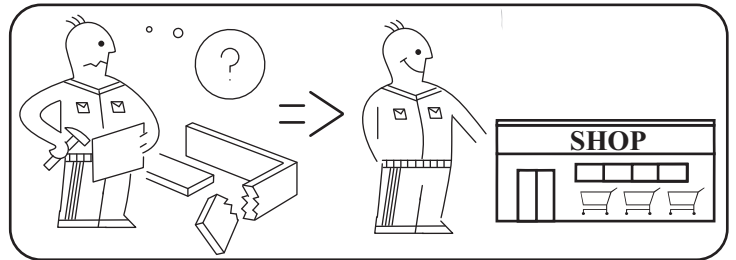
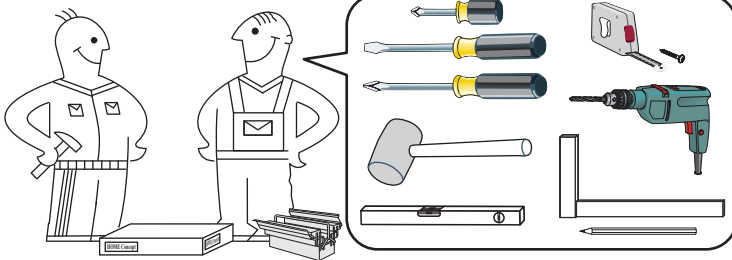
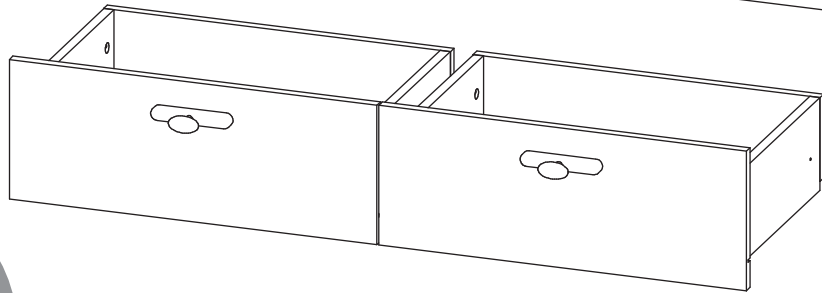
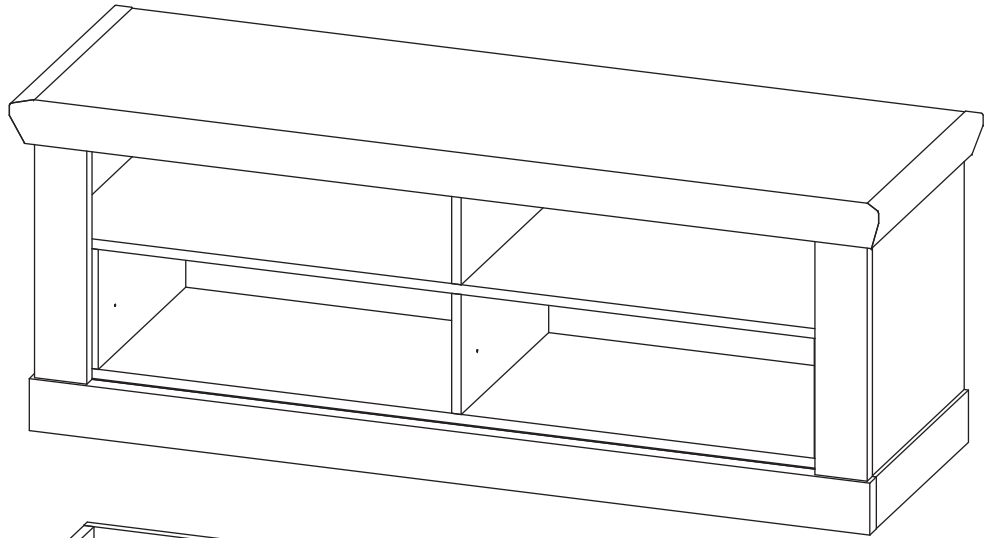
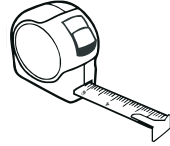
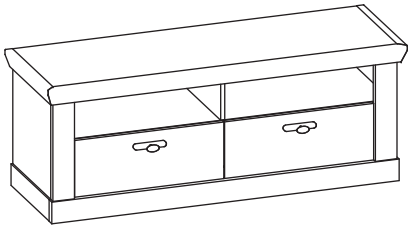

FLORENZ 31M

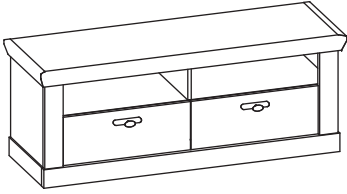

max.



MHC3

MHC4

max.



MHC8

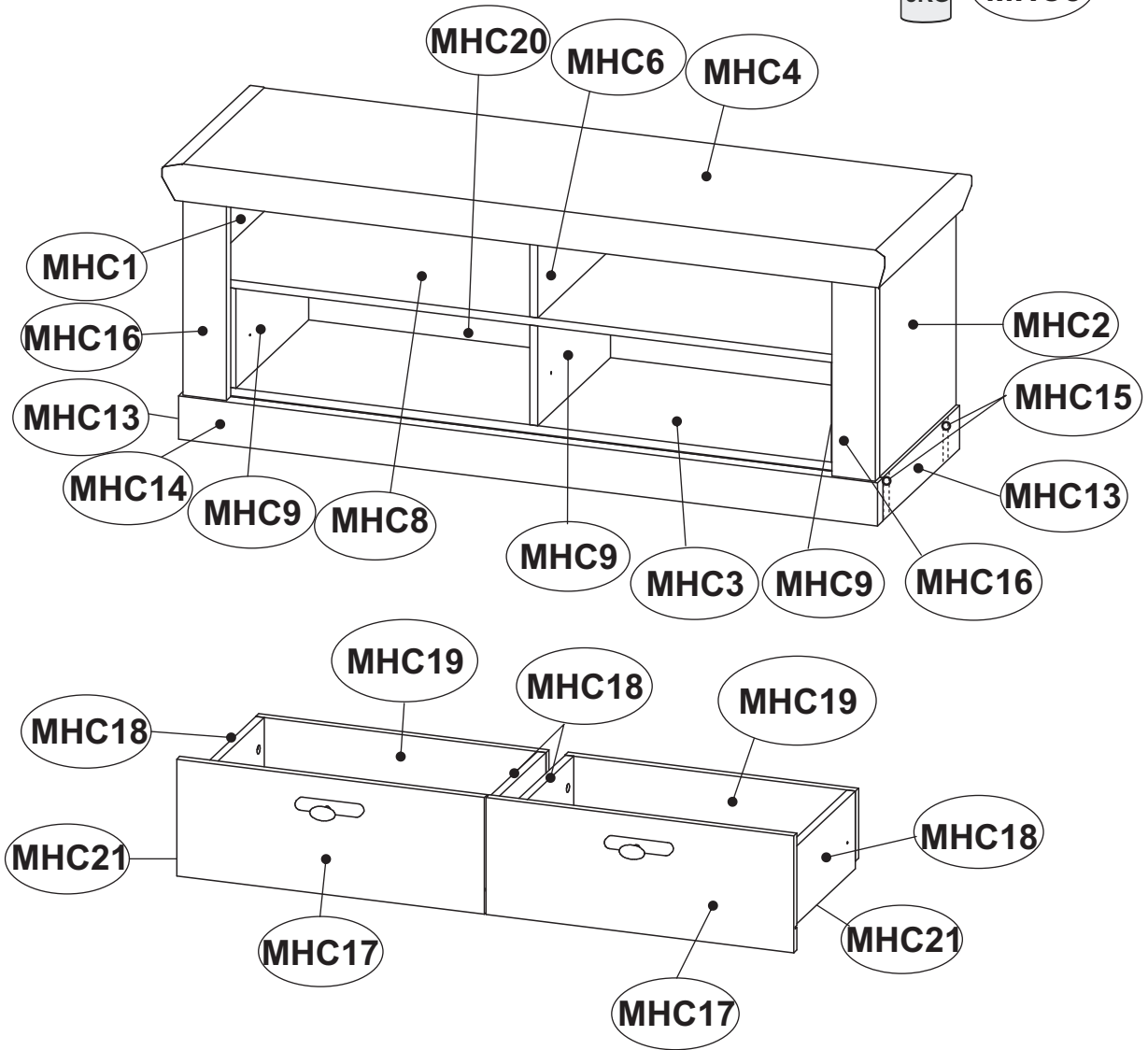



MHC1	411	389	15	1/1
MHC2	411	389	15	1/1
MHC3	1244	368	15	1/1
MHC4	1332	439,5	65	1/1
MHC6	196	367	15	1/1
MHC8	1244	368	15	1/1
MHC9	185	368	15	1/1
MHC13	386	80	28	1/1
MHC14	1288	80	28	1/1
MHC15	1231	80	15	1/1

MHC16	411	80	22	1/1
MHC17	553	210	15	1/1
MHC18	332	140	15	1/1
MHC19	522	126	15	1/1
MHC20	1256	416	3	1/1
MHC21	503	354	3	1/1

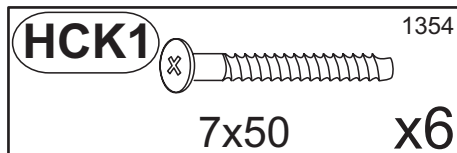
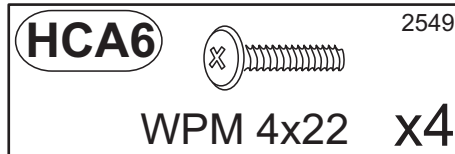
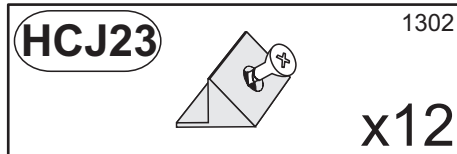
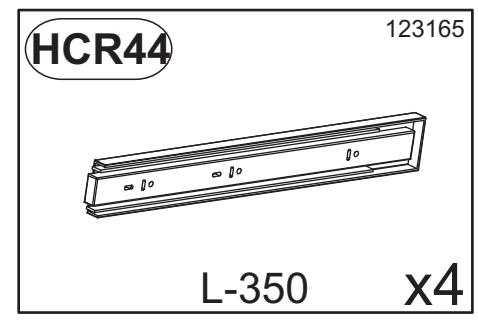
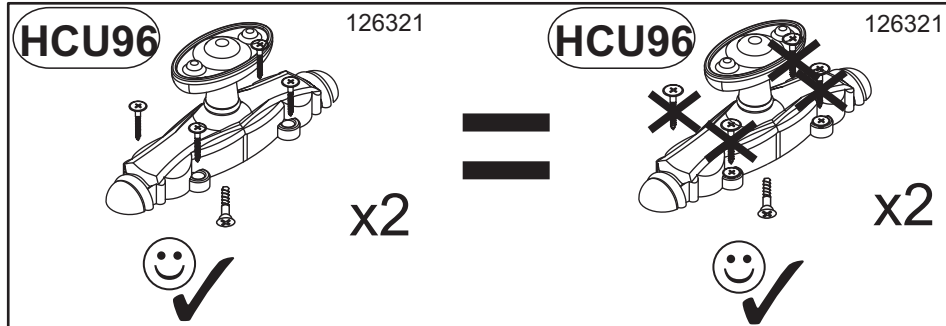
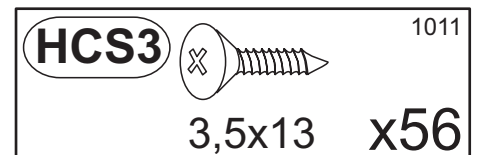
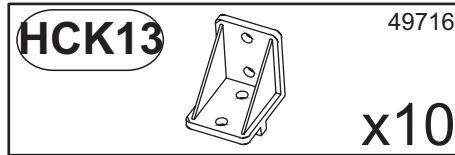
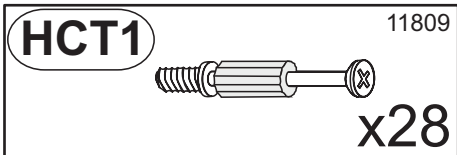
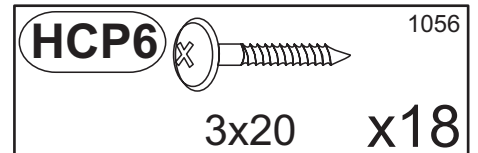
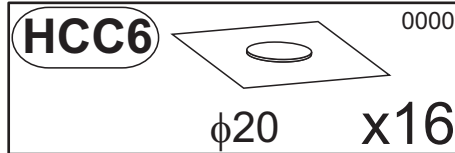
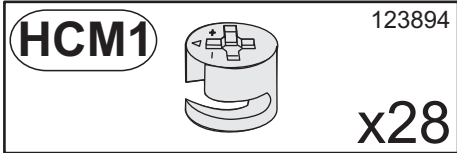
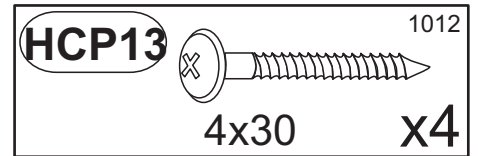
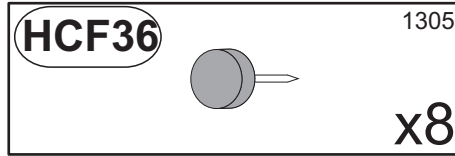
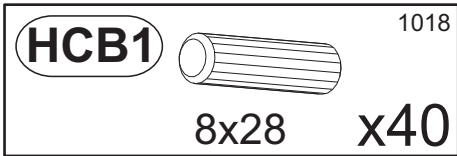
FLORENZ 31M

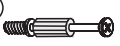

1

HCB1		1018
	8x28	x16
HCM1		123894
		x8
HCT1		11809
		x8

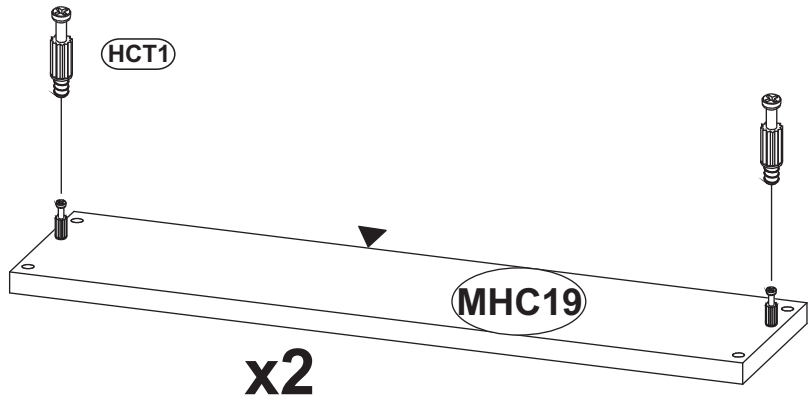
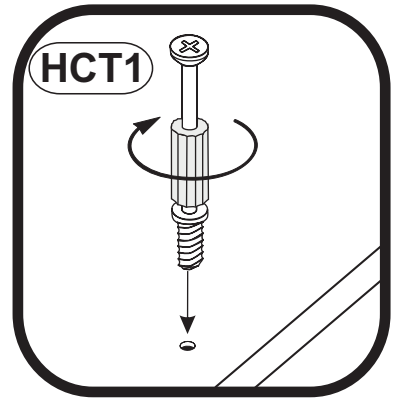
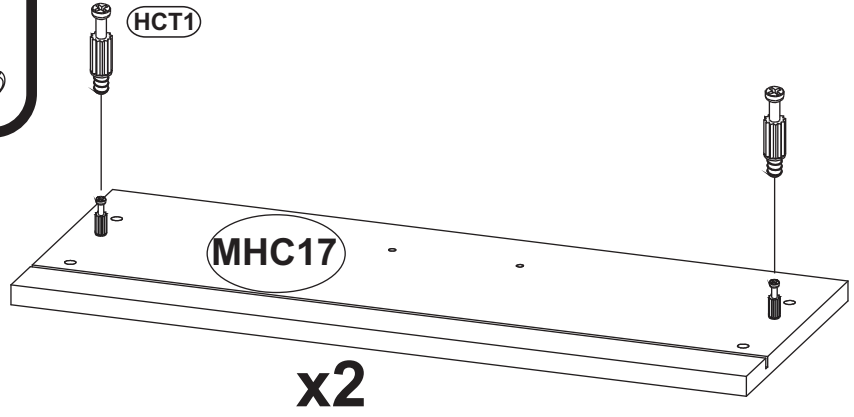
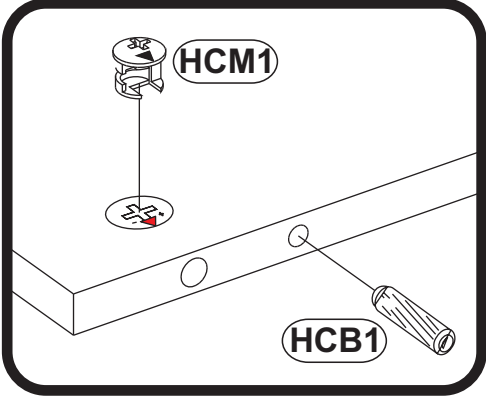
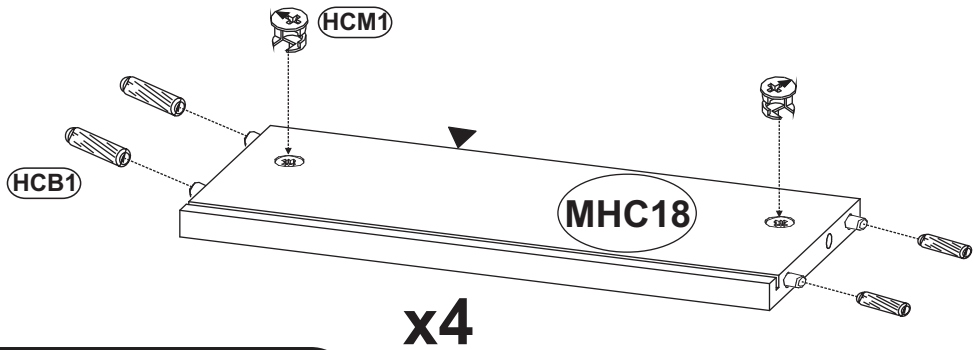

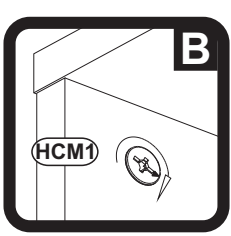
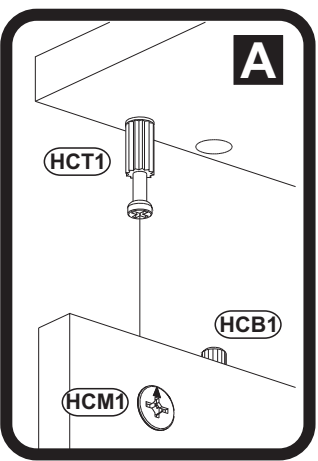
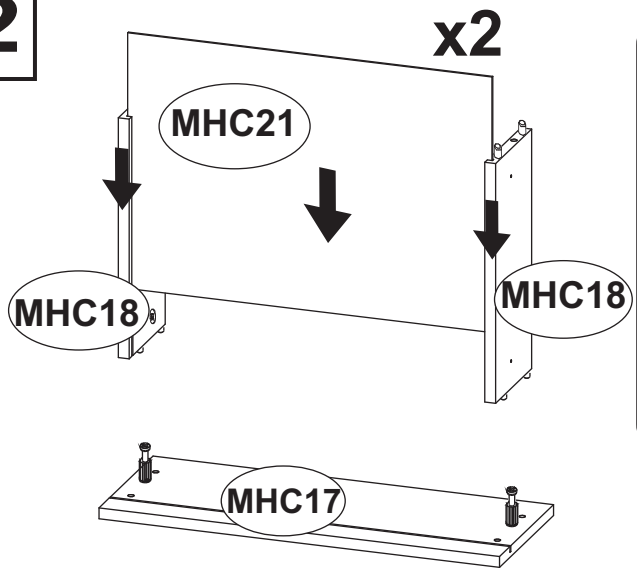

2

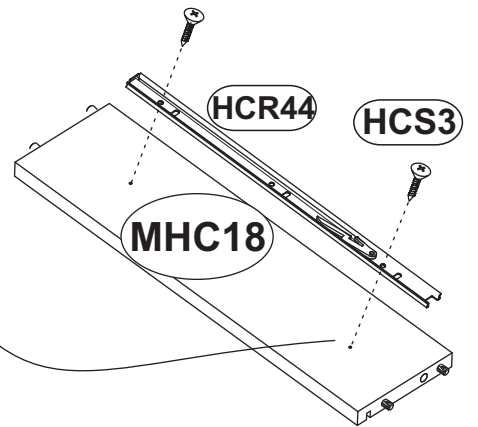
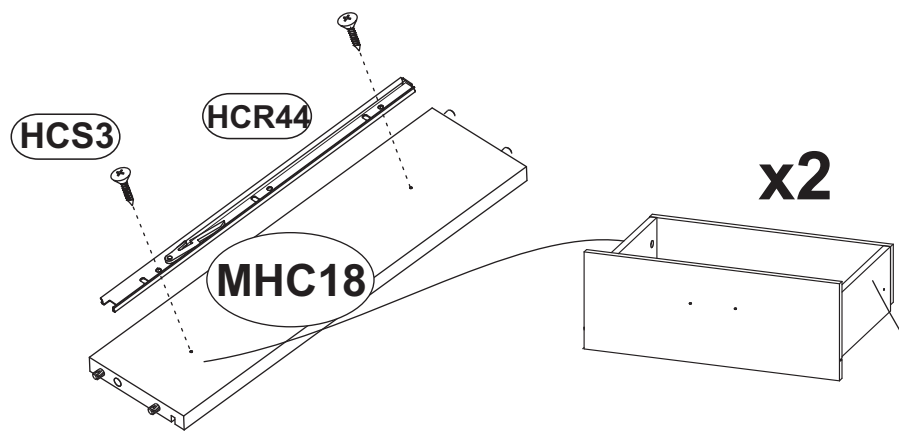
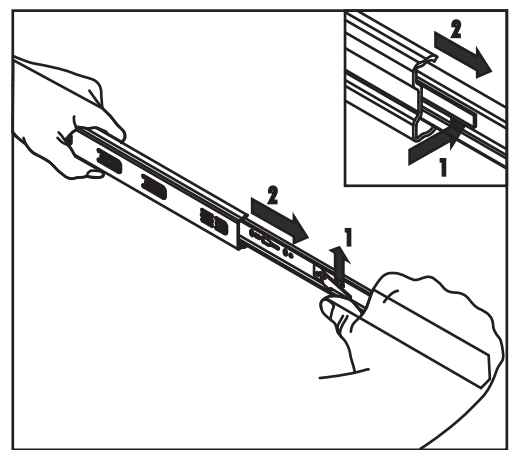
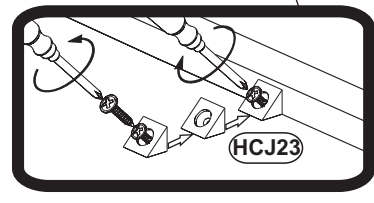
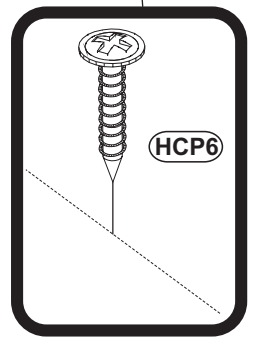
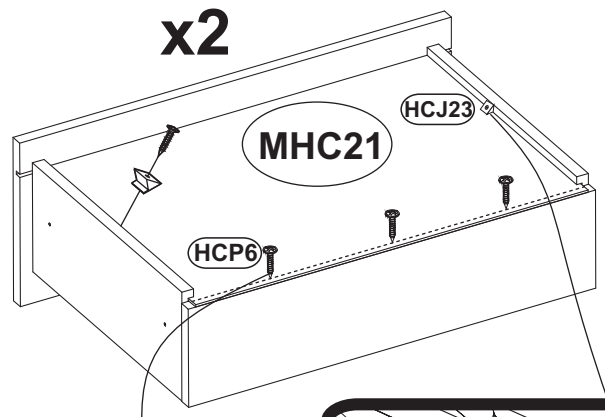
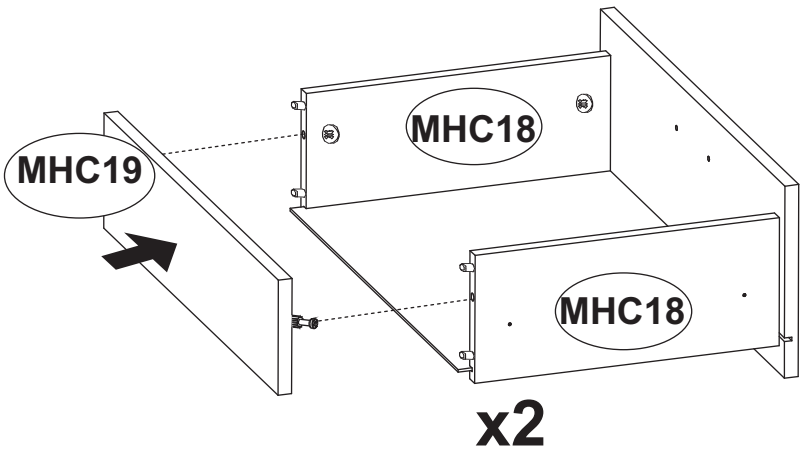

HCJ23	1302	x4
HCP6	1056	x6
HCS3	1011	x8
HCR44	123165	x4



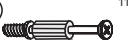

3

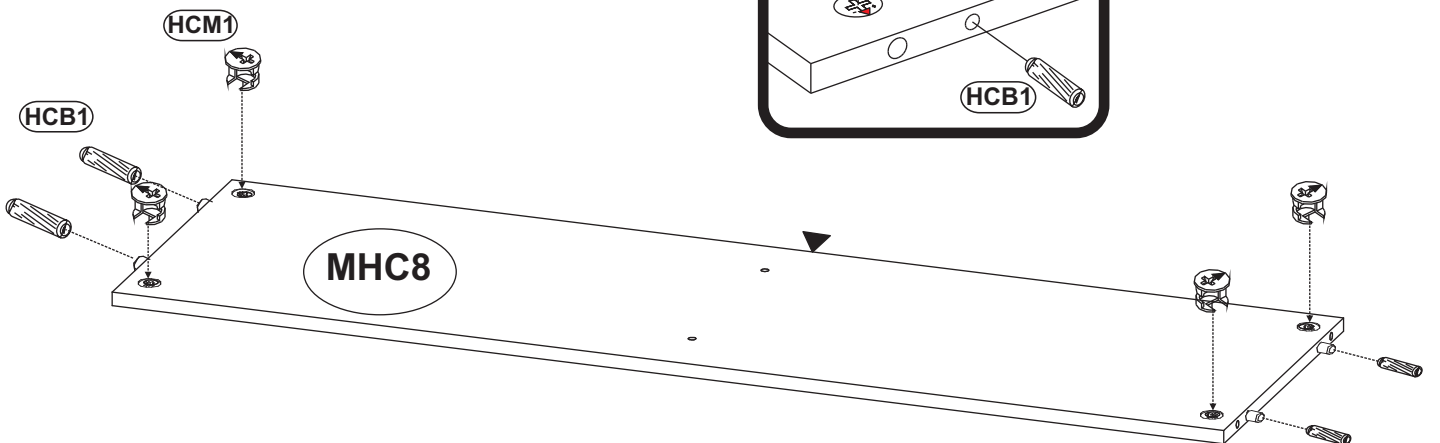
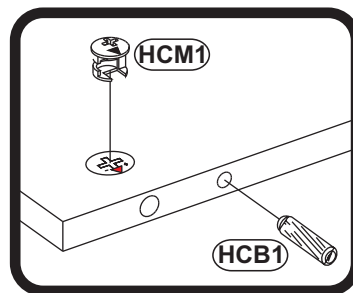
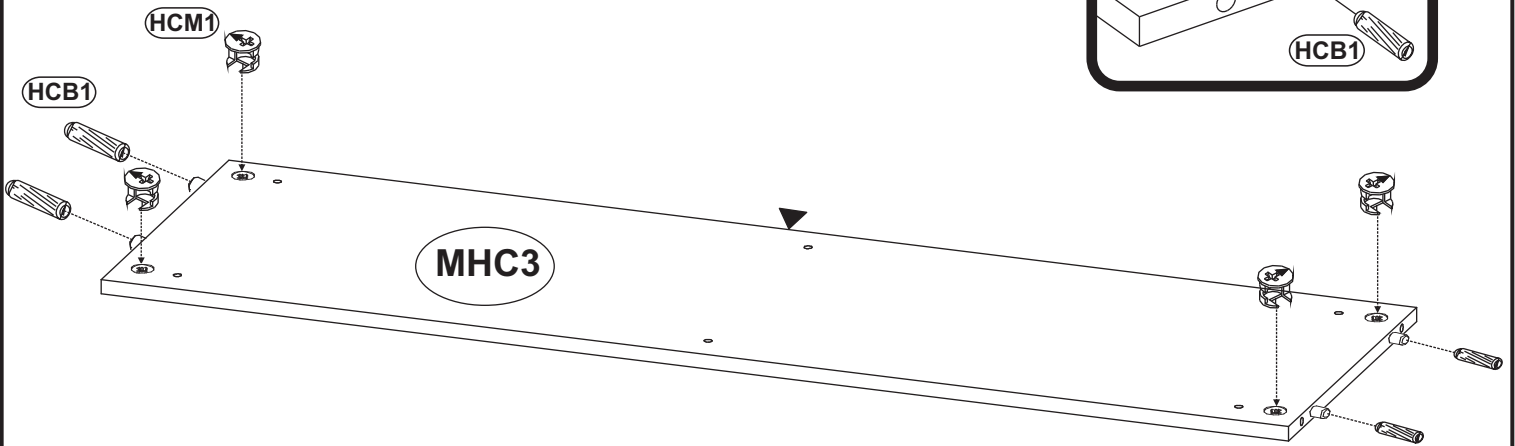
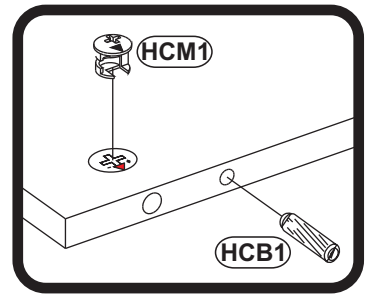
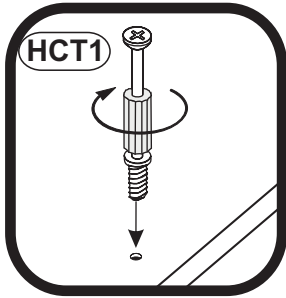
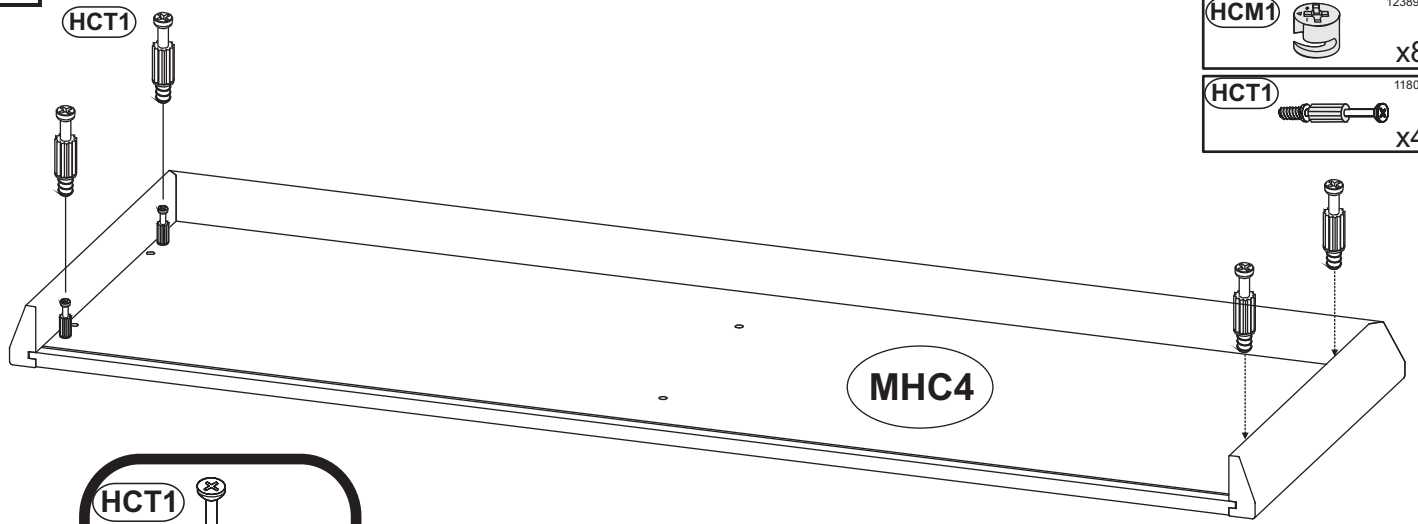
HCB1		1018
	8x28	x8
HCM1		123894
		x8
HCT1		11809
		x4

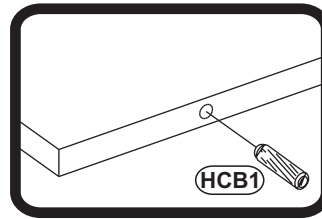
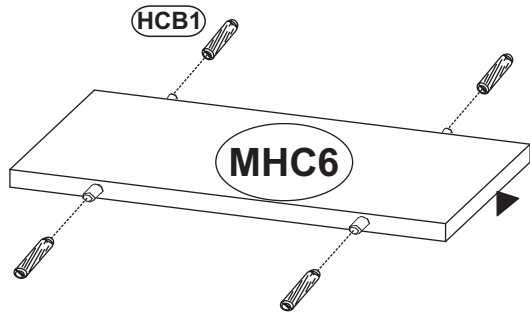





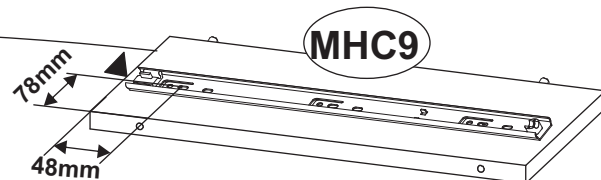
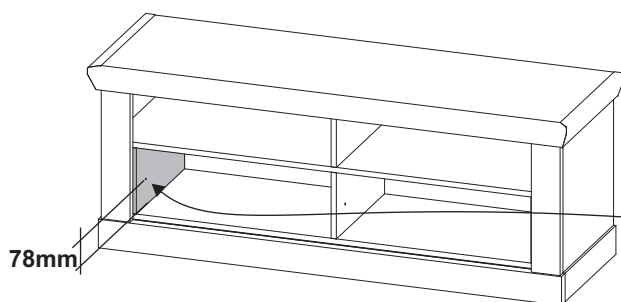
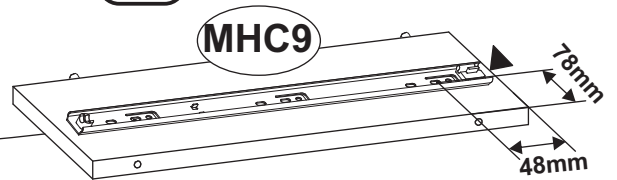
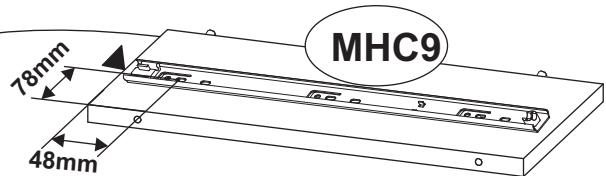
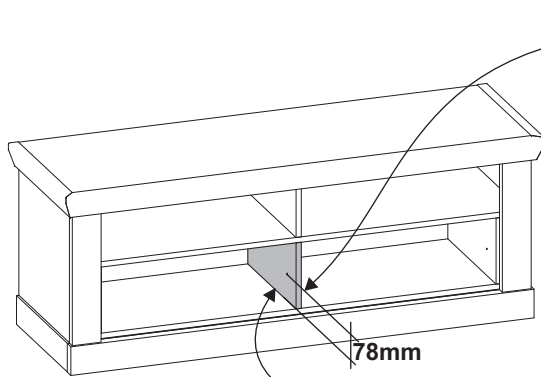
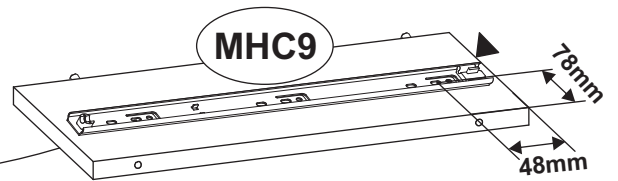
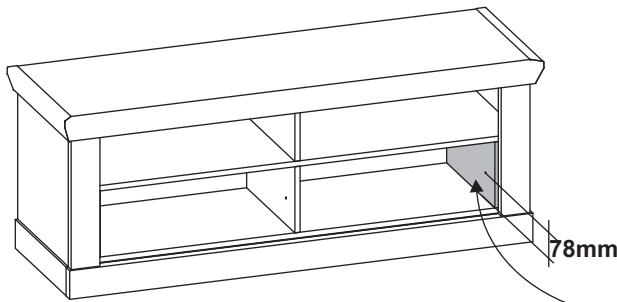
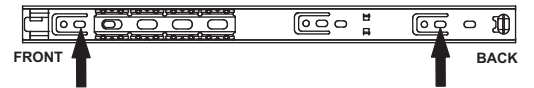
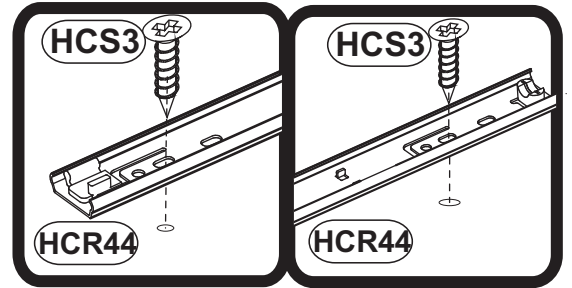
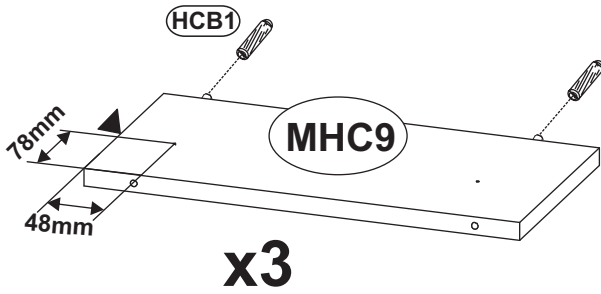

- HCB1**  1018
 8x28 x10
- HCR44**  123165
 L-350 x4
- HCS3**  1011
 3,5x13 x16



5

HCB1		1018
	8x28	x4
HCM1		123894
		x4
HCT1		11809
		x8
HCK13		49716
		x4
HCS3		1011
	3,5x13	x8

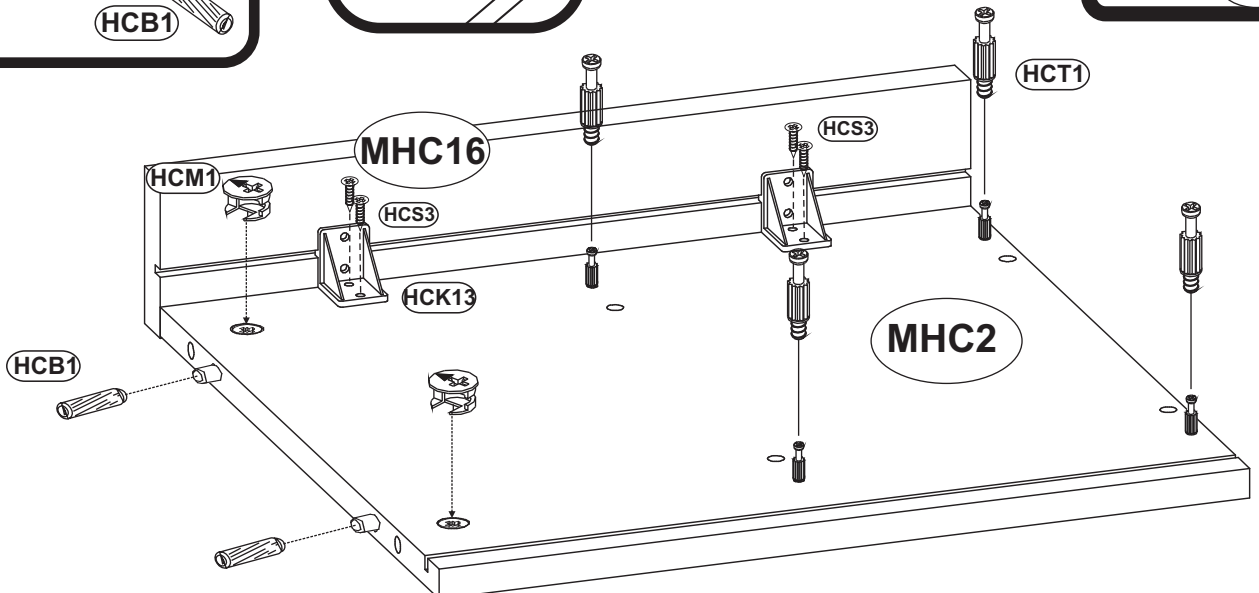
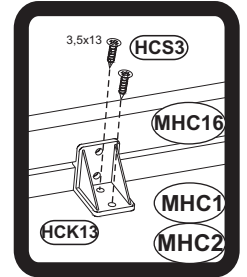
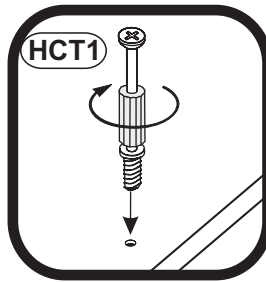
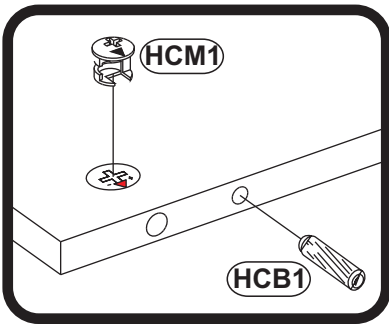
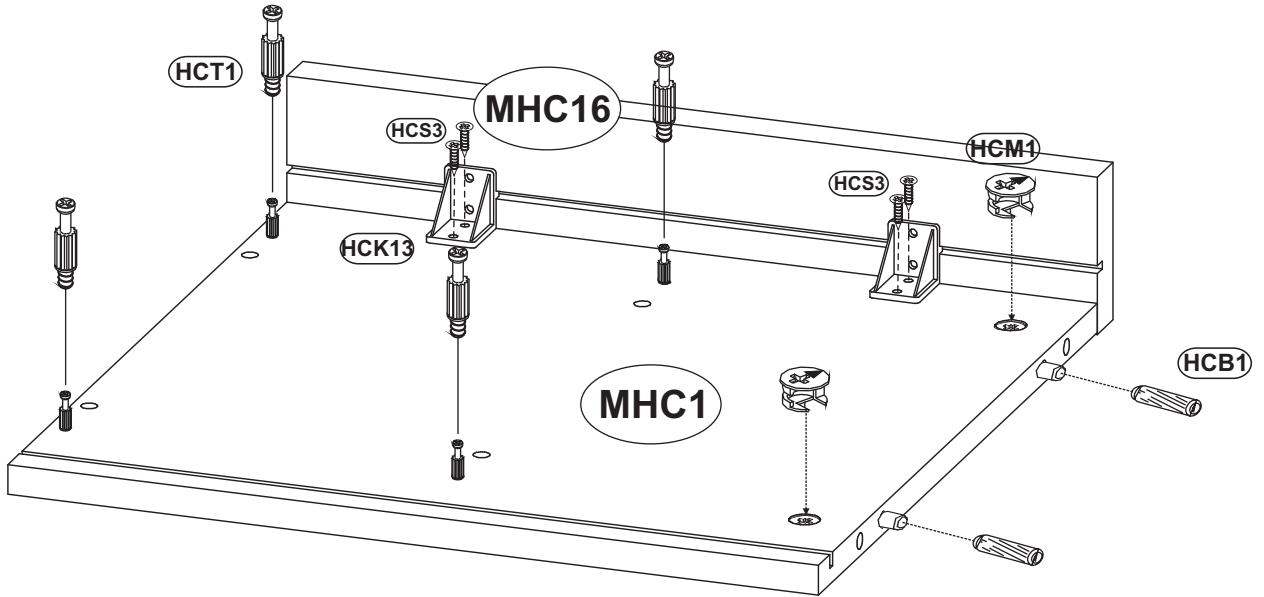
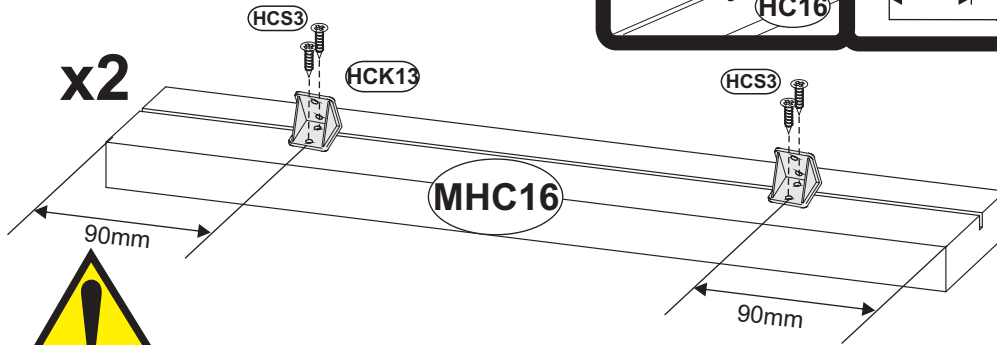
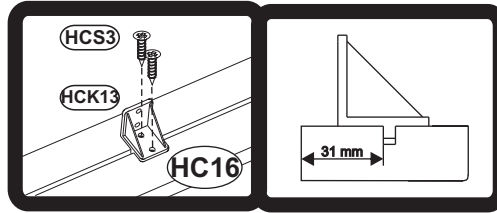

6

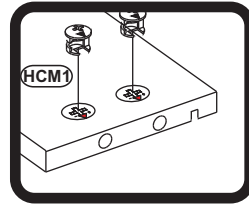
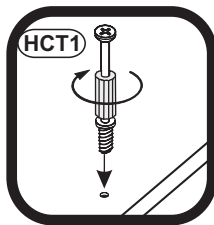
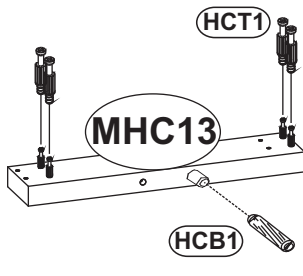
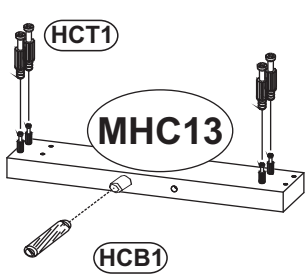

HCM1		123894	x8
HCT1		11809	x8
HCS3		1011	3,5x13 x12
HCK13		49716	x6
HCB1		1018	8x28 x2



x2

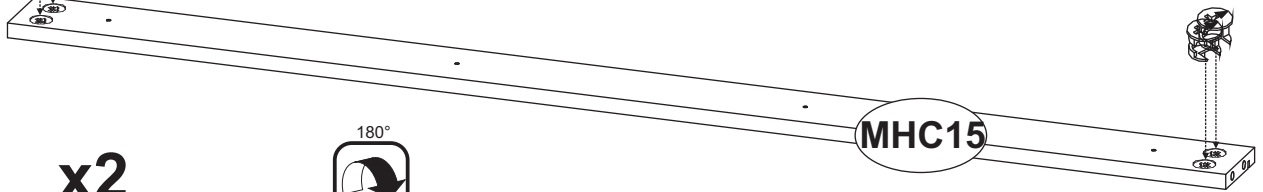

x2

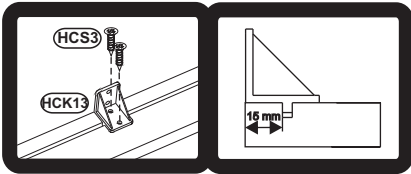
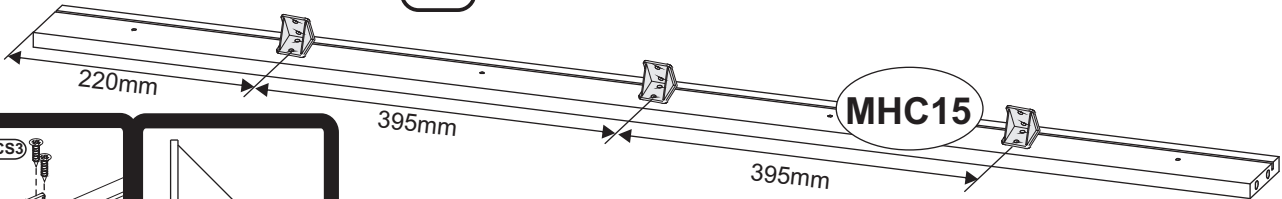

7

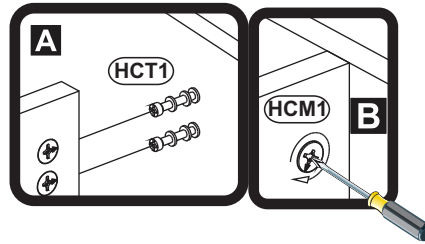

HCP13		1012	4x30 x4
HCF36		1305	x8

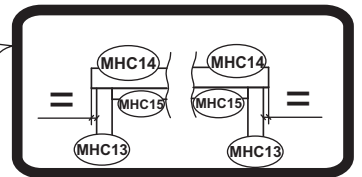
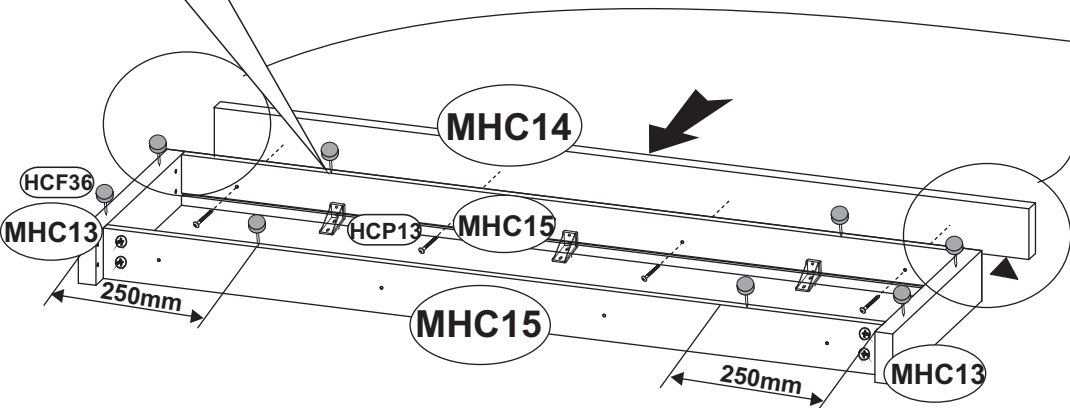
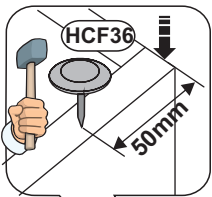
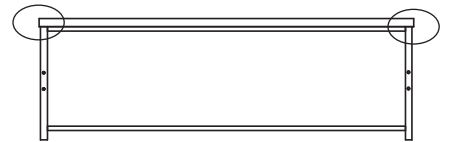
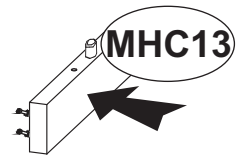
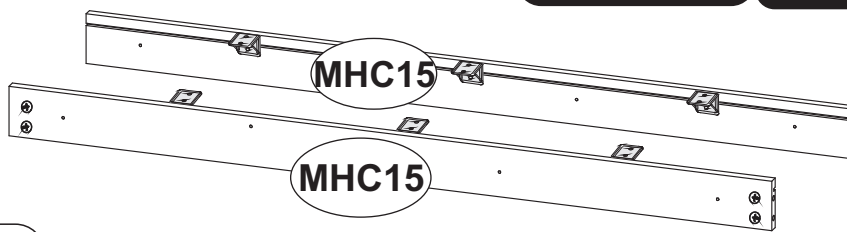

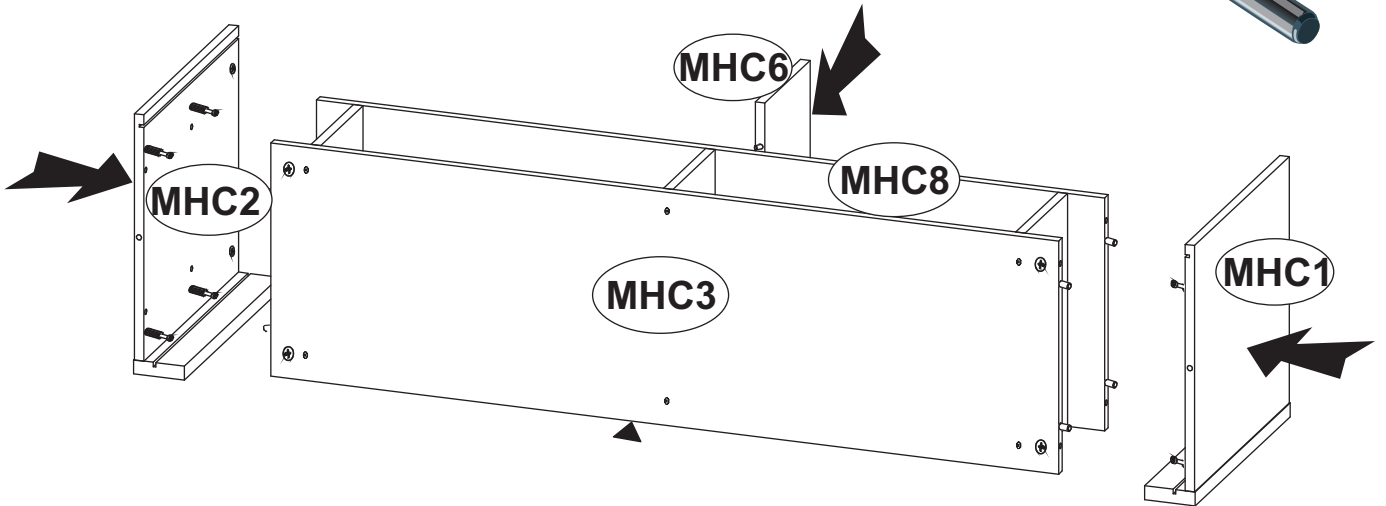
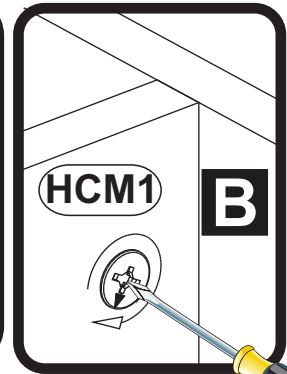
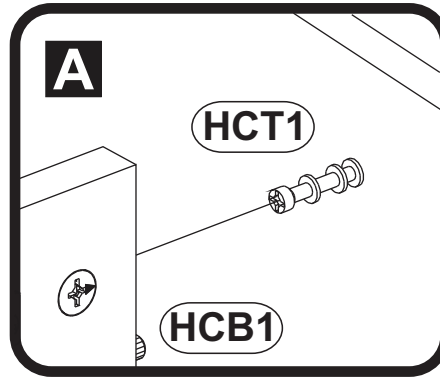
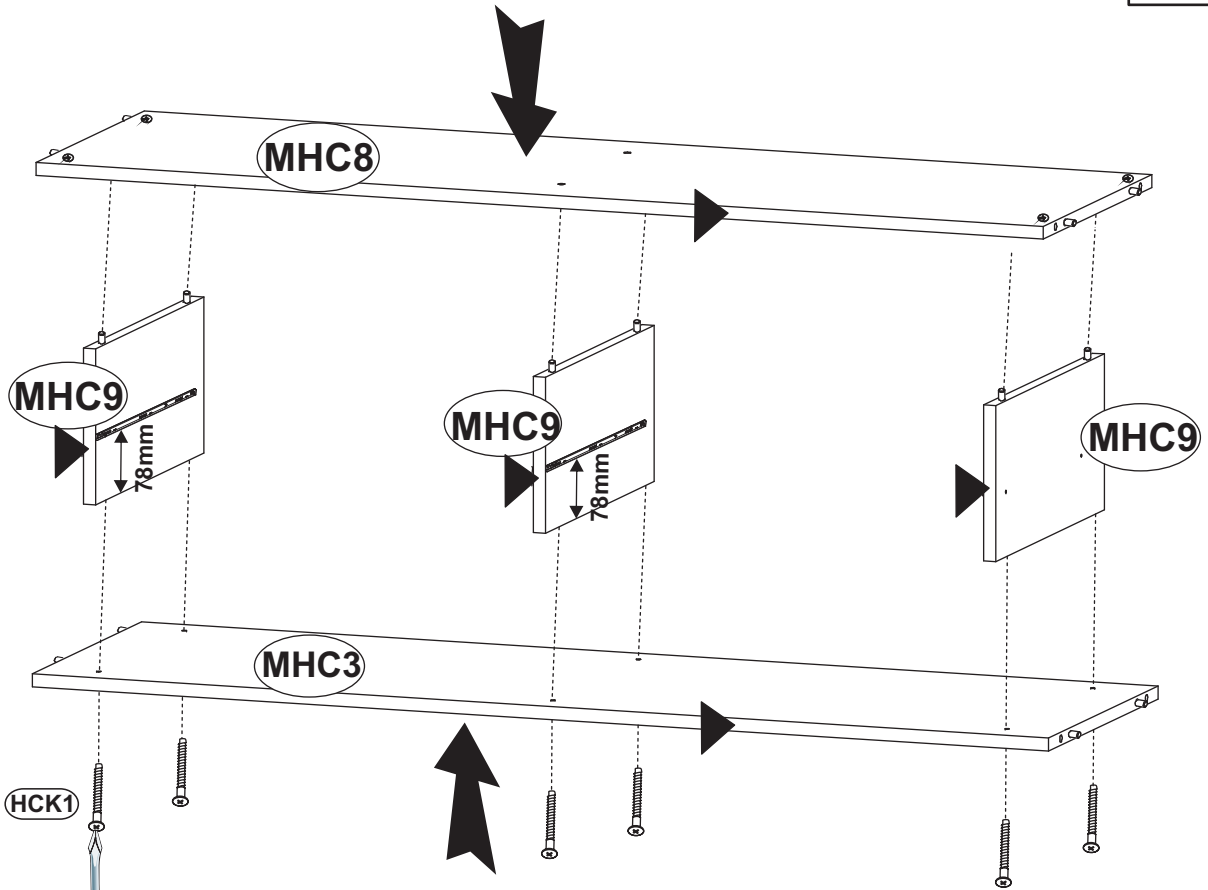

9

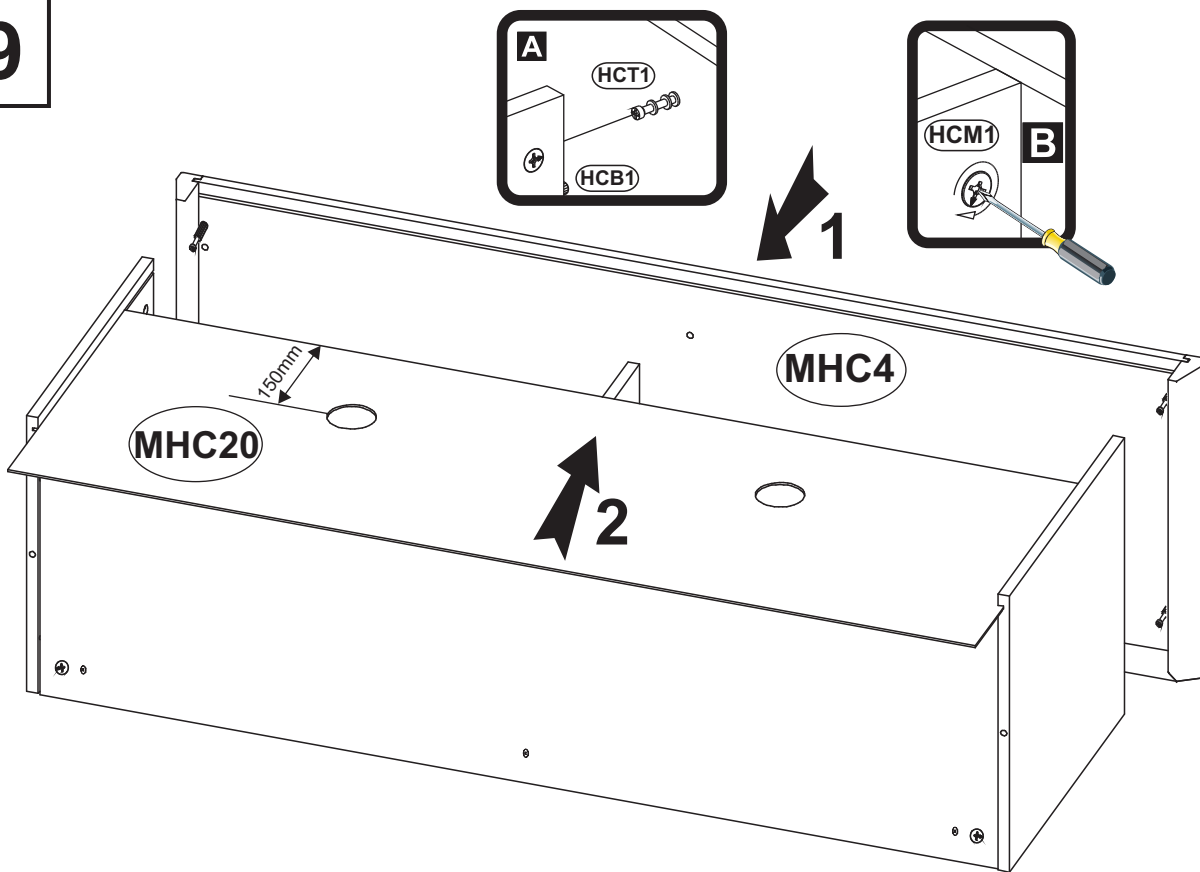

10

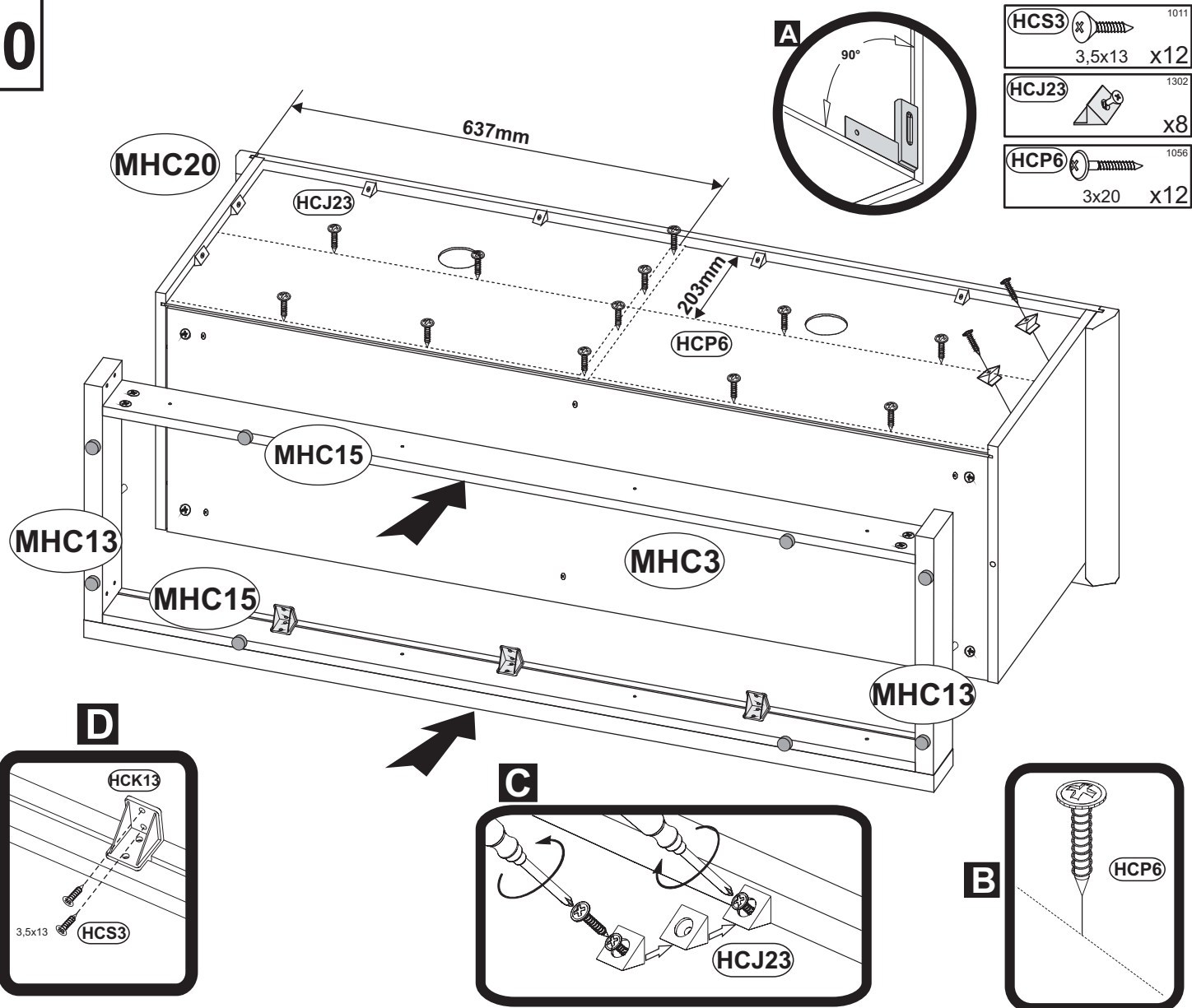

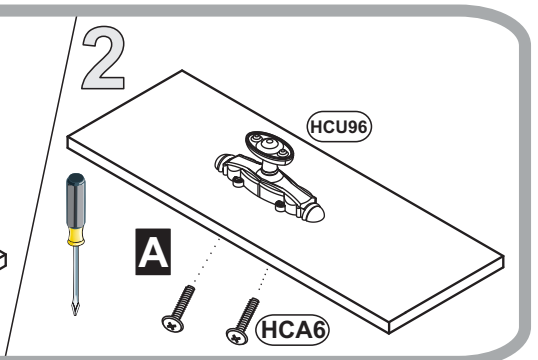
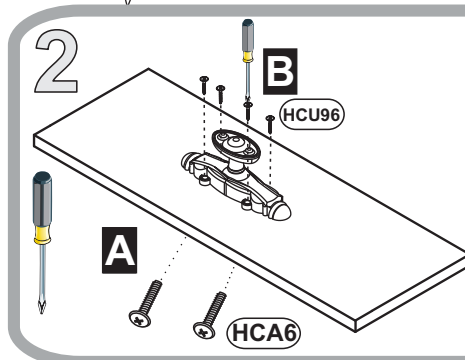
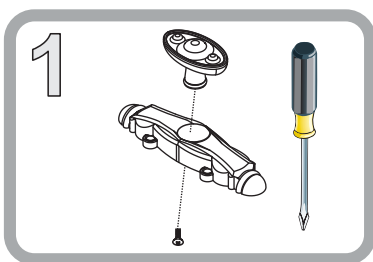
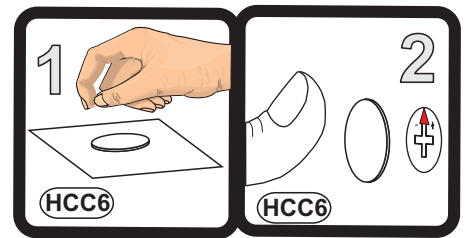
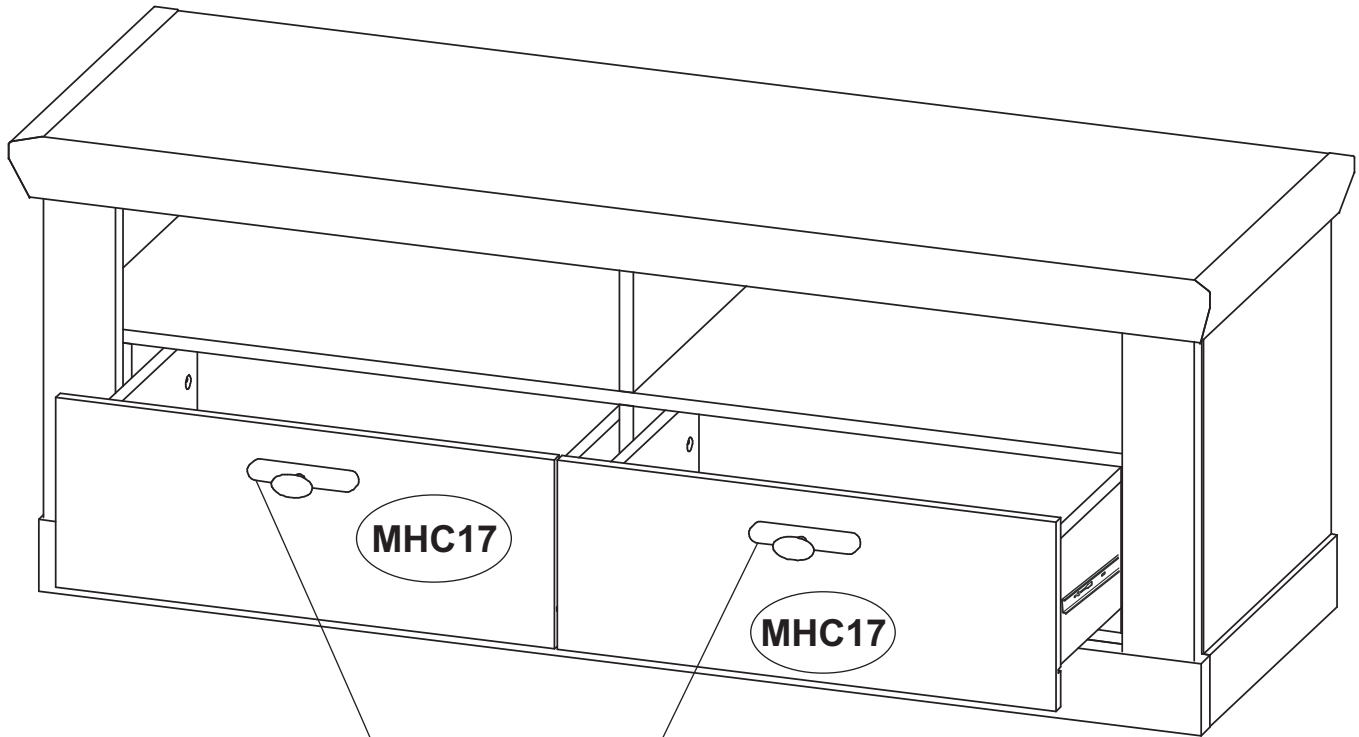
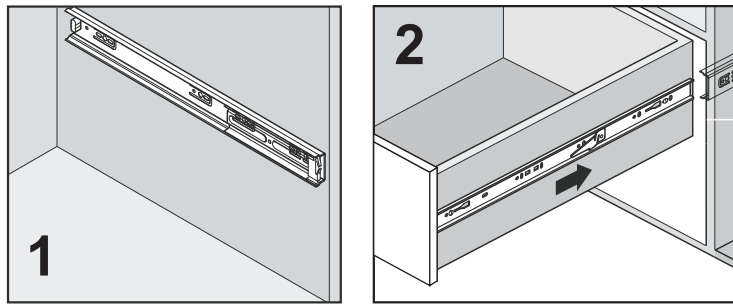
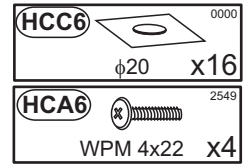
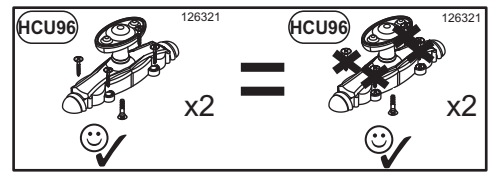

FLORENZ 31M

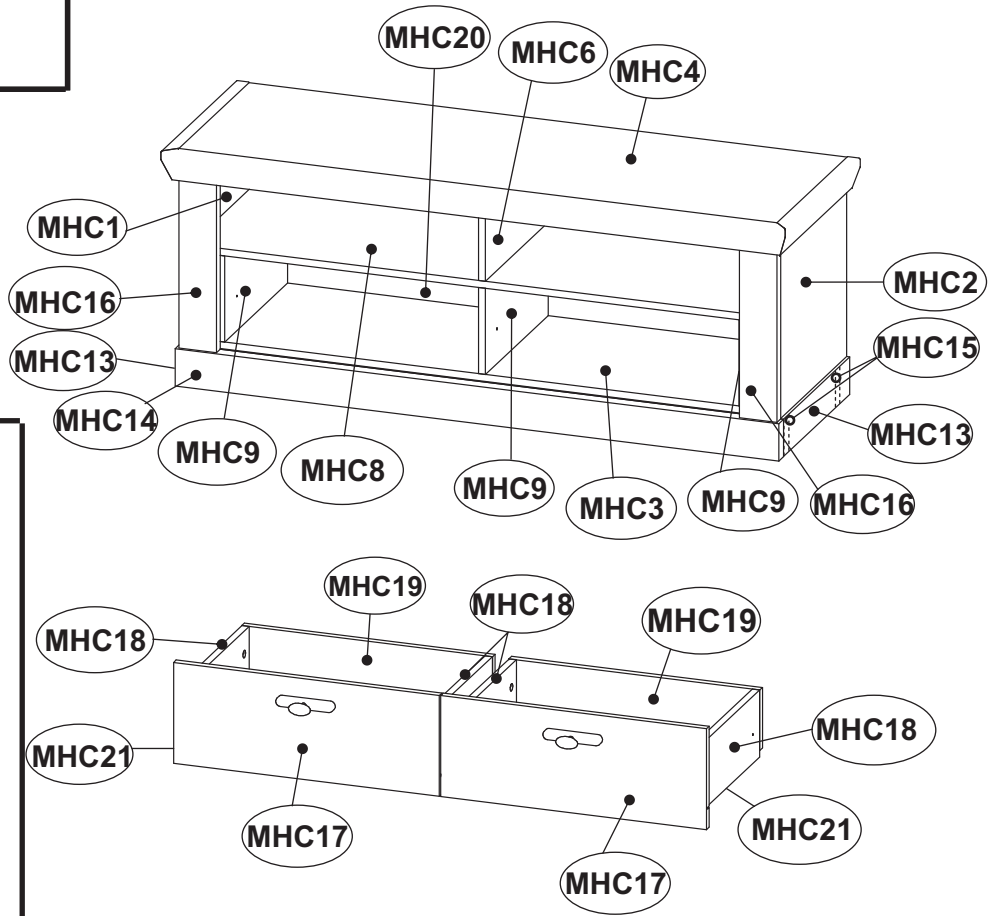

Unser Direktservice für Beschlagteile

Sollte Ihnen ein Beschlagteil fehlen, können Sie diese Servicekarte direkt an die untenstehende Adresse mailen. Wir können allerdings nur Beschlagteile auf diesem Wege verschicken. Sollten Sie eine andere Beanstandung an Ihrem Möbelstück haben, so wenden Sie sich bitte direkt an Ihr Möbelhaus.

Our direct order service for fitting

If a fitting part is missing, you can e-mail this service card directly to the address below. However, we can only send fitting parts in this way. If you have any other cause for complaint concerning your item of furniture, please contact your furniture store directly.

Naše primé služby pro kování

Chybí-li vám nějaký díl z kování, můžete tuto servisní kartu odeslat e-mailem přímo na níže uvedenou adresu. Touto cestou však můžeme rozesílat jen díly kování. Pokud byste reklamovali jiný díl nábytku, obraťte se přímo na svého prodejce nábytku.

Bien étudier la notice de montage

S'il vous manque une ferrure, veuillez envoyer directement la présente carte service à l'adresse e-mail indiquée ci-dessous. Cependant, ceci nous permet uniquement d'envoyer des ferrures. Pour tout autre type de réclamation concernant votre meuble, veuillez contacter directement votre magasin d'ameublement.

Il nostro servizio diretto per l'ordine della ferramenta

Qualora Vi dovesse mancare un pezzo di fissaggio, allora Vi preghiamo di inviare questa carta di servizio immediatamente all'indirizzo sottostante. Possiamo inviare i pezzi di fissaggio solamente per mezzo di questo procedimento. Qualora dovesse avere qualche altra reclamazione in merito al mobile, allora Vi preghiamo di rivolgerVi direttamente al Vostro Negozio di mobili.

Нашата директна услуга за обков

Ако липсват части от комплекта, попълнете настоящата сервисна карта и ни я изпратете на e-mail адреса, посочен по-долу. По този начин можем да доставяме само липсващи елементи от обкова. Ако установите други дефекти по мебелите, Ви съветваме да се обърнете към мебелната къща/магазин, от който сте закупили стоката.

Onze directservice voor losse onderdelen

Wanneer er een onderdeel ontbreekt, kunt u deze servicekaart direct aan onderstaand e-mailadres sturen. Wij kunnen langs deze weg echter alleen beslagdelen versturen. Mocht u een ander probleem aan uw meubel hebben, verzoeken wij u contact op te nemen met uw meubeldealer.

Nasz bezpośredni serwis części montażowych

Jeżeli brakuje części koniecznych do montażu, prosimy o przesłanie nam niniejszej karty serwisowej na niżej podany adres e-mailowy. W ten sposób możemy przysłać Państwu tylko brakujące części. W przypadku innych reklamacji dotyczących mebla, prosimy zgłosić się do salonu meblowego, w którym został dokonany zakup.

Servis za okove

U slučaju da nedostaje neki od dijelova molimo vas da na dolje navedenu mail adresu pošaljete ovaj servisni obrazac. Na ovaj način mogu se dostaviti samo okovi. U slučaju da imate dodatne prigovore vezane uz komad namještaja molimo vas da se obratite izravno trgovini namještaja gdje je isti kupljen.

Direktszolgáltatunk vasalatók esetén

Ha hiányzik egy vasalat, ezt a kártyát közvetlenül elküldheti az alábbi taláható címre. Azonban csak vasalatókat tudunk így küldeni. Amennyiben másfajta reklamációt áll fenn bütördarabját illetően, forduljon közvetlenül a bütörházhoz.

Naše priamý servis pre časti kovania

Ak by Vám chýbala nejaká časť kovania, môžete poslať túto servisnú kartu pošlou e-mailom na nižšie uvedenú adresu. Diely kovania vieme poslať iba týmto spôsobom. Ak by ste mali inú reklamáciu ohtodom Vášho nábytku, obráťte sa priamo na Vašu predajňu nábytku.

Naše direktne uslužne storitve za okovje

Če vam manjka kakšno okovje, lahko to servisno kartico pošljete po e-pošti direktno na spodnji naslov. Po tej poti vam lahko pošljemo samo okovje. Če želite reklamirati kakšen drug del pohištva, se obrnite neposredno na vašo trgovino pohištva.

Serviciul nostru direct pentru feronerie

În cazul în care vă lipsește o piesă de feronerie puteți să trimiteți direct acest card de service prin e-mail la adresa de mai jos. Noi nu putem expedia piese de feronerie decât pe această cale. Dacă aveți o altă reclamație referitoare la piesa de mobilier, atunci vă rugăm să vă adresați direct la magazinul dvs. de mobilă.

Наш прямой сервис для поставок фурнитуры

Если окажется, что Вам не хватает того или иного элемента фурнитуры, Вы можете отправить сервисную карту по факсу непосредственно на нижеприведенный адрес электронной почты. Однако, таким образом мы можем переслать лишь фурнитуру. Если же у Вас возникнут иные претензии относительно приобретенной мебели, пожалуйста, обращайтесь непосредственно в организацию, осуществившую продажу.

Vår direktservice för beslagdelar

Om du saknar en beslagdel kan du skicka detta servicekort direkt till e-postadressen som anges nedan. Tank på att detta är den enda möjligheten att skicka beslagdelar till dig. Om du vill reklamera din möbel av en annan anledning måste du kontakta ditt möbelför direkt.

Nuestro servicio directo para accesorios

Si le falta algún accesorio, puede enviar esta tarjeta de servicio directamente a la siguiente dirección. No obstante, por este método solo podemos enviar accesorios. Si tiene alguna otra objeción sobre su mueble, consulte directamente con su mueblería.

Donatilar için doğrudan servisimiz

Bir donatınız eksikse bu servis kartını doğrudan aşağıda bulunan adrese doğrudan mail yazabilirsiniz. Sadece bu yolla donatıları gönderebiliriz. Mobilyanızda başka şikayetleriniz varsa lütfen doğrudan mobilya satıcınıza danışın.

MHC1	411	389	15	1/1
MHC2	411	389	15	1/1
MHC3	1244	368	15	1/1
MHC4	1332	439,5	65	1/1
MHC6	196	367	15	1/1
MHC8	1244	368	15	1/1
MHC9	185	368	15	1/1
MHC13	386	80	28	1/1
MHC14	1288	80	28	1/1
MHC15	1231	80	15	1/1

MHC16	411	80	22	1/1
MHC17	553	210	15	1/1
MHC18	332	140	15	1/1
MHC19	522	126	15	1/1
MHC20	1256	416	3	1/1
MHC21	503	354	3	1/1

FLORENZ 31M

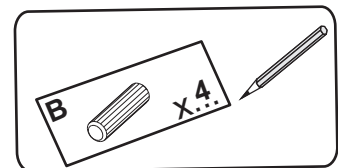
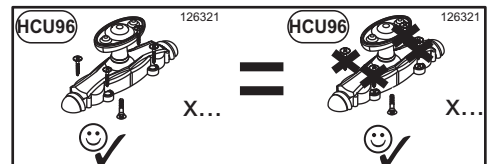
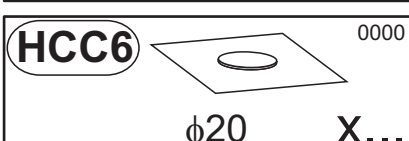
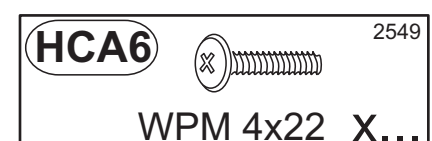
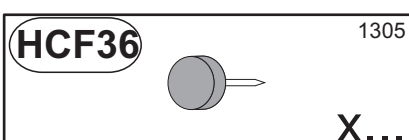
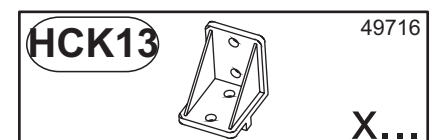
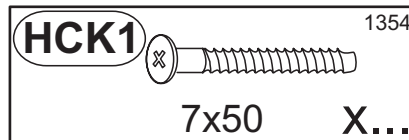
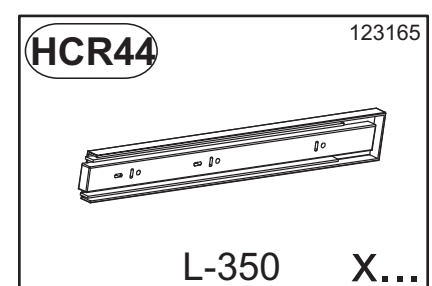
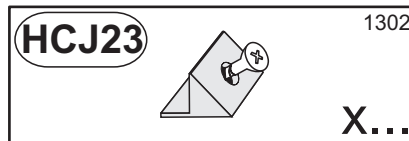
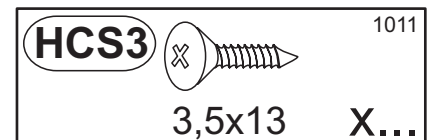
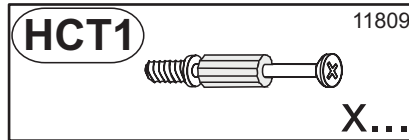
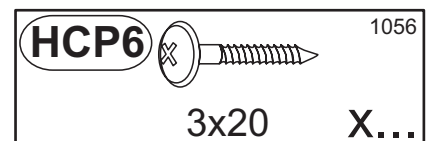
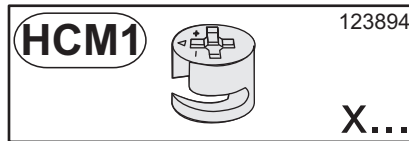
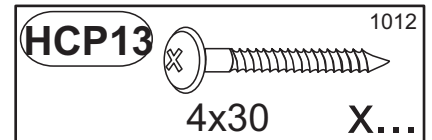
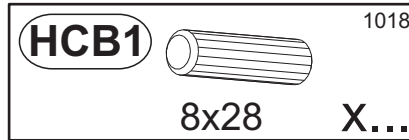

D Unser Direktservice für Beschlagteile
Sollte Ihnen ein Beschlagteil fehlen, können Sie diese Servicekarte direkt an die untenstehende Adresse mailen. Wir können allerdings nur Beschlagteile auf diesem Wege verschicken. Sollen Sie eine andere Beanstandung an Ihrem Möbelstück haben, so wenden sie sich bitte direkt an Ihr Möbelhaus.

GB Our direct order service for fitting
If a fitting part is missing, you can e-mail this service card directly to the address below. However, we can only send fitting parts in this way. If you have any other cause for complaint concerning your item of furniture, please contact your furniture store directly.

CZ Naše přímé služby pro kování
Chybí-li vám nějaký díl z kování, můžete tuto servisní kartu odeslat e-mailem přímo na níže uvedenou adresu. Touto cestou však můžeme rozesílat jen díly kování. Pokud byste reklamovali jiný díl nábytku, obraťte se přímo na svého prodejce nábytku.

F Bien étudier la notice de montage
S'il vous manque une ferrure, veuillez envoyer directement la présente carte service à l'adresse e-mail indiquée ci-dessous. Cependant, ceci nous permet uniquement d'envoyer des ferrures. Pour tout autre type de réclamation concernant votre meuble, veuillez contacter directement votre magasin d'ameublement.

I Il nostro servizio diretto per l'ordine della ferramenta
Qualora Vi dovesse mancare un pezzo di fissaggio, allora Vi preghiamo di inviare questa carta di servizio immediatamente all'indirizzo sottostante. Possiamo inviare i pezzi di fissaggio solamente per mezzo di questo procedimento. Qualora dovesse avere qualche altra reclamazione in merito al mobile, allora Vi preghiamo di rivolgerVi direttamente al Vostro Negozio di mobili.

BG Нашата директна услуга за обкоя
Ако липсват части от комплекта, попълнете настоящата сервисна карта и ни я изпратете на e-mail адреса, посочен по-долу. По този начин можем да доставяме само липсващи елементи от обкоя. Ако установите други дефекти по мебелите, Ви съветваме да се обрънете към мебелната къща/магазин, от който сте закупили стоката.

NL Onze directservice voor losse onderdelen
Wanneer er een onderdeel ontbreekt, kunt u deze servicekaart direct aan onderstaand e-mailadres sturen. Wij kunnen langzame weg echter alleen beslagdelen versturen. Mocht u een ander probleem aan uw meubel hebben, verzoeken wij u contact op te nemen met uw meubeldealer.

PL Nasz bezpośredni serwis czeski montażowy
Jeżeli brakuje części koniecznych do montażu, prosimy o przesłanie nam niniejszej karty serwisowej na niżej podany adres e-mailowy. W ten sposób możemy przesać Państwu tylko brakujące części. W przypadku innych reklamacji dotyczących mebla, prosimy zgłosić się do salonu meblowego, w którym został dokonany zakup.

HR Servis za okove
U slučaju da nedostaje neki od dijelova molimo vas da na dolje navedenu mail adresu pošaljete ovaj servisni obrazac. Na ovaj način mogu se dostaviti samo okovi. U slučaju da imate dodatne prigovore vezane uz komad namještaja molimo vas da se obratite izravno trgovini namještaja gdje je isti kupljen.

HU Direktszolgáltatunk vasalatok esetén
Ha hiányzik egy vasalát, ezt a kártyát közvetlenül elküldheti az alább található címre. Azonban csak vasalátokat tudunk így küldeni. Amennyiben másfajta reklamáció áll fenn bútordarabát illetően, forduljon közvetlenül a bútorházhoz.

SK Naš priamy servis pre časti kovania
Ak by Vám chýbala nejaká časť kovania, môžete poslať túto servisnú kartu poslať e-mailom na nižšie uvedenú adresu. Díly kovania vieme poslať iba týmto spôsobom. Ak by ste mali inú reklamáciu ohľadom Vášho nábytku, obráťte sa priamo na Vašu predajňu nábytku.

SLO Naše direktne uslužne storitve za okovje
Ce vam manjka kakšno okovje, lahko to servisno kartico pošljete po e-pošti direktno na spodnji naslov. Po tej poti vam lahko pošljemo samo okovje. Če želite reklamirati kakšen drug del pohištva, se obrnite neposredno na vašo trgovino pohištva.

RO Service-ul nostru direct pentru feronerie
In cazul in care va lipseste o piesa de feronerie puteti sa trimiteți direct acest card de service prin e-mail la adresa de mai jos. Noi nu putem expedia piese de feronerie decât pe această cale. Dacă aveți o altă reclamație referitoare la piesa de mobilier, atunci vă rugăm să vă adresați direct la magazinul dvs. de mobila.

RUS Наш прямой сервис для поставок фурнитуры
Если окажется, что Вам не хватает того или иного элемента фурнитуры, Вы можете отправить сервисную карту по факсу непосредственно на нижеприведенный адрес электронной почты. Однако, таким образом мы можем пересылать лишь фурнитуру. Если же у Вас возникнут иные претензии относительно приобретенной мебели, пожалуйста, обращайтесь непосредственно в организацию, осуществившую продажу.

S Vir direktservice för beslagsdelar
Om du saknar en beslagsdel kan du skicka detta servicekort direkt till e-postadressen som anges nedan. Tänk på att detta är den enda möjligheten att skicka beslagsdelar till dig. Om du vill reklamera din möbel av en annan anledning måste du kontakta ditt möbelhus direkt.

ES Nuestro servicio directo para accesorios
Si le falta algún accesorio, puede enviar esta tarjeta de servicio directamente a la siguiente dirección. No obstante, por este método solo podemos enviar accesorios. Si tiene alguna otra objeción sobre su mueble, consulte directamente con su mueblería.

TR Donatılar için doğrudan servisimiz
Bir donatınız eksikse bu servis kartını doğrudan aşağıda bulunan adrese doğrudan mail yazabilirsiniz. Sadece bu yolla donatılar gönderiliriz. Mobilyanızda başka şikayetleriniz varsa lütfen doğrudan mobilya satıcınıza danışın.

FLORENZ 46M

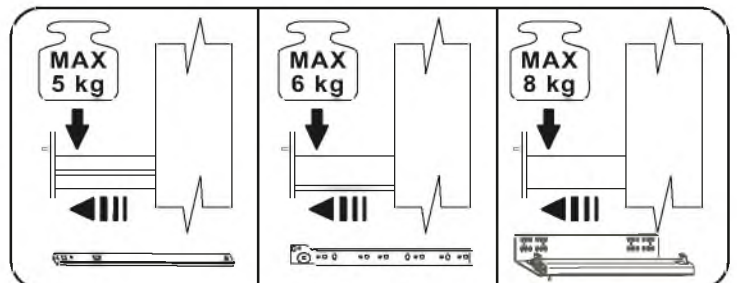
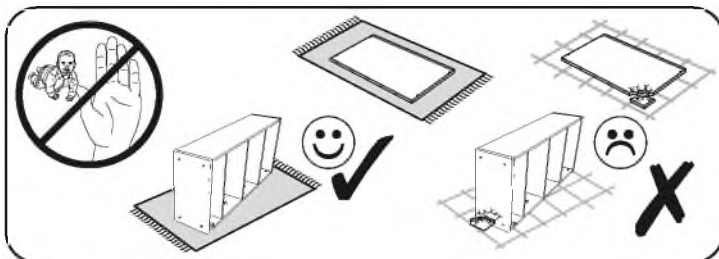
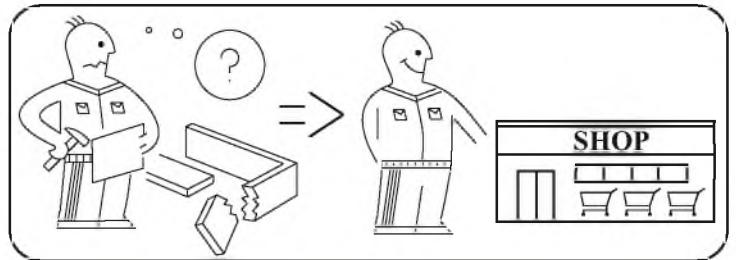
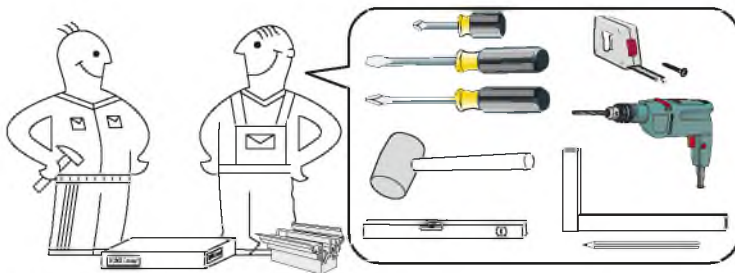
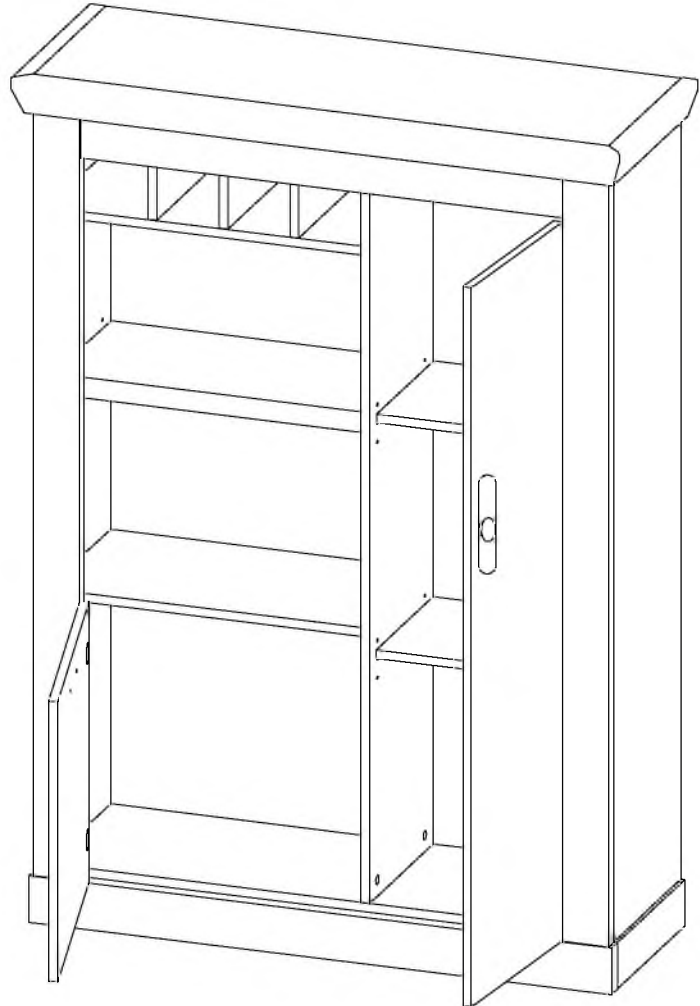
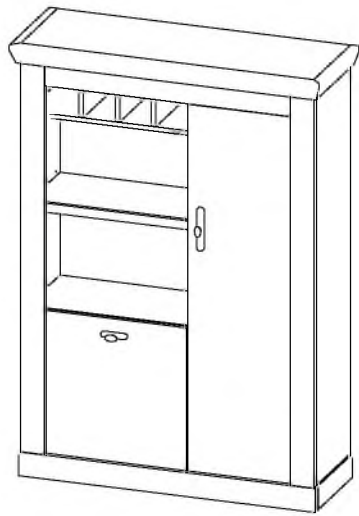

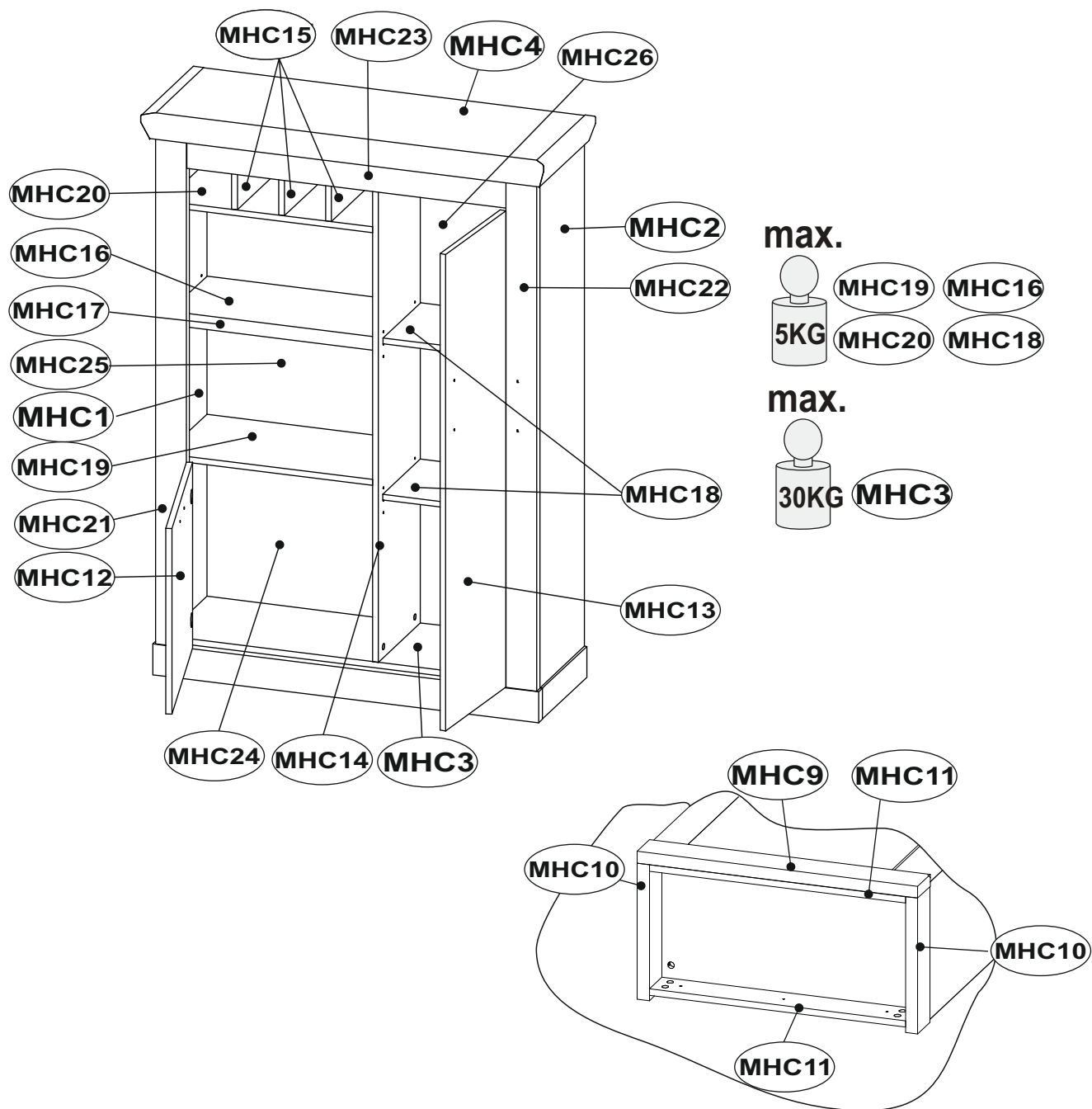

MHC1	1361	320	15	2/2
MHC2	1361	320	15	2/2
MHC3	956	299	15	1/2
MHC4	1044	370,5	65	1/2
MHC9	1000	80	28	1/2
MHC10	317	80	28	1/2
MHC11	943	80	15	1/2
MHC12	481	474	15	2/2
MHC13	1235	345	15	2/2
MHC14	1346	299	15	2/2
MHC15	219	297	15	1/2
MHC16	537	267	15	1/2

MHC17	535	30	16	1/2
MHC18	402	267	15	1/2
MHC19	538	299	15	1/2
MHC20	538	299	15	1/2
MHC21	1361	80	22	2/2
MHC22	1361	80	22	2/2
MHC23	828	120	18	1/2
MHC24	478	551	3	2/2
MHC25	888	551	3	2/2
MHC26	1366	417	3	2/2

FLORENZ 46M

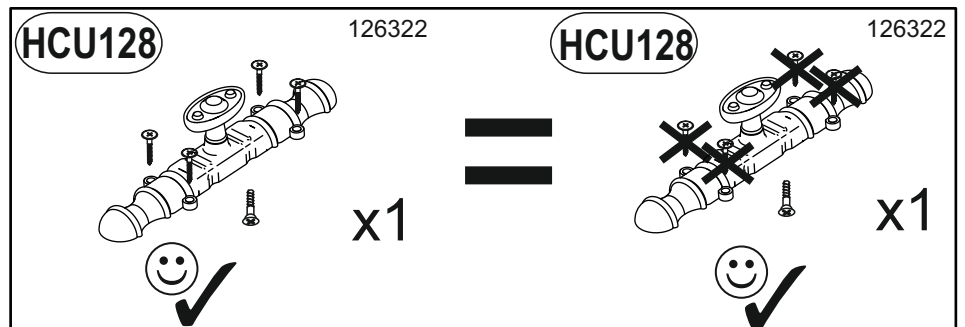
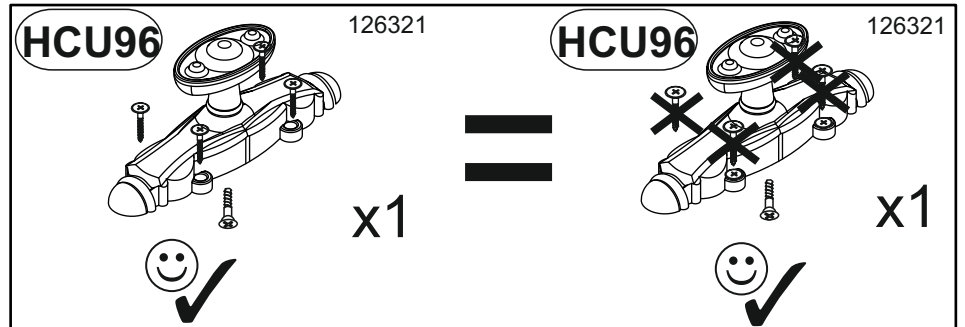
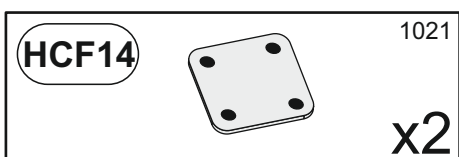
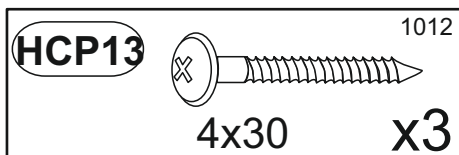
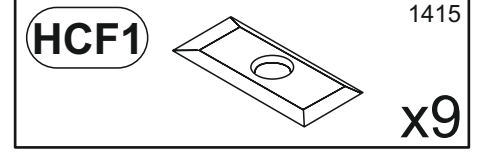
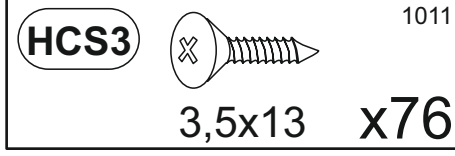
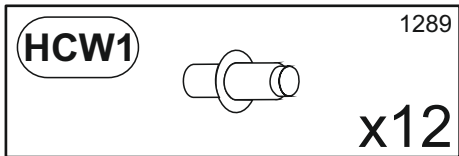
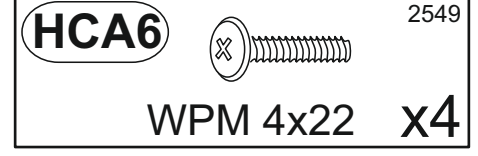
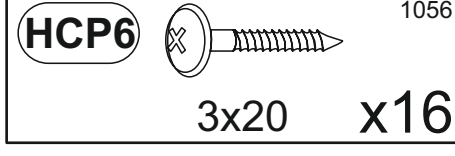
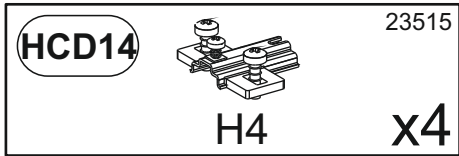
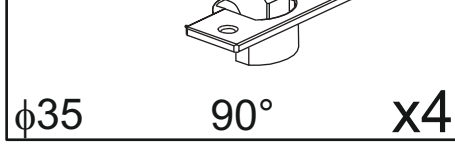
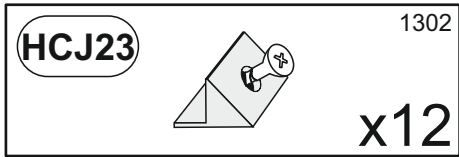
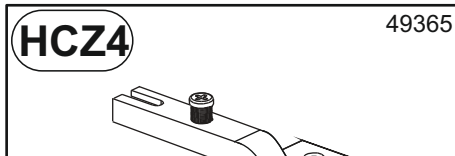
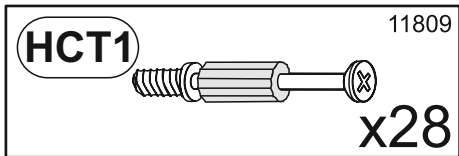
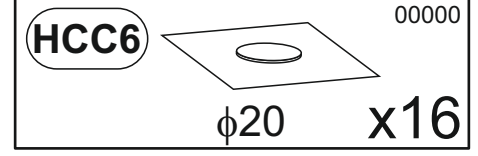
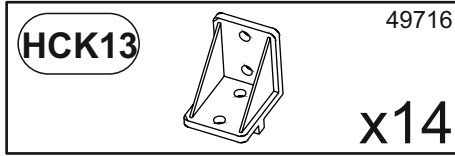
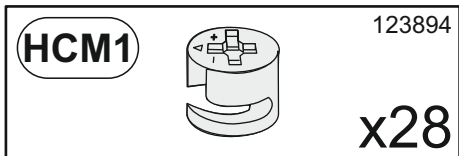
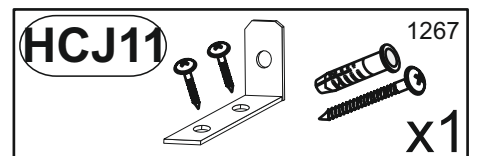
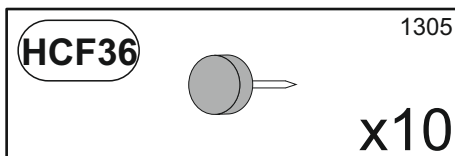
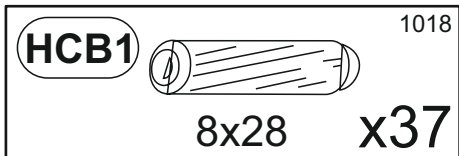

1

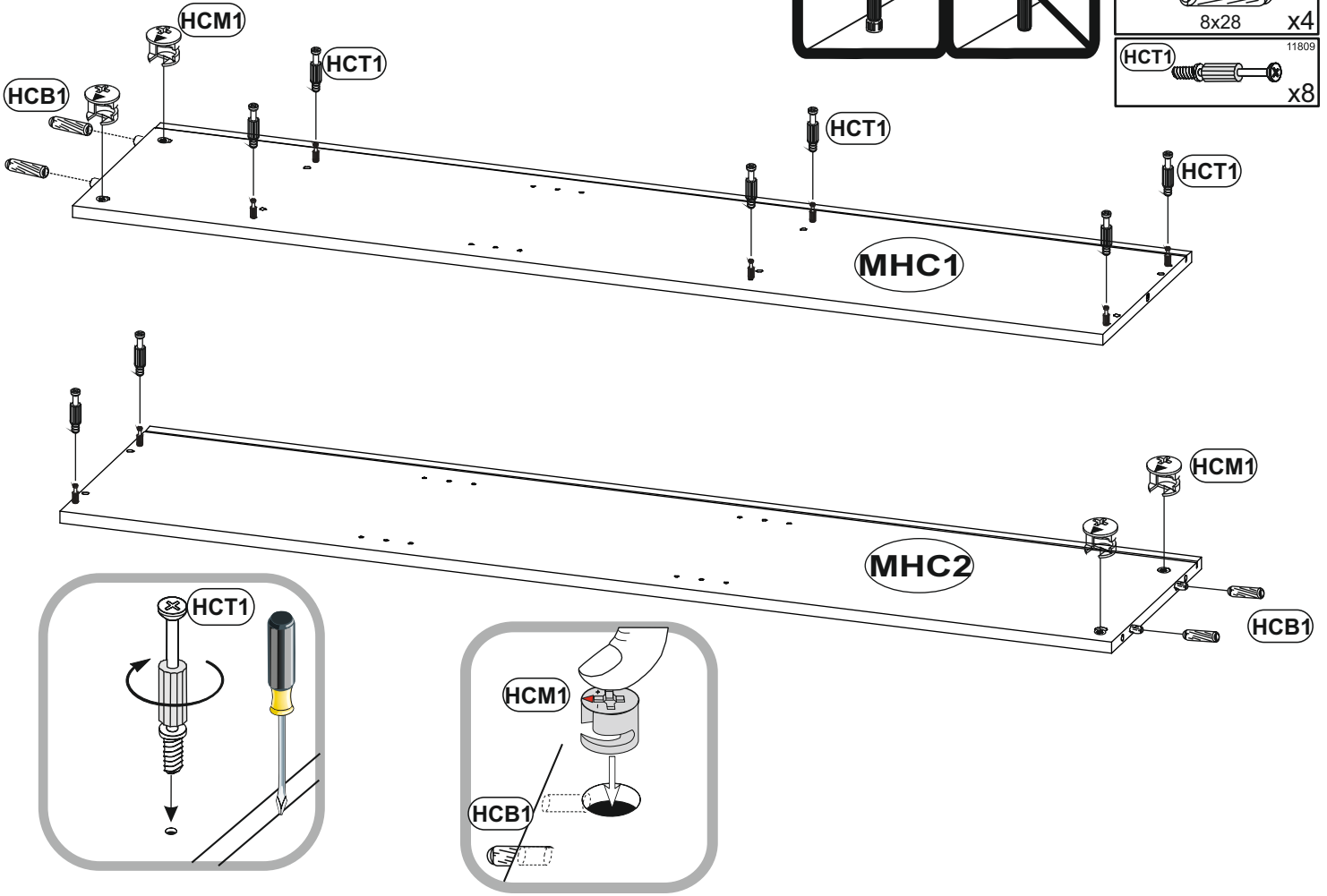

2

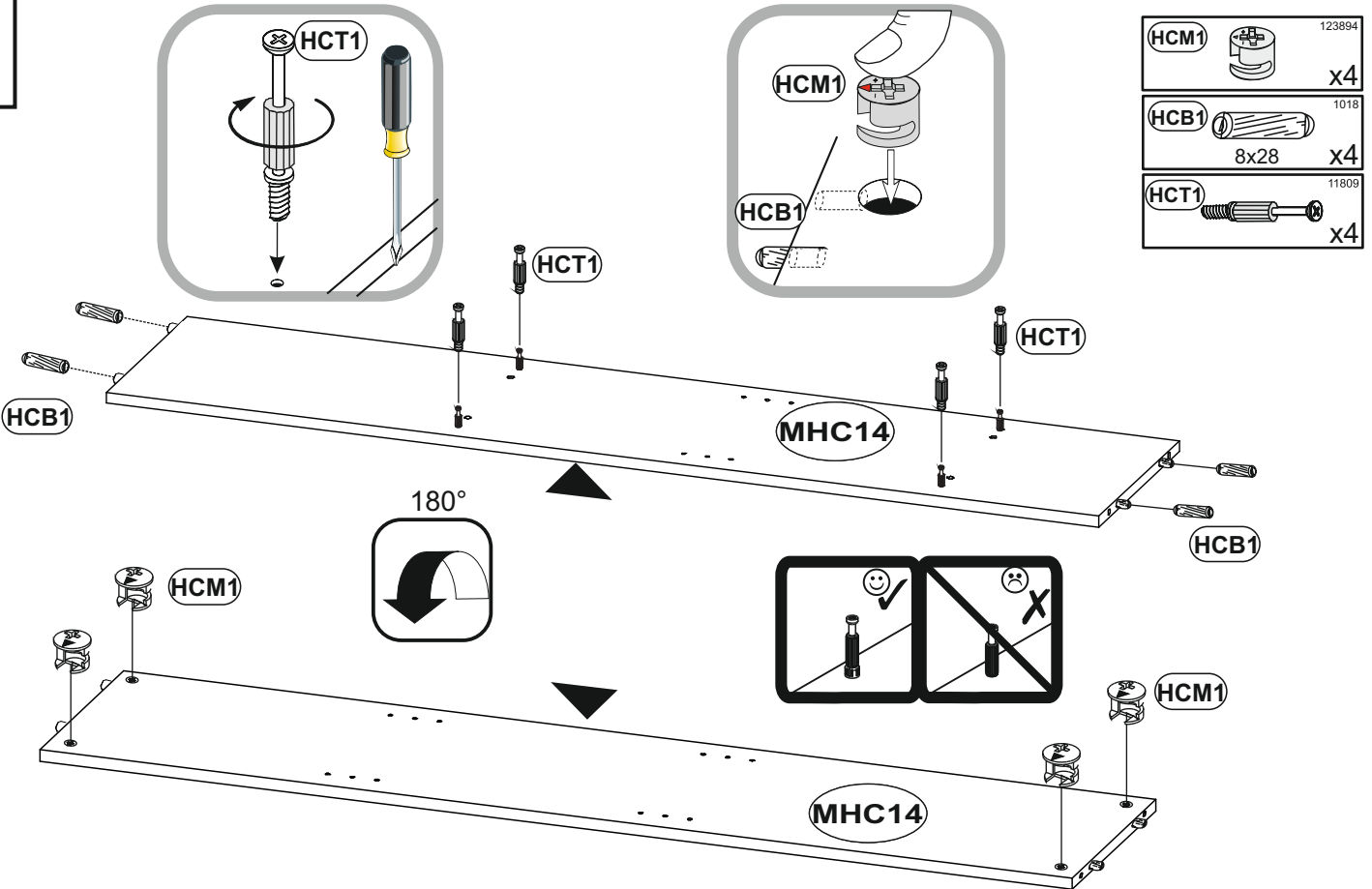

3

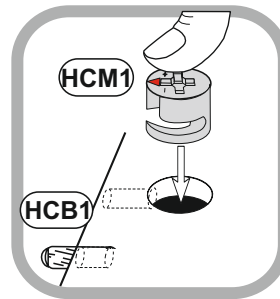
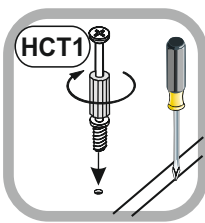
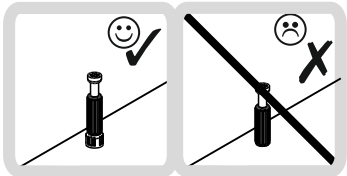

HCM1		123894	x4
HCB1		1018	x4
HCT1		11809	x2

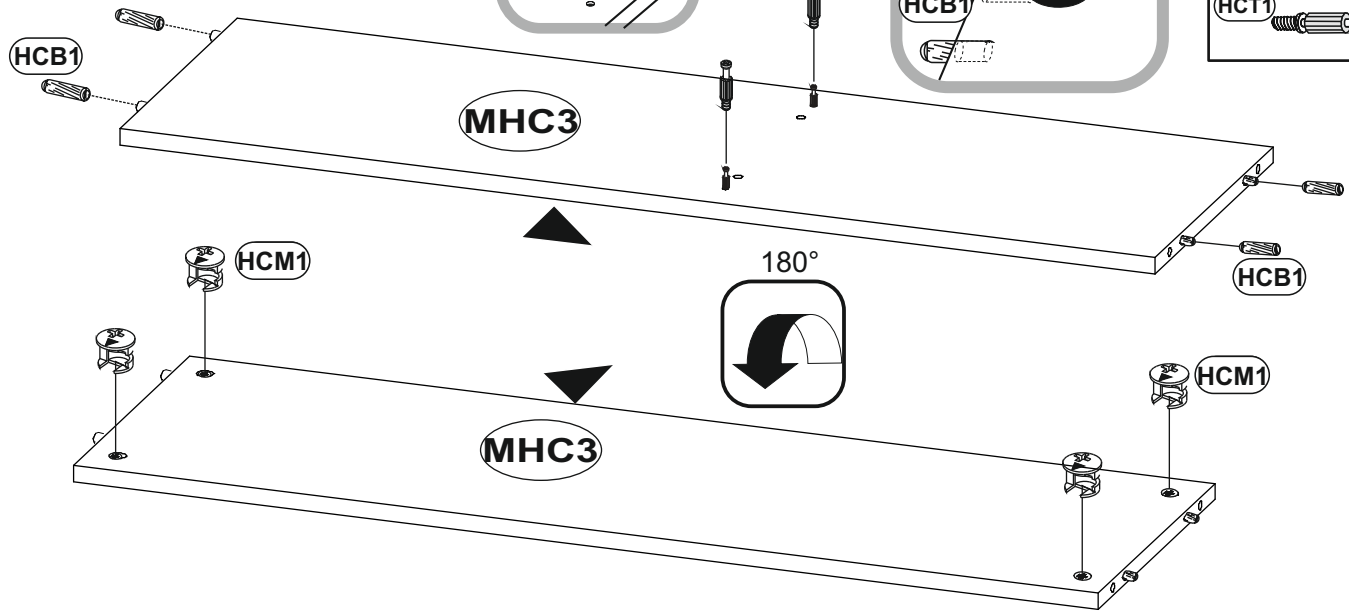

4

HCM1		123894	x8
HCB1		1018	x8

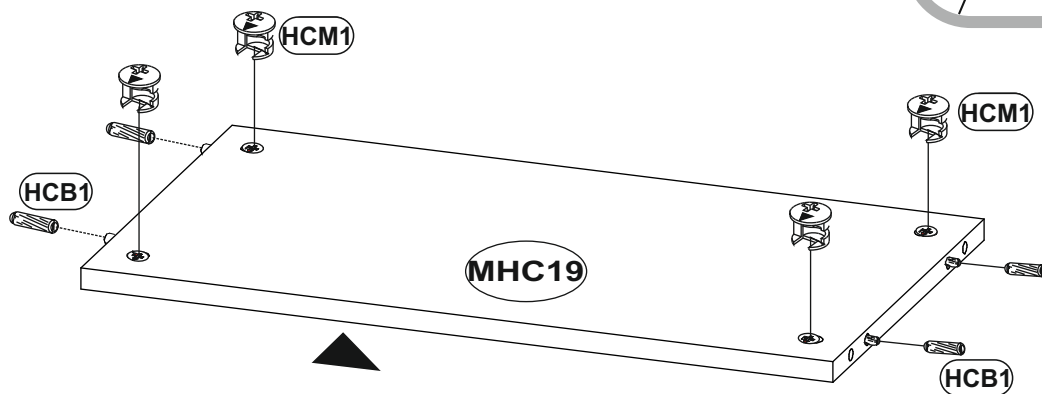
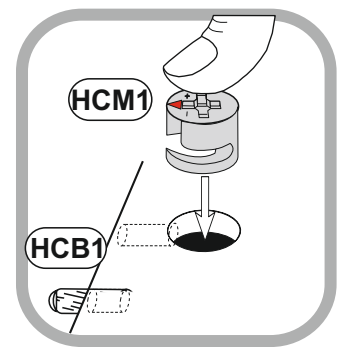
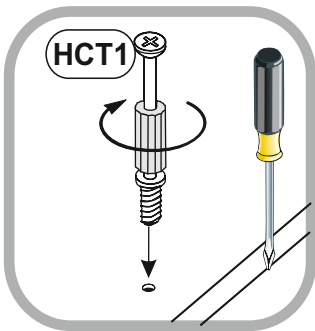
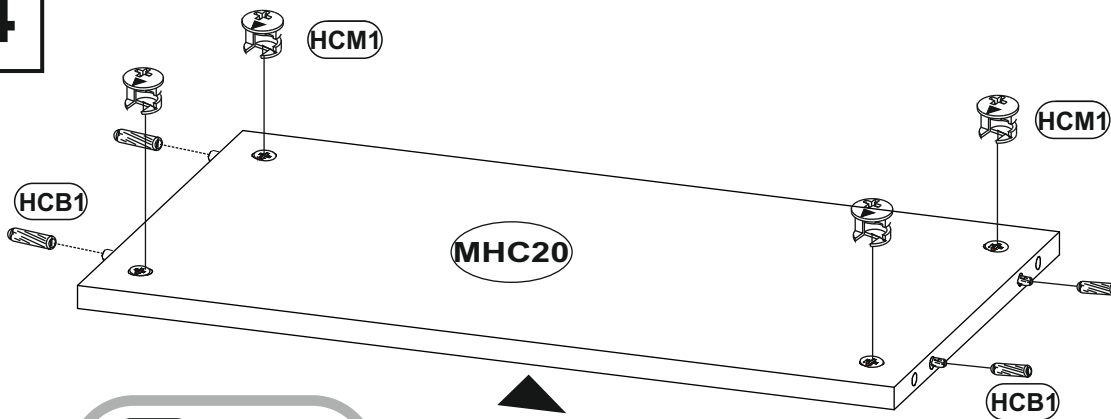

5

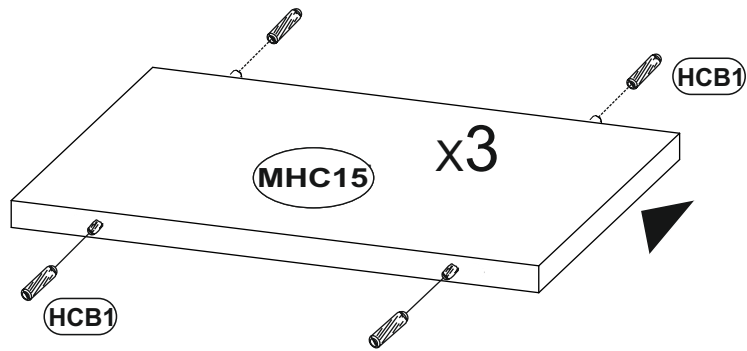

HCB1		1018
	8x28	x12

6

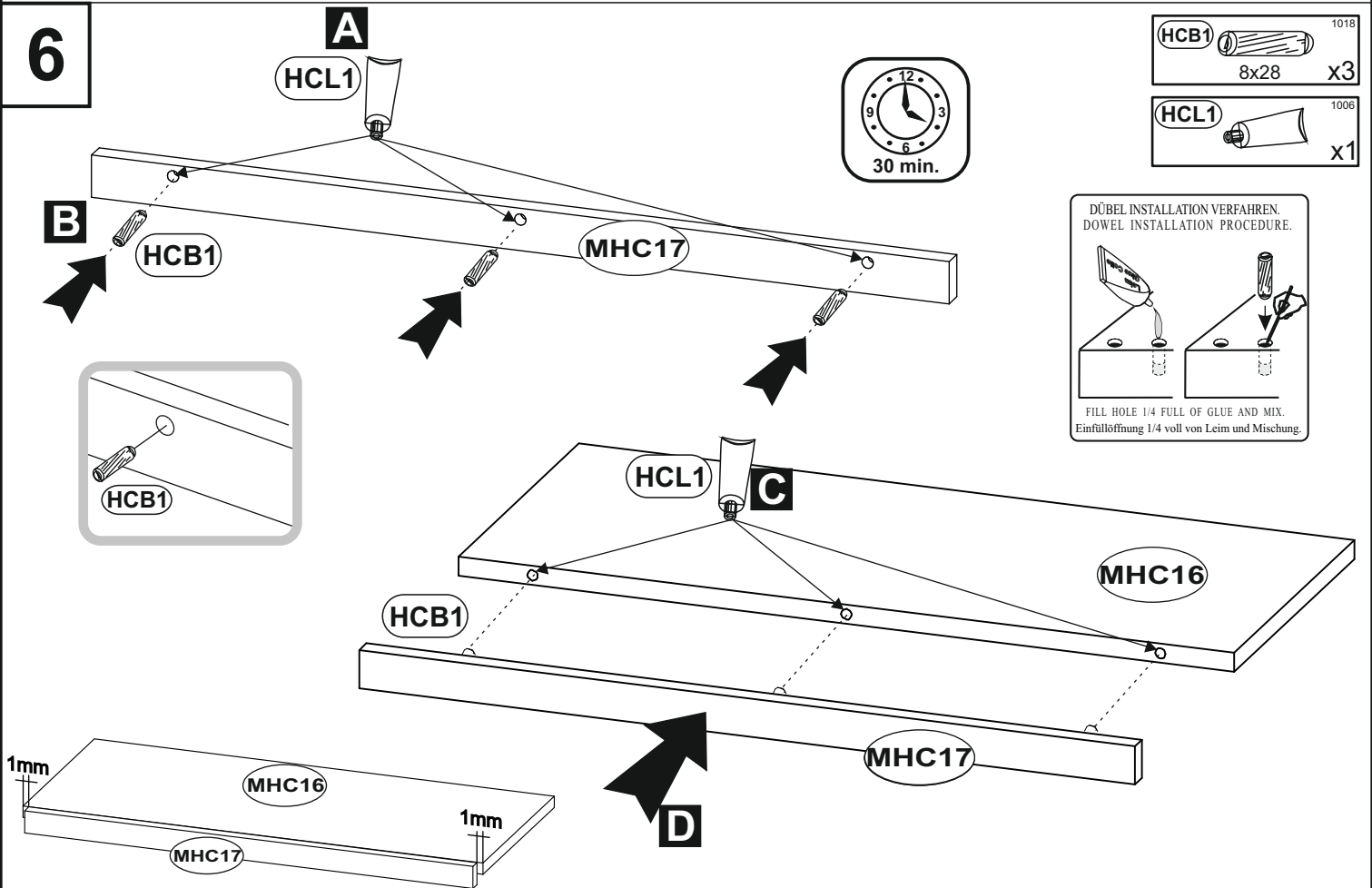

HCB1		1018
	8x28	x3

HCL1		1006
		x1

DÜBEL INSTALLATION VERFAHREN.
DOWEL INSTALLATION PROCEDURE.

FILL HOLE 1/4 FULL OF GLUE AND MIX.
Einfüllöffnung 1/4 voll von Leim und Mischung.

7

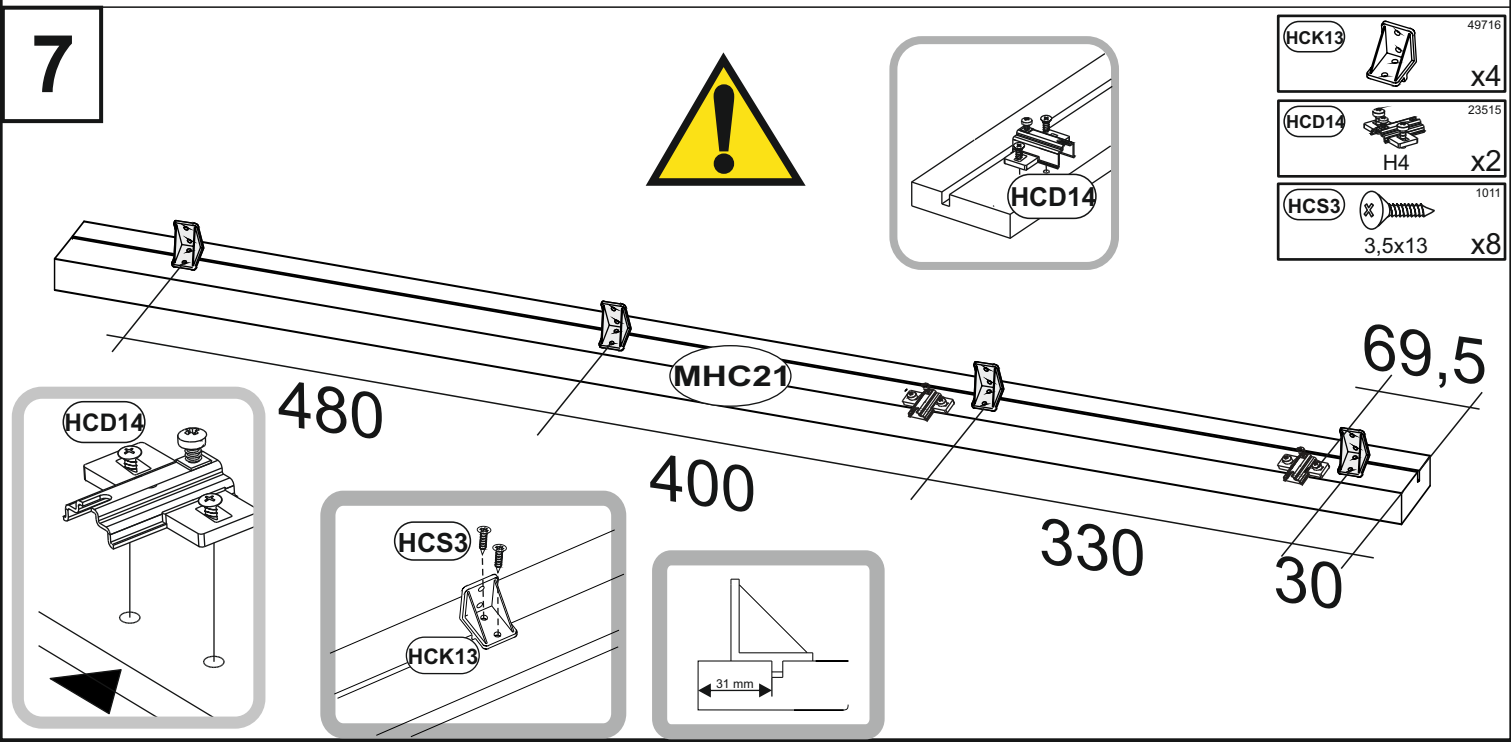

HCK13		49716
		x4

HCD14		23515
	H4	x2

HCS3		1011
	3,5x13	x8

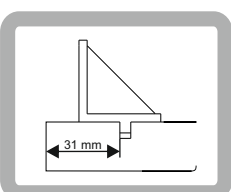
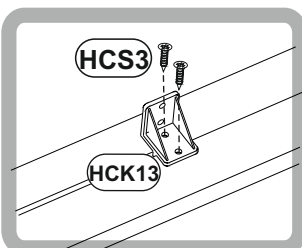
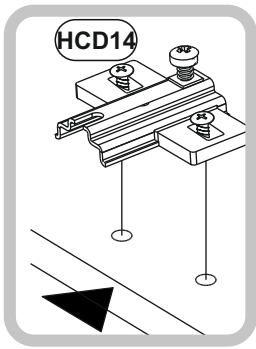
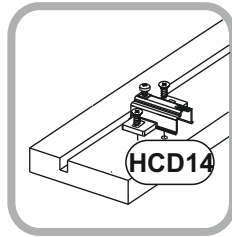

480

400

330

30

69,5

8

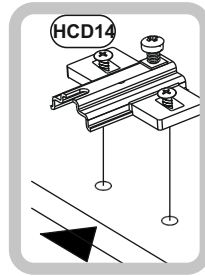
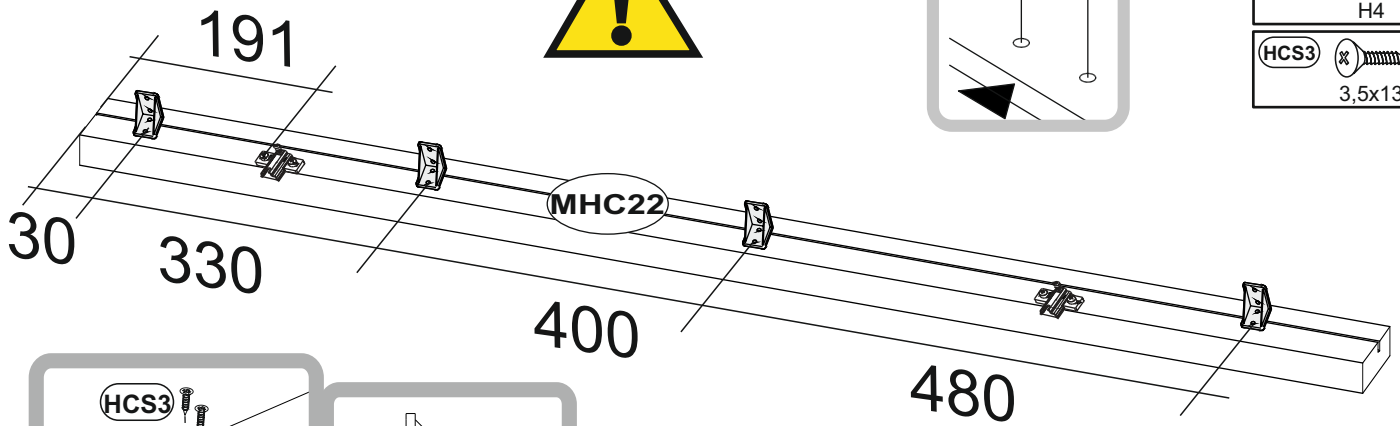

HCK13		49716	x4
HCD14		23515	x2
HCS3		1011	x8
		3,5x13	

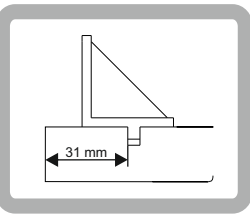
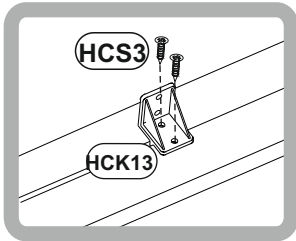

9

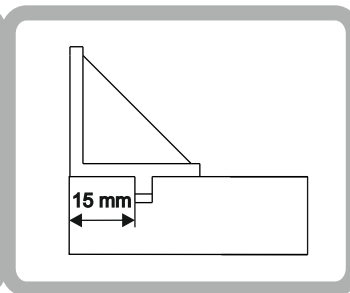
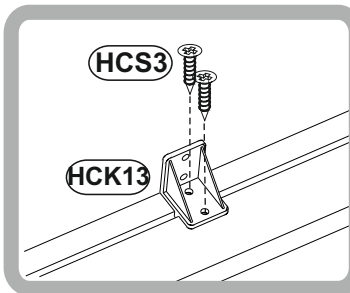

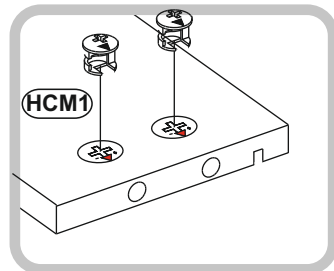
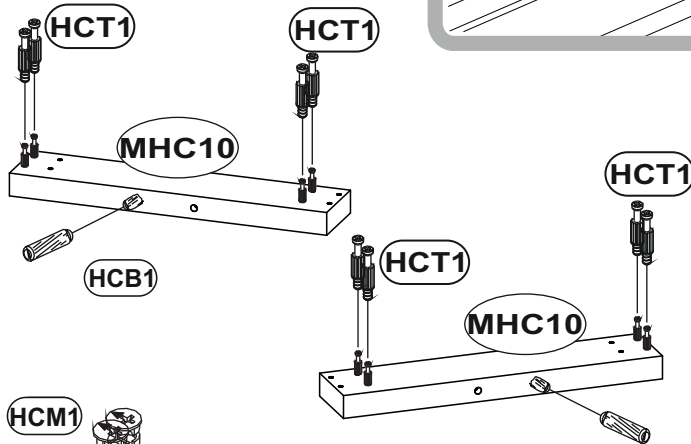

HCM1		123894	x8
HCT1		1336	x8
HCS3		1011	x12
		3,5x13	
HCK13		49716	x6
HCB1		1018	x2
		8x28	

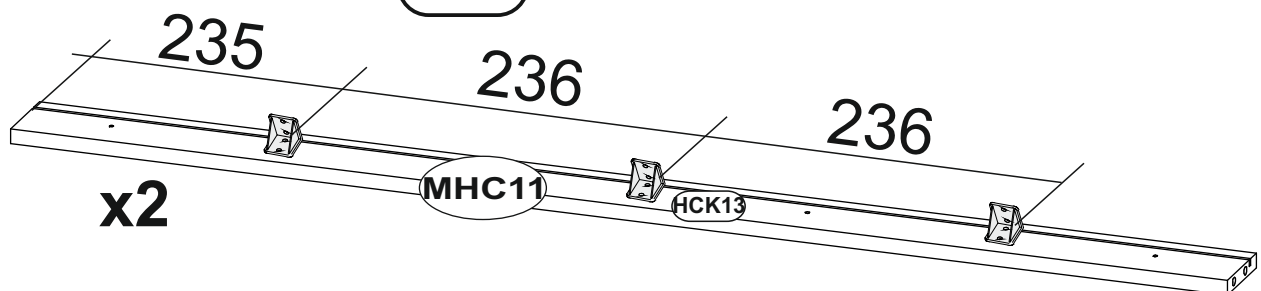
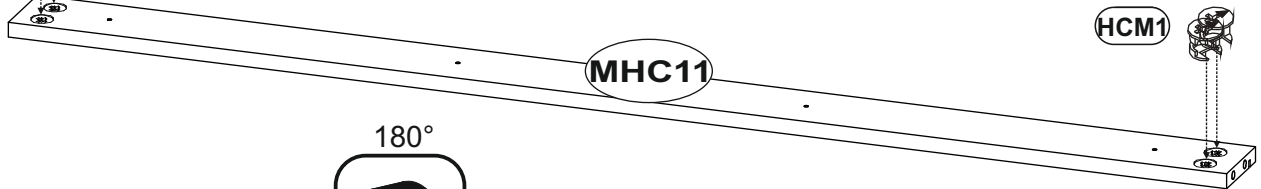

x2

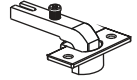

x2

<p>HCF44 116795</p>  <p>x2</p>	<p>HCZ4 49365</p>  <p>φ35 90° x4</p>
<p>HCS3 1011</p>  <p>3,5x13 x8</p>	

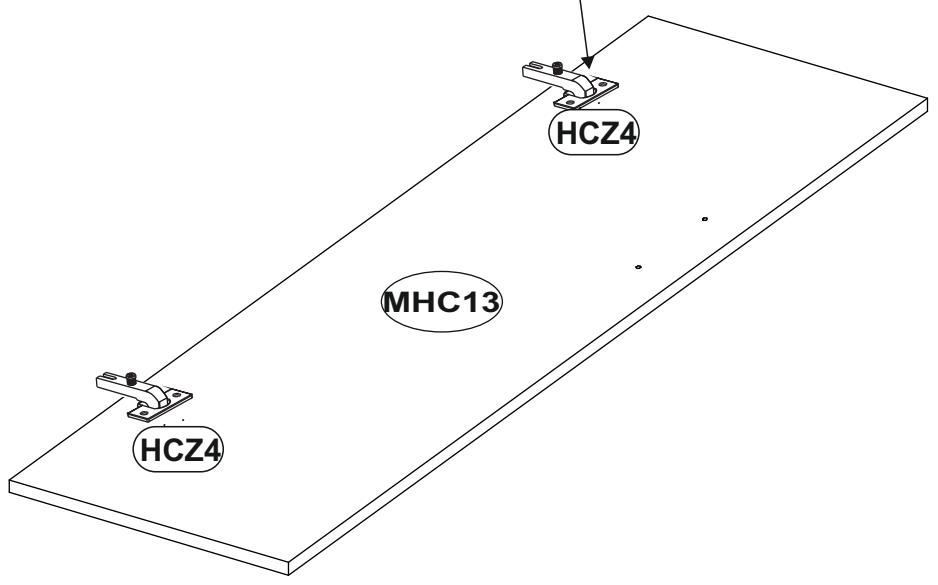
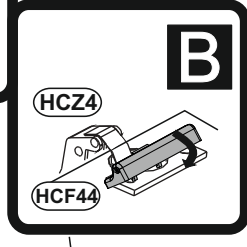
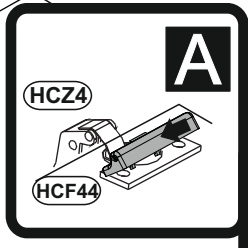
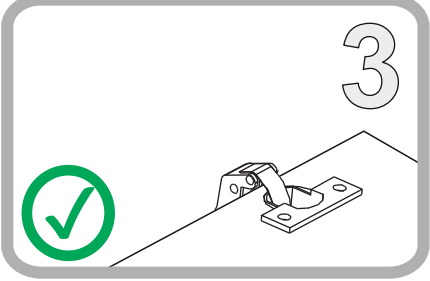
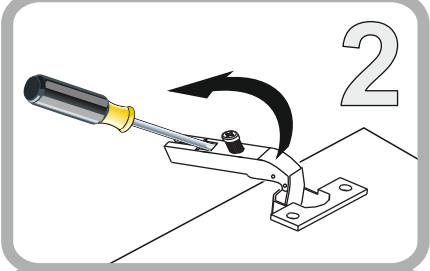
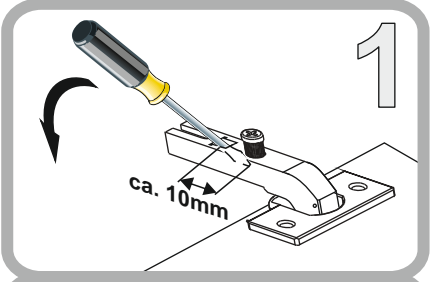
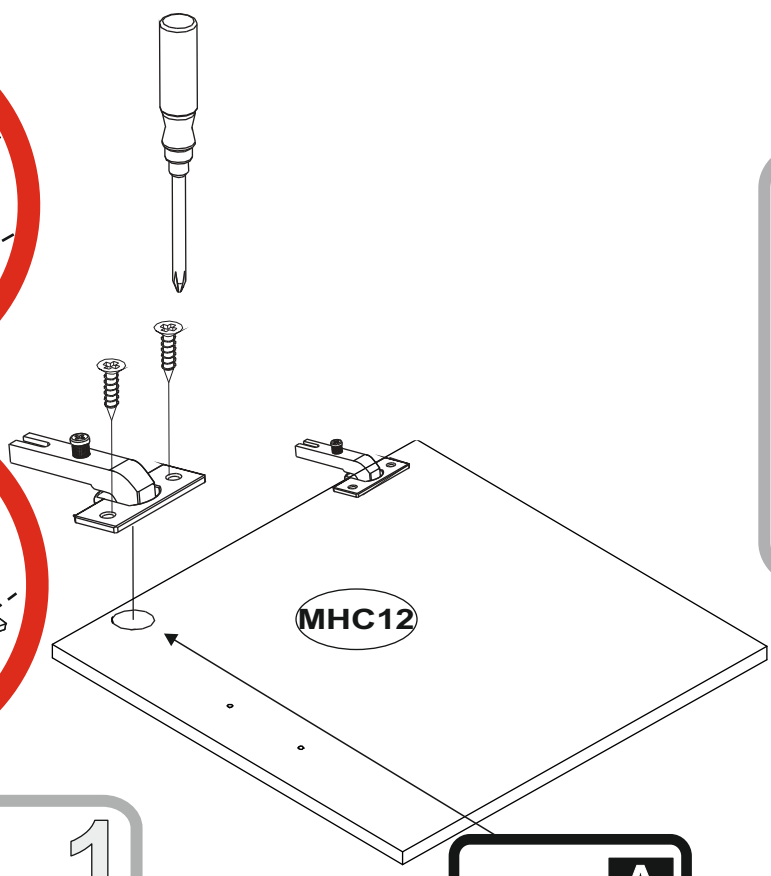
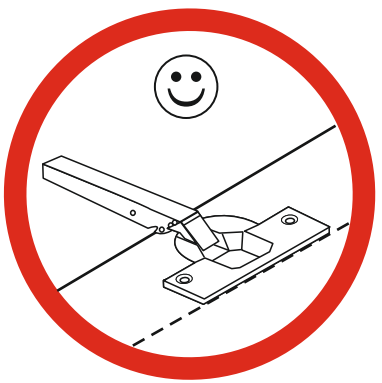

11

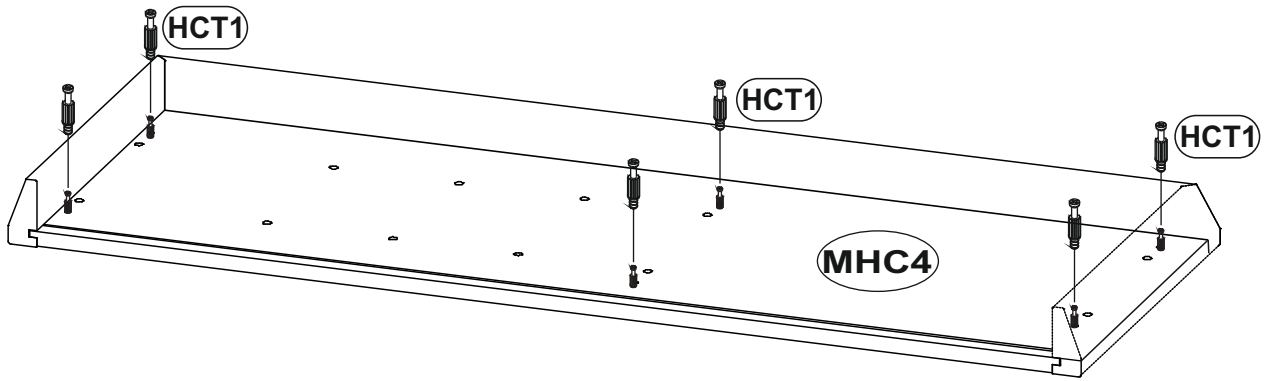
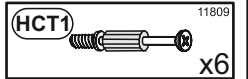

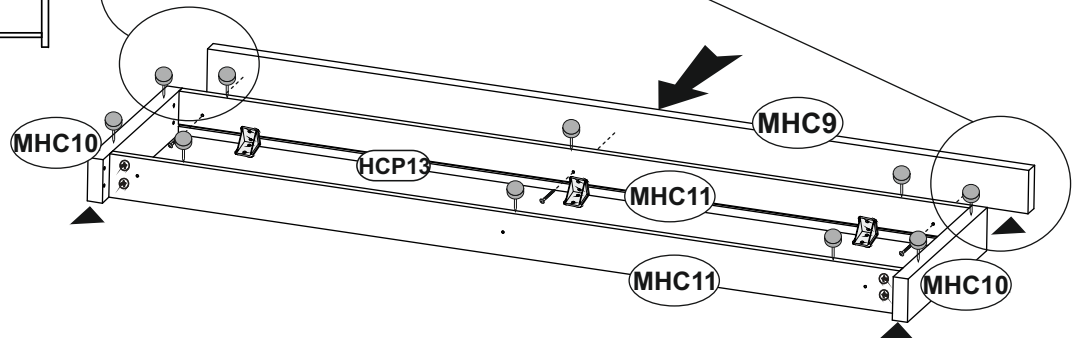
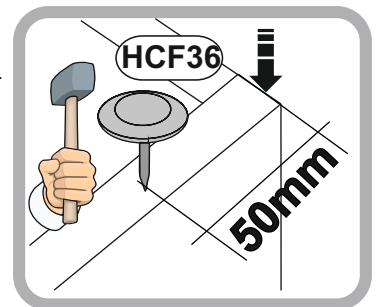
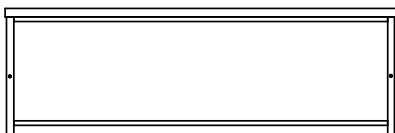
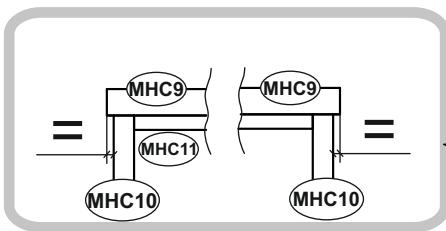
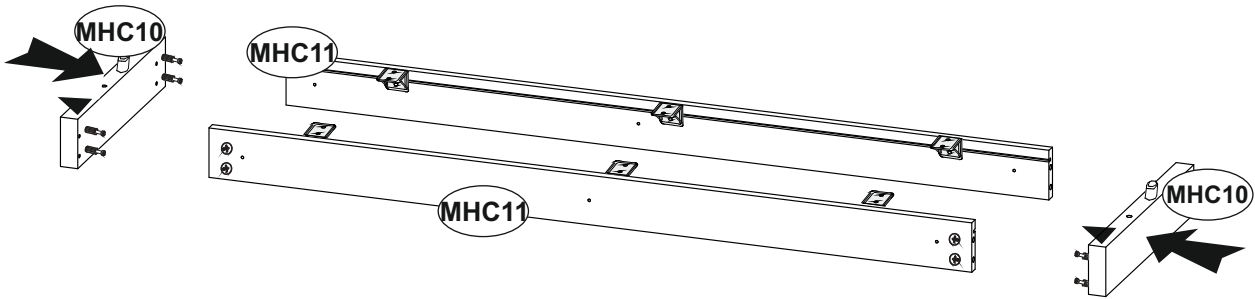
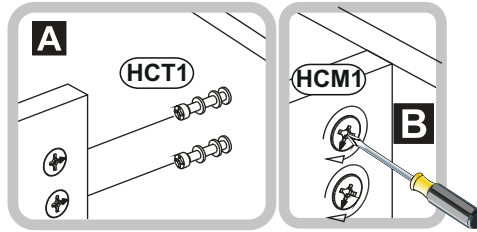
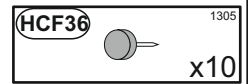
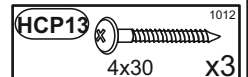

12

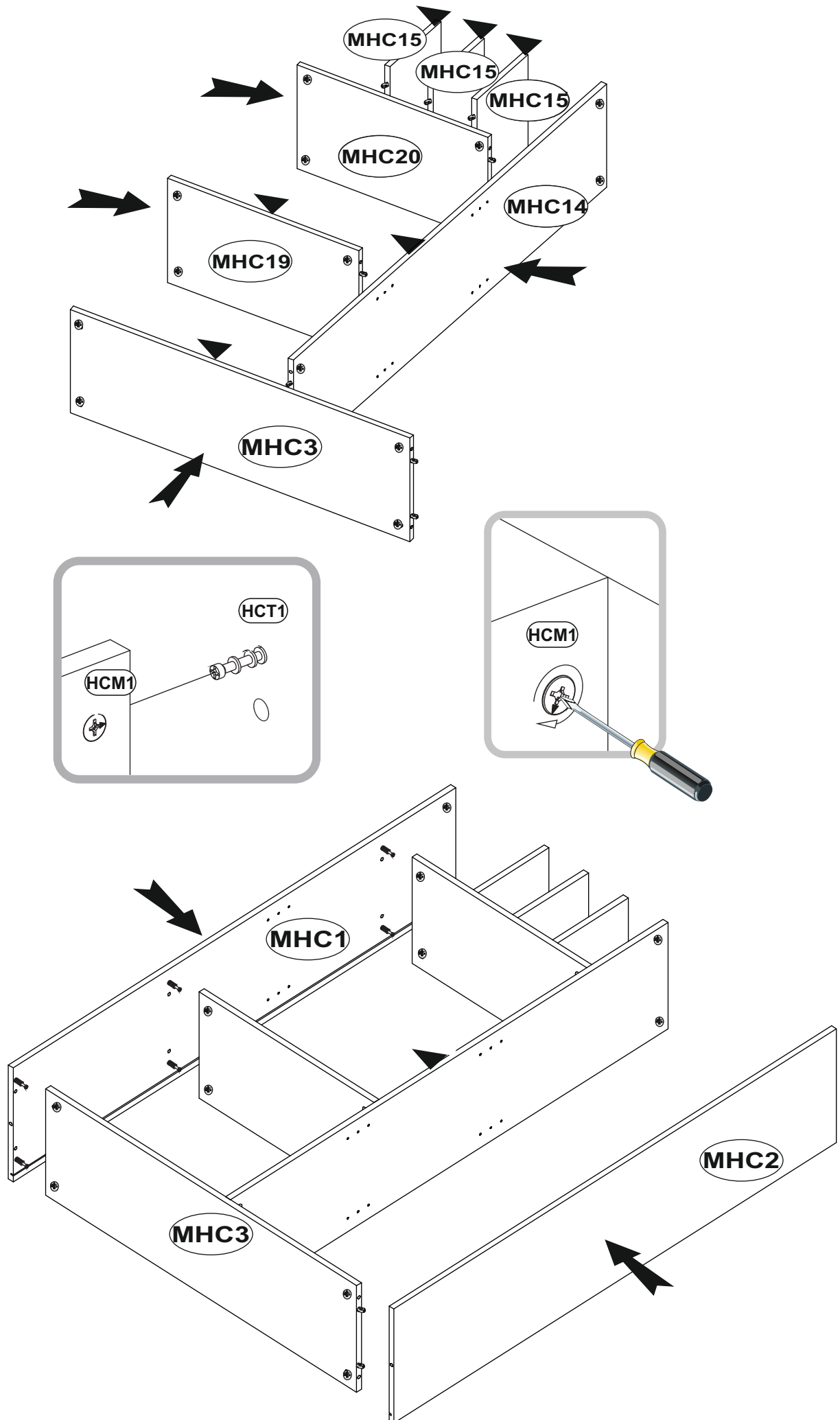

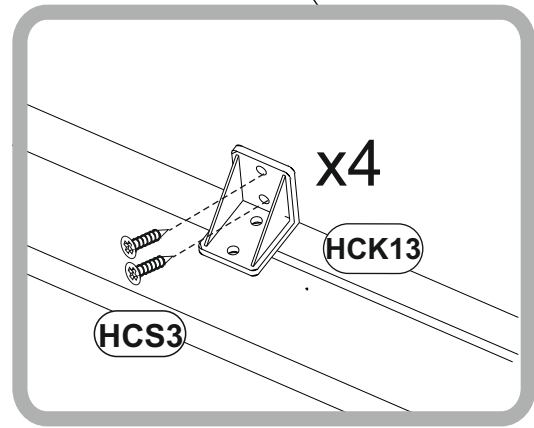
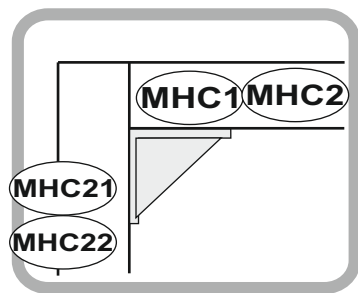
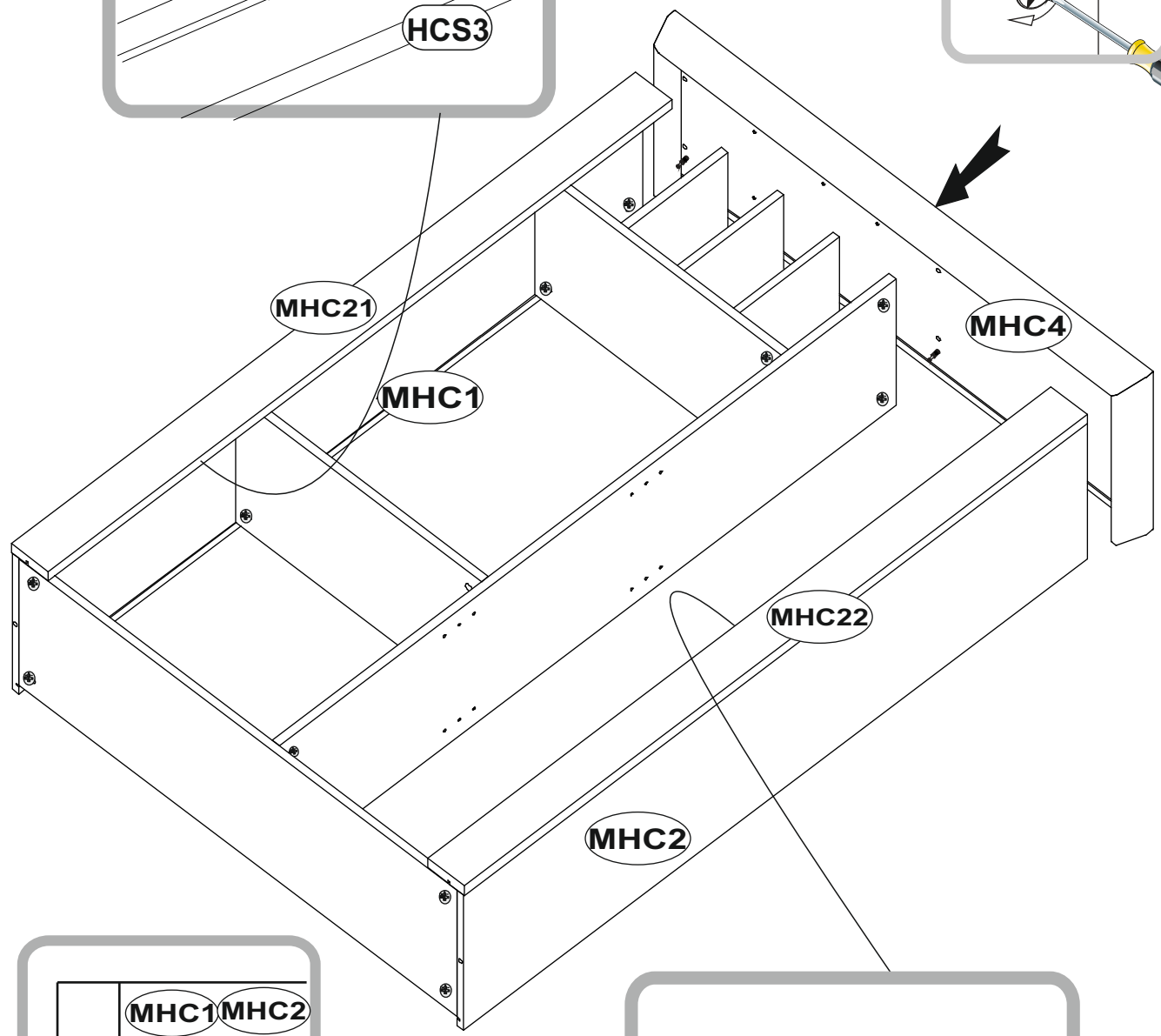
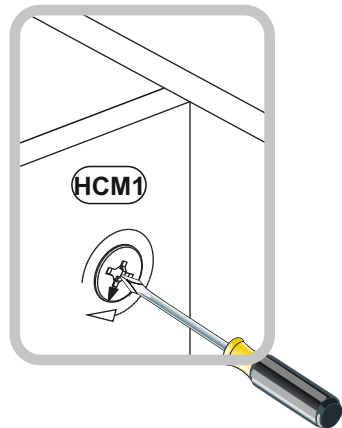
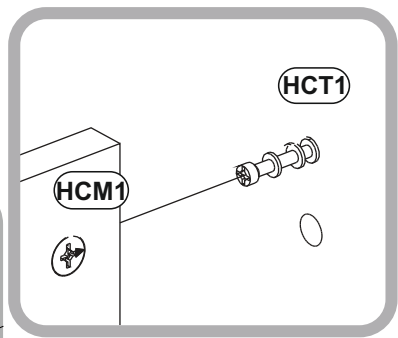
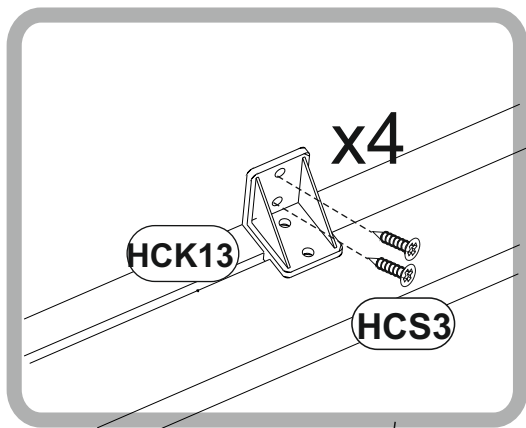



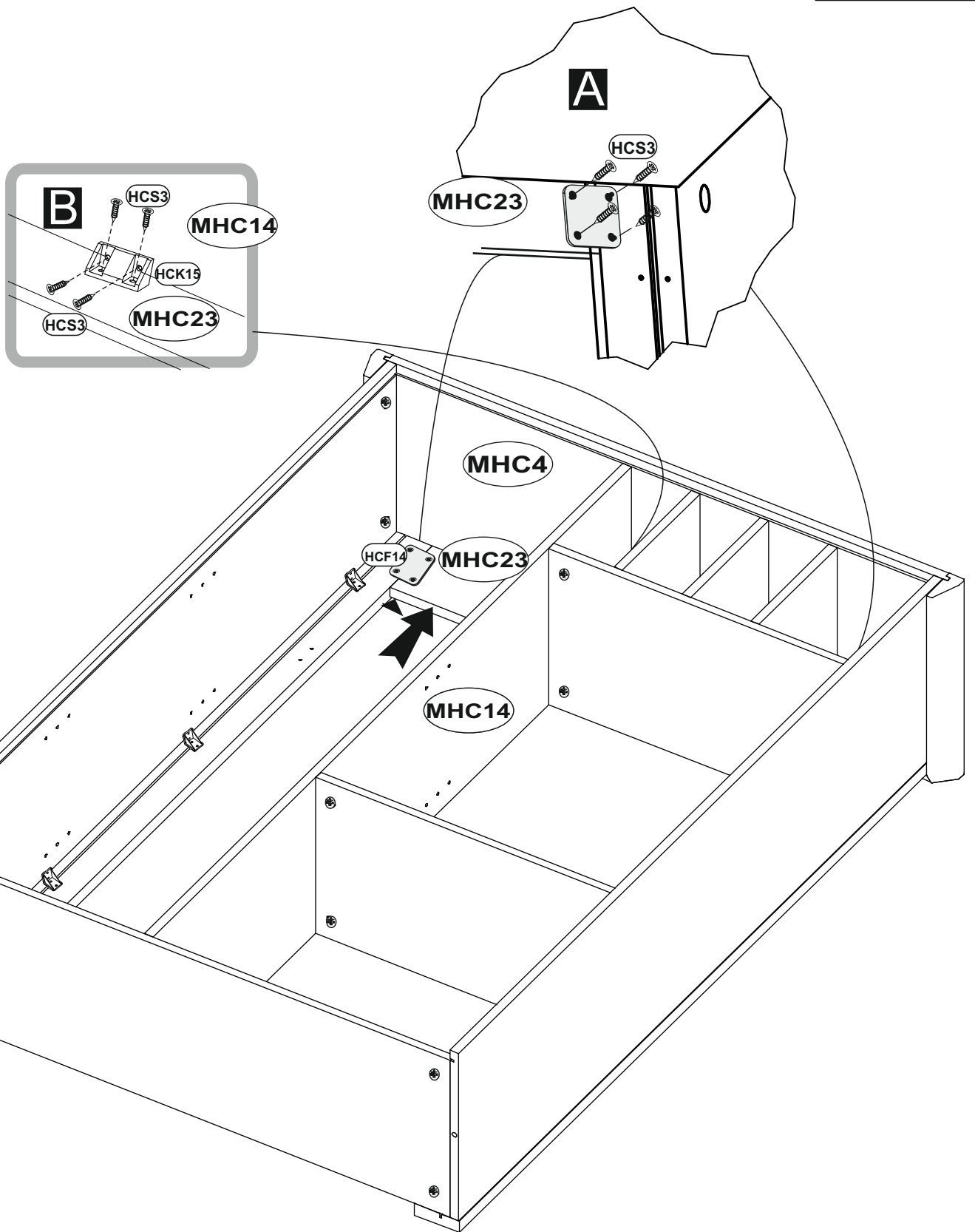

HCK15		81556	HCS3		1011
		x1		3,5x13	x12
HCF14					1021
					x2



HCJ23		1302
		x12
HCF1		1415
		x9
HCP6		1056
		3x20 x16

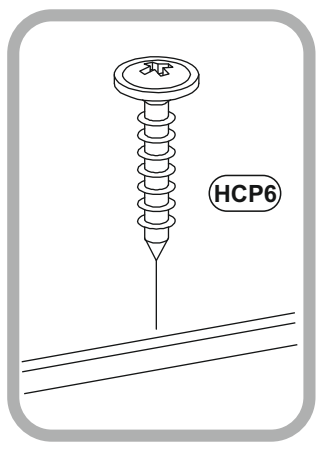
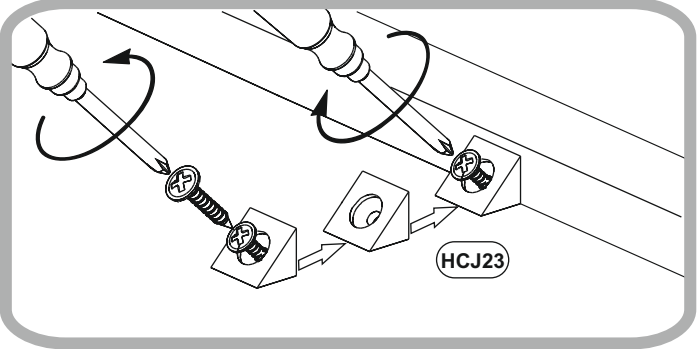
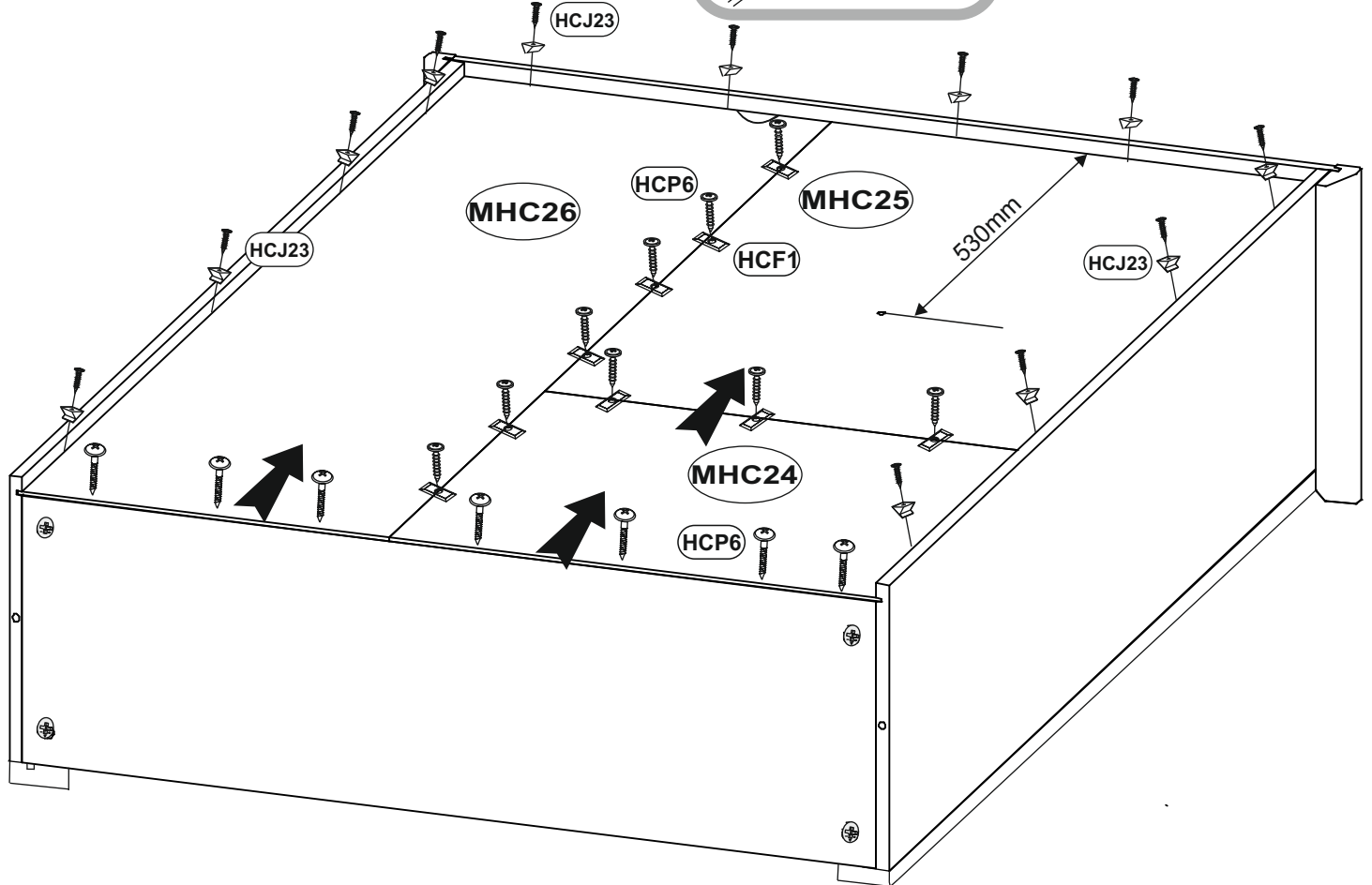
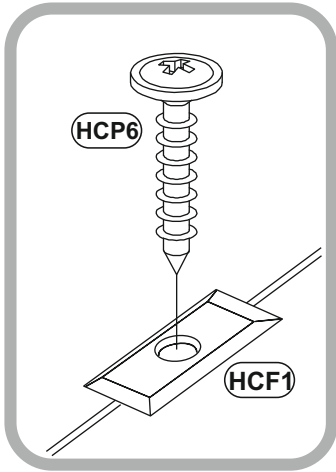

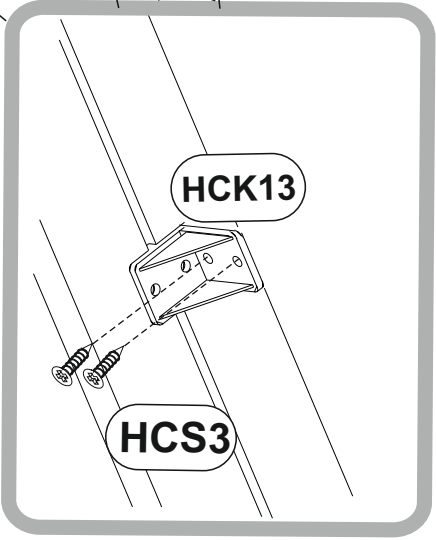
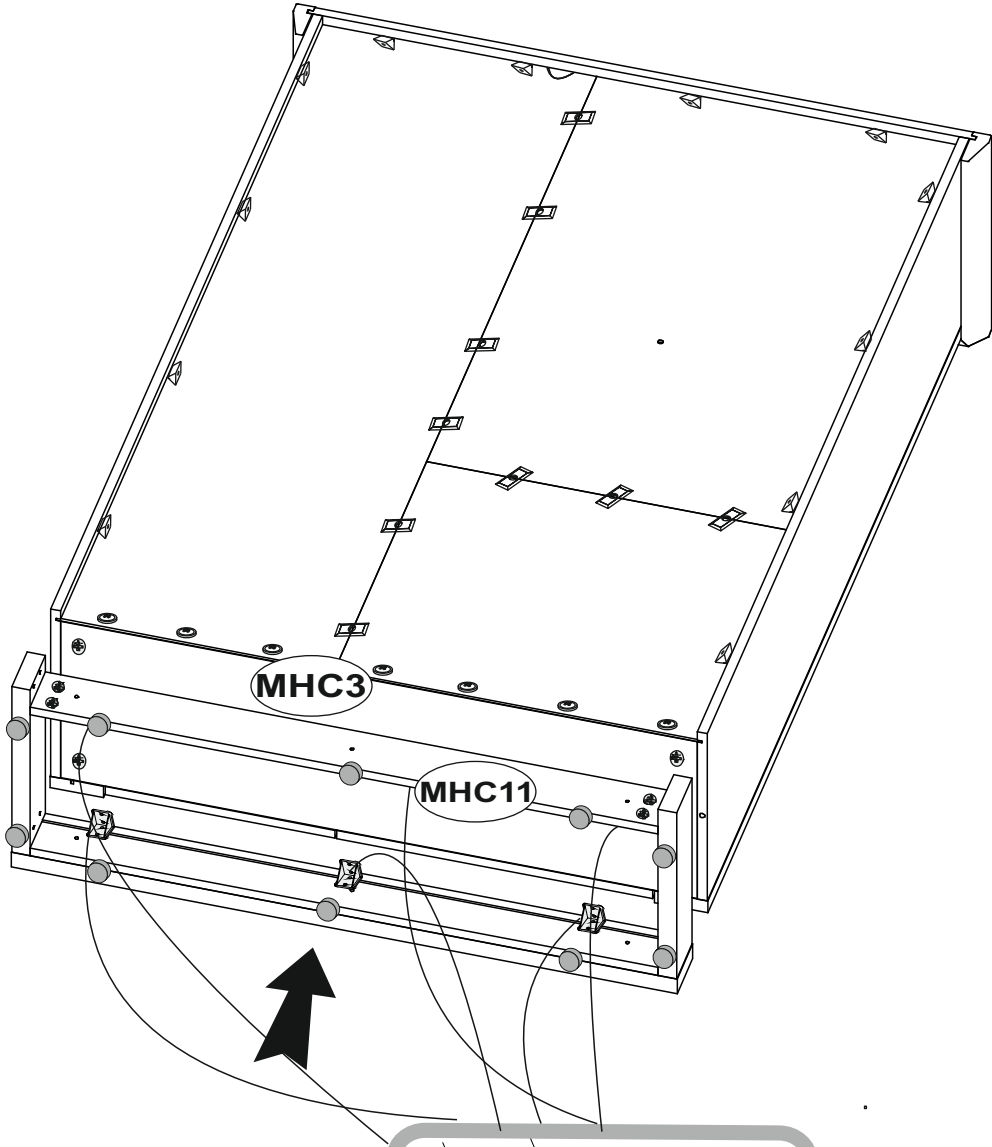

18

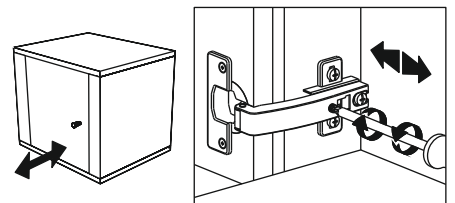
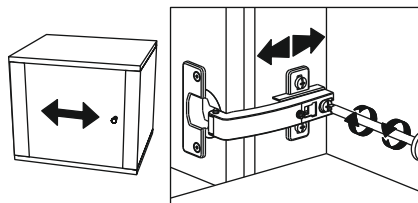
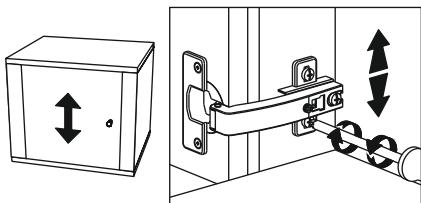
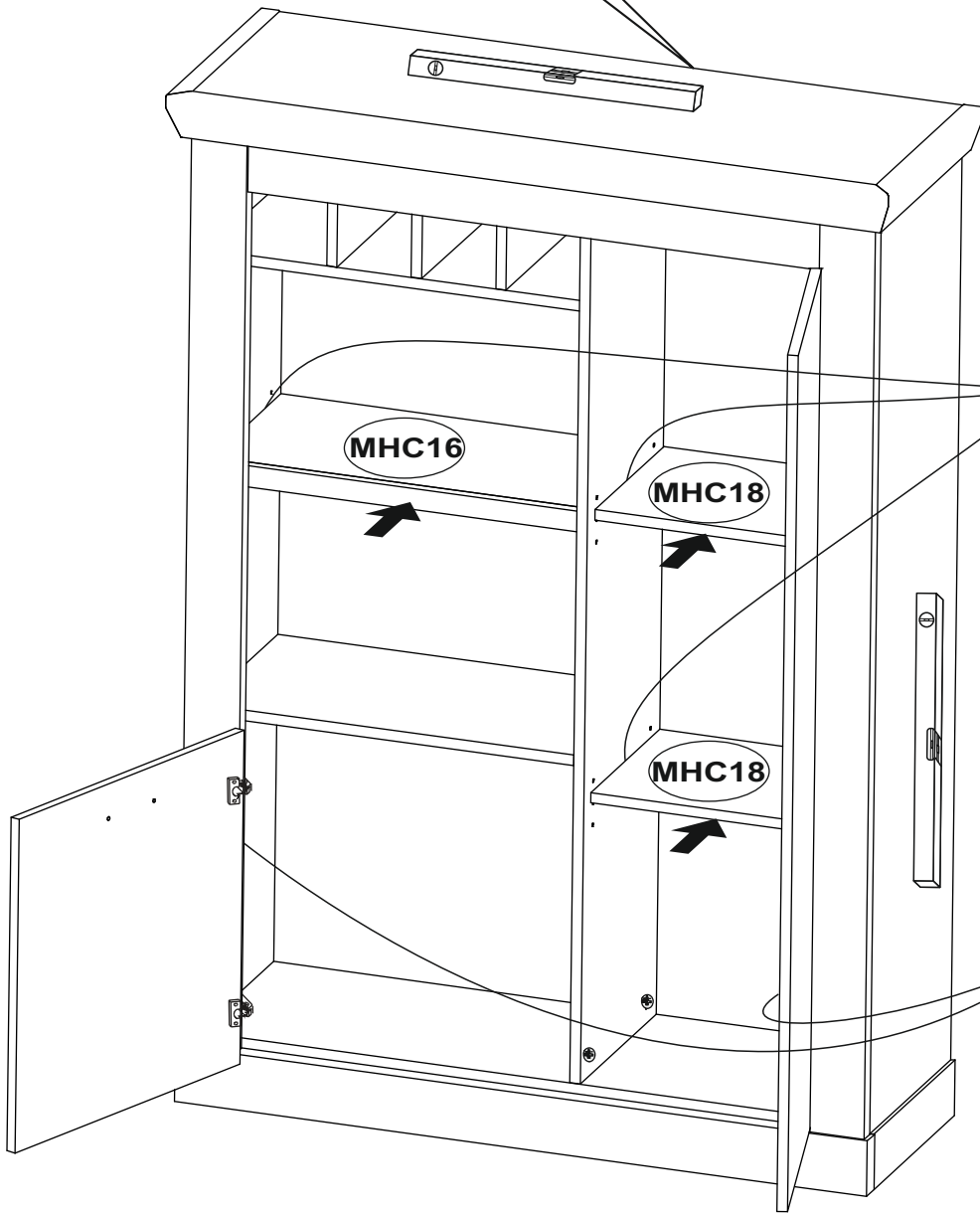
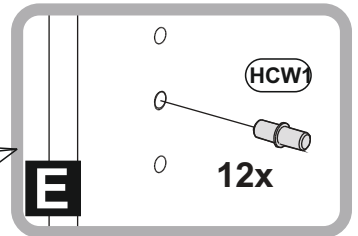
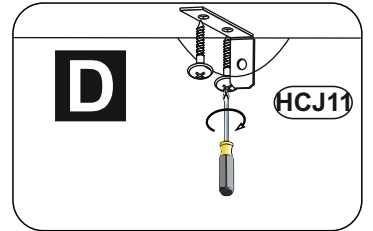
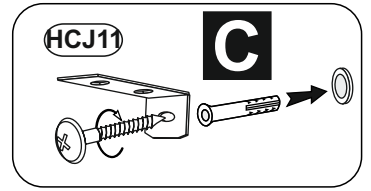
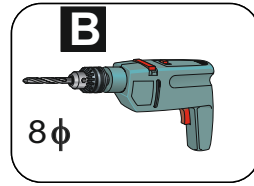
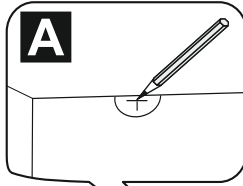
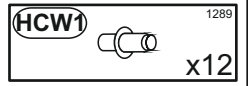
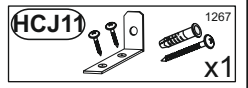
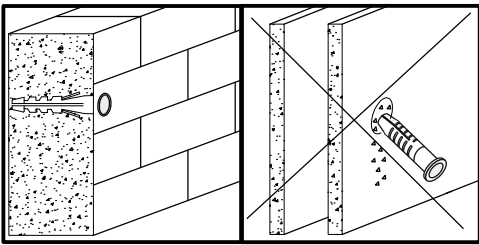

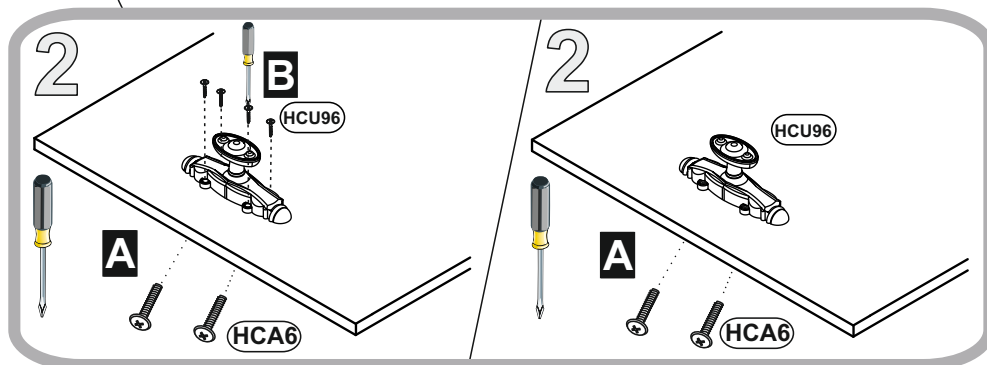
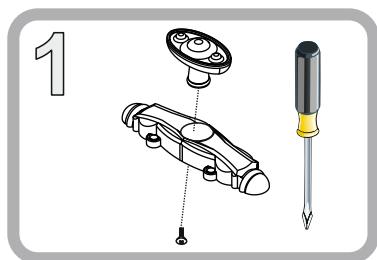
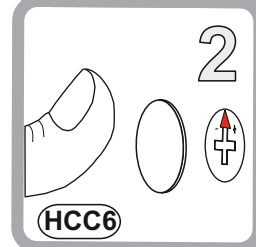
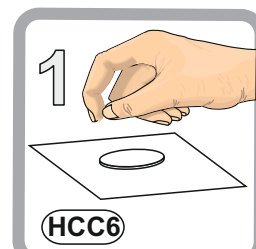
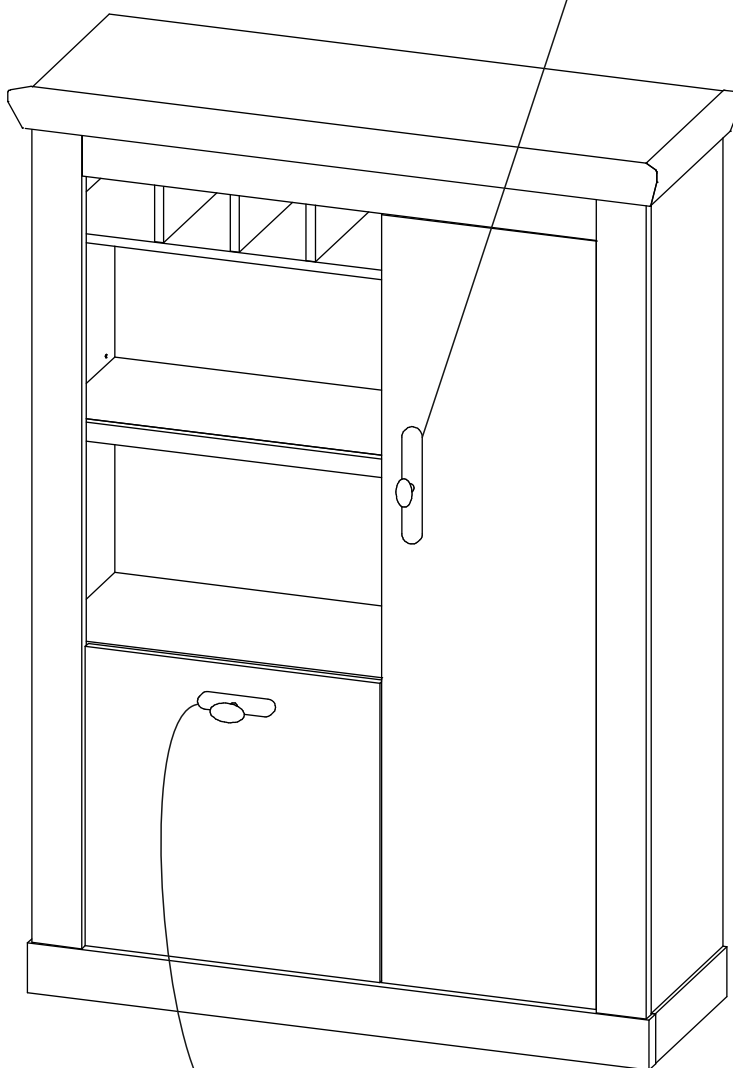
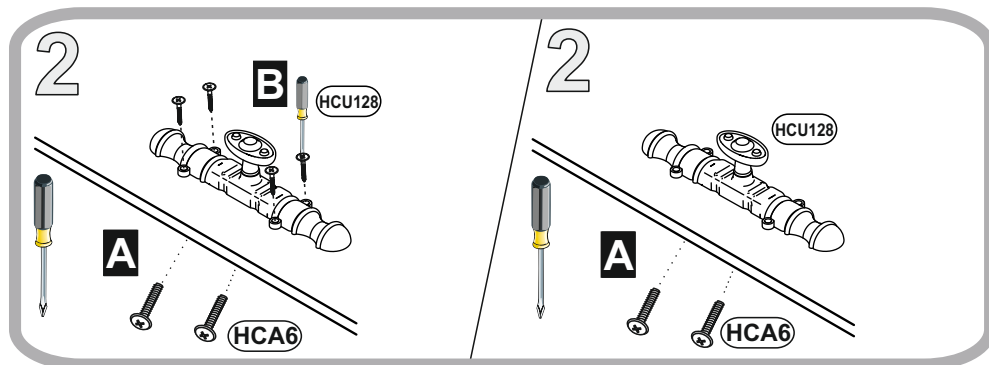
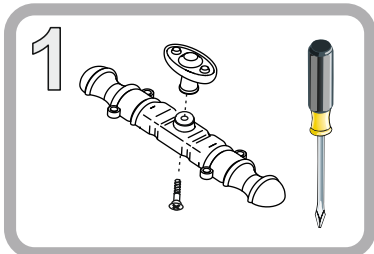
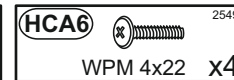
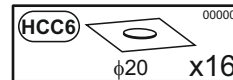
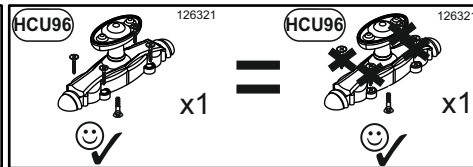
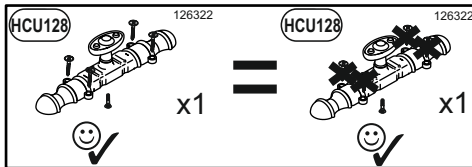

FLORENZ 46M

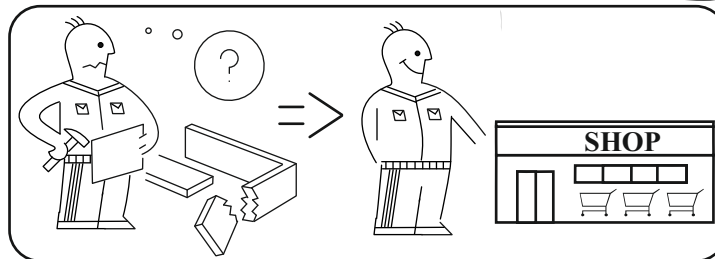
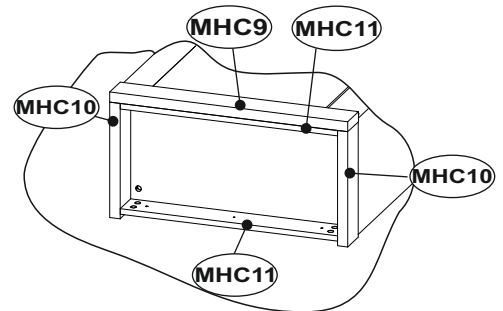
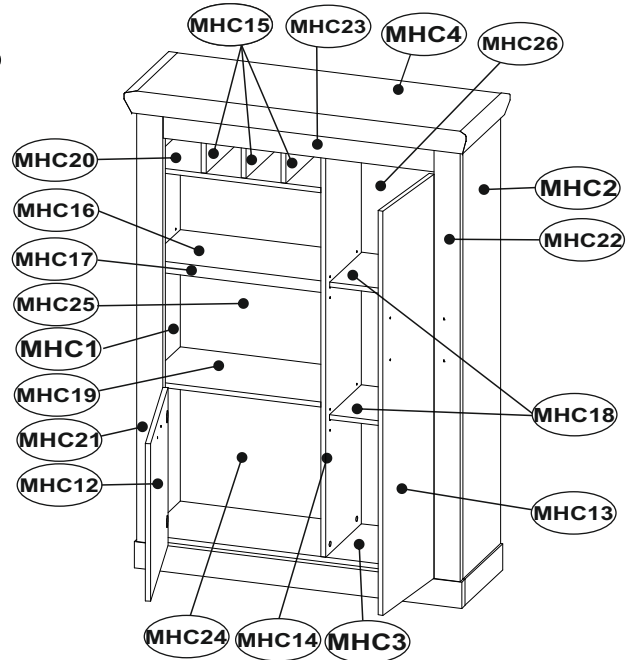
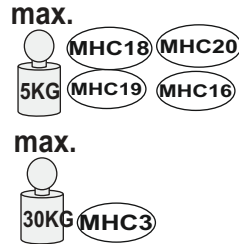

D Unser Direktservice für Beschlagteile
Sollte Ihnen ein Beschlagteil fehlen, können Sie diese Servicekarte direkt an die untenstehende Adresse mailen. Wir können allerdings nur Beschlagteile auf diesem Wege verschicken. Sollten Sie eine andere Beanstandung an Ihrem Möbelstück haben, so wenden Sie sich bitte direkt an Ihr Möbelhaus.

GB Our direct order service for fitting
If a fitting part is missing, you can e-mail this service card directly to the address below. However, we can only send fitting parts in this way. If you have any other cause for complaint concerning your item of furniture, please contact your furniture store directly.

CZ Naše přímé služby pro kování
Chybí-li vám nějaký díl z kování, můžete tuto servisní kartu odeslat e-mailem přímo na níže uvedenou adresu. Touto cestou však můžeme zoslat jen díly kování. Pokud byste reklamovali jiný díl nábytku, obraťte se přímo na svého prodejce nábytku.

F Bien etudier la notice de montage
S'il vous manque une ferrure, veuillez envoyer directement la présente carte service à l'adresse e-mail indiquée ci-dessous. Cependant, ceci nous permet uniquement d'envoyer des ferrures. Pour tout autre type de réclamation concernant votre meuble, veuillez contacter directement votre magasin d'ameublement.

I Il nostro servizio diretto per l'ordine della ferramenta
Qualora Vi dovesse mancare un pezzo di fissaggio, allora Vi preghiamo di inviare questa carta di servizio immediatamente all'indirizzo sottostante. Possiamo inviare i pezzi di fissaggio solamente per mezzo di questo procedimento. Qualora dovete avere qualche altra reclamazione in merito al mobile, allora Vi preghiamo di rivolgerVi direttamente al Vostro Negozio di mobili.

BG Нашата директна услуга за обков
Ако липсват части от комплекта, попълнете настоящата сервисна карта и ни я изпратете на e-mail адреса, посочен по-долу. По този начин можем да доставим само липсващи елементи от обкова. Ако установите други дефекти по мебелите, Ви съветваме да се обърнете към мебелната къща/магазин, от който сте закупили стоката.

NL Onze directservice voor losse onderdelen
Wanneer er een onderdeel ontbreekt, kunt u deze servicekaart direct aan onderstaand e-mailadres sturen. Wij kunnen langs deze weg echter alleen beslagdelen versturen. Mocht u een ander probleem aan uw meubel hebben, verzoeken wij u contact op te nemen met uw meubeldealer.

PL Nasz bezpośredni serwis części montażowych
Jeżeli brakuje części koniecznych do montażu, prosimy o przesłanie nam niniejszej karty serwisowej na niżej podany adres e-mailowy. W ten sposób możemy przesyłać Państwu tylko brakujące części. W przypadku innych reklamacji dotyczących mebla, prosimy zgłosić się do salonu meblowego, w którym został dokonany zakup.

HR Servis za okove
U slučaju da nedostaje neki od dijelova molimo vas da na dolje navedenu mail adresu pošaljete ovaj servisni obrazac. Na ovaj način mogu se dostaviti samo okovi. U slučaju da imate dodatne prigovore vezane uz komad namještaja molimo vas da se obratite izravno trgovini namještaja gdje je isti kupljen.

HU Direktszolgáltatunk vasalatok esetén
Ha hiányzik egy vasalat, ezt a kártyát közvetlenül elküldheti az alább található címre. Azonban csak vasalatokat tudunk így küldeni. Amennyiben másfajta reklamáció áll fenn bútordarabját illetően, forduljon közvetlenül a bűtörházhoz.

SK Naš priamy servis pre časti kovania
Ak by Vám chýbala nejaká časť kovania, môžete poslať túto servisnú kartu poslať e-mailom na nižšie uvedenú adresu. Diely kovania vieme poslať iba týmto spôsobom. Ak by ste mali inú reklamáciu ohľadom Vašho nábytku, obráťte sa priamo na Vašu predajňu nábytku.

SLO Naše direktno uslužbno storitve za okovje
Ce vam manjka kakšno okovje, lahko to servisno kartico pošljete po e-pošti direktno na spodnji naslov. Po tej poti vam lahko pošljemo samo okovje. Če želite reklamirati kakšen drug del pohištva, se obrnite neposredno na vašo trgovino pohištva.

RO Service-ul nostru direct pentru feronerie
În cazul în care vă lipsește o piesă de feronerie puteți să trimiteți direct acest card de service prin e-mail la adresa de mai jos. Noi nu putem expedia piese de feronerie decât pe această cale. Dacă aveți o altă reclamație referitoare la piesa de mobilier, atunci vă rugăm să vă adresați direct la magazinul dvs. de mobilă.

RUS Наш прямой сервис для поставок фурнитуры
Если окажется, что Вам не хватает того или иного элемента фурнитуры, Вы можете отправить сервисную карту по факсу непосредственно на нижеприведенный адрес электронной почты. Однако, таким образом мы можем пересылать лишь фурнитуру. Если же у Вас возникнут иные претензии относительно приобретенной мебели, пожалуйста, обращайтесь непосредственно в организацию, осуществившую продажу.

S Vår direktservice för beslagdelar
Om du saknar en beslagdel kan du skicka detta servicekort direkt till e-postadressen som anges nedan. Tänk på att detta är den enda möjligheten att skicka beslagdelar till dig. Om du vill reklamera din möbel av en annan anledning måste du kontakta ditt möbelhus direkt.

ES Nuestro servicio directo para accesorios
Si le falta algún accesorio, puede enviar esta tarjeta de servicio directamente a la siguiente dirección. No obstante, por este método solo podemos enviar accesorios. Si tiene alguna otra objeción sobre su mueble, consulte directamente con su mueblería.

TR Donatılar için doğrudan servisimiz
Bir donatınız eksikse bu servis kartını doğrudan aşağıda bulunan adrese doğrudan mail yazabilirsiniz. Sadece bu yolla donatıları gönderebiliriz. Mobilyanızda başka şikayetleriniz varsa lütfen doğrudan mobilya satıcınıza danışın.

MHC1	1361	320	15	2/2	MHC17	535	30	16	1/2
MHC2	1361	320	15	2/2	MHC18	402	267	15	1/2
MHC3	956	299	15	1/2	MHC19	538	299	15	1/2
MHC4	1044	370,5	65	1/2	MHC20	538	299	15	1/2
MHC9	1000	80	28	1/2	MHC21	1361	80	22	2/2
MHC10	317	80	28	1/2	MHC22	1361	80	22	2/2
MHC11	943	80	15	1/2	MHC23	828	120	18	1/2
MHC12	481	474	15	2/2	MHC24	478	551	3	2/2
MHC13	1235	345	15	2/2	MHC25	888	551	3	2/2
MHC14	1346	299	15	2/2	MHC26	1366	417	3	2/2
MHC15	219	297	15	1/2					
MHC16	537	267	15	1/2					

FLORENZ 46M

Unser Direktservice für Beschlagteile

Sollte Ihnen ein Beschlagteil fehlen, können Sie diese Servicekarte direkt an die untenstehende Adresse mailen. Wir können allerdings nur Beschlagteile auf diesem Wege verschicken. Sollten Sie eine andere Beanstandung an Ihrem Möbelstück haben, so wenden Sie sich bitte direkt an Ihr Möbelhaus.

Our direct order service for fitting

If a fitting part is missing, you can e-mail this service card directly to the address below. However, we can only send fitting parts in this way. If you have any other cause for complaint concerning your item of furniture, please contact your furniture store directly.

Naše přímé služby pro kování

Chybí-li vám nějaký díl z kování, můžete tuto servisní kartu odeslat e-mailem přímo na níže uvedenou adresu. Touto cestou však můžeme zaslát jen díly kování. Pokud byste reklamovali jiný díl nábytku, obraťte se přímo na svého prodejce nábytku.

Bien étudier la notice de montage

Si l'un vous manque une ferrure, veuillez envoyer directement la présente carte service à l'adresse e-mail indiquée ci-dessous. Cependant, ceci nous permet uniquement d'envoyer des ferrures. Pour tout autre type de réclamation concernant votre meuble, veuillez contacter directement votre magasin d'ameublement.

Il nostro servizio diretto per l'ordine della ferramenta

Qualora Vi dovesse mancare un pezzo di fissaggio, allora Vi preghiamo di inviare questa carta di servizio immediatamente all'indirizzo sottostante. Possiamo inviare i pezzi di fissaggio solamente per mezzo di questo procedimento. Qualora dovete avere qualche altra reclamazione in merito al mobile, allora Vi preghiamo di rivolgerVi direttamente al Vostro Negozio di mobili.

Нашата директна услуга за обков

Ако липсват части от комплекта, попълнете настоящата сервисна карта и ни я изпратете на e-mail адреса, посочен по-долу. По този начин можем да доставяме само липсващи елементи от обкова. Ако установите други дефекти по мебелите, Ви съветваме да се обвърнете към мебелната къща/магазин, от който сте закупили стоката.

Onze directservice voor losse onderdelen

Wanneer er een onderdeel ontbreekt, kunt u deze servicekaart direct aan onderstaand e-mailadres sturen. Wij kunnen langs deze weg echter alleen beslagdelen versturen. Mocht u een ander probleem aan uw meubel hebben, verzoeken wij u contact op te nemen met uw meubeldealer.

Nasz bezpośredni serwis części montażowych

Jeżeli brakuje części koniecznych do montażu, prosimy o przesłanie nam niniejszej karty serwisowej na niżej podany adres e-mailowy. W ten sposób możemy przesałać Państwu tylko brakujące części. W przypadku innych reklamacji dotyczących mebla, prosimy zgłosić się do salonu meblowego, w którym został dokonany zakup.

Servis za okove

U slučaju da nedostaje neki od dijelova molimo vas da na doje navedenu mail adresu pošaljete ovaj servisni obrazac. Na ovaj način mogu se dostaviti samo okovi. U slučaju da imate dodatne prigovore vezane uz komad namještaja molimo vas da se obratite izravno trgovini namještaja gdje je isti kupljen.

Direktszoigálatunk vasalatok esetén

Ha hiányzik egy vasalat, ezt a kártyát közvetlenül elküldheti az alább található címre. Azonban csakhis vasalatokat tudunk így küldeni. Amennyiben másfajta reklamáció áll fenn bútordarabját illetően, forduljon közvetlenül a bútordáchoz.

Náš priamy servis pre časti kovania

Ak by Vám chýbala nejaká časť kovania, môžete poslať túto servisnú kartu pošlat e-mailom na nižšie uvedenú adresu. Diely kovania vieme poslať iba týmto spôsobom. Ak by ste mali inú reklamáciu ohľadom Vašho nábytku, obráťte sa priamo na Vašu predajňu nábytku.

Naše direktne uslužne storitve za okovje

Če vam manjka kakšno okovje, lahko to servisno kartico pošljete po e-pošti direktno na spodnji naslov. Po tej poti vam lahko pošljemo samo okovje. Če želite reklamirati kakšen drug del pohištva, se obrnite neposredno na vašo trgovino pohištva.

Service-ul nostru direct pentru feronerie

În cazul în care vă lipsește o piesă de feronerie puteți să trimiteți direct acest card de service prin e-mail la adresa de mai jos. Noi nu putem expedia piese de feronerie decât pe această cale. Dacă aveți o altă reclamație referitoare la piesa de mobilier, atunci vă rugăm să vă adresați direct la magazinul dvs. de mobilier.

Наш прямой сервис для поставок фурнитуры

Если окажется, что Вам не хватает того или иного элемента фурнитуры, Вы можете отправить сервисную карту по факсу непосредственно на нижеприведенный адрес электронной почты. Однако, таким образом мы можем пересылать лишь фурнитуру. Если же у Вас возникнут иные претензии относительно приобретенной мебели, пожалуйста, обращайтесь непосредственно в организацию, осуществившую продажу.

Vir direktservice för beslagdelar

Om du saknar en beslagdel kan du skicka detta servicekort direkt till e-postadressen som anges nedan. Tänk på att detta är den enda möjligheten att skicka beslagdelar till dig. Om du vill reklamera din möbel av en annan anledning måste du kontakta ditt möbelhus direkt.

Nuestro servicio directo para accesorios

Si le falta algún accesorio, puede enviar esta tarjeta de servicio directamente a la siguiente dirección. No obstante, por este método solo podemos enviar accesorios. Si tiene alguna otra objeción sobre su mueble, consulte directamente con su mueblería.

Donatilar için doğrudan servisimiz

Bir donatılar eksikliği bu servis kartını doğrudan aşağıda bulunan adrese doğrudan mail yazabilirsiniz. Sadece bu yolla donatıları gönderiliriz. Mobilyanızda başka şikayetleriniz varsa lütfen doğrudan mobilya satıcınıza danışın.

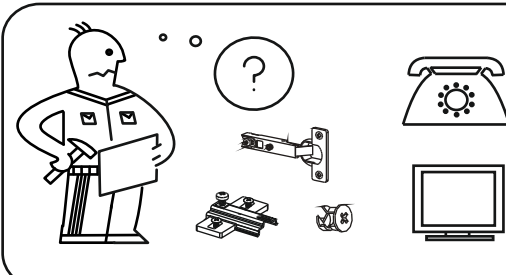
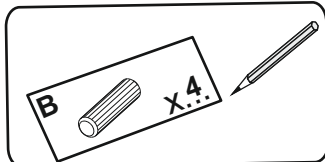
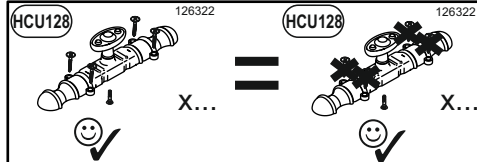
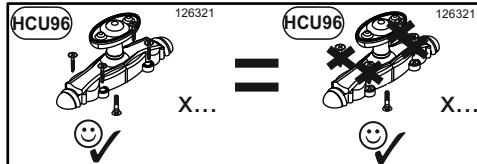
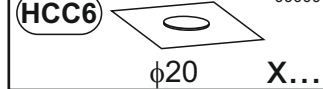
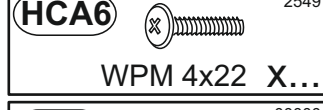
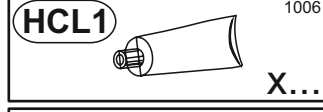
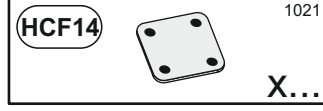
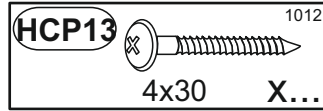
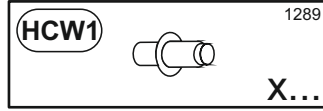
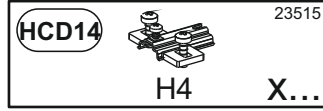
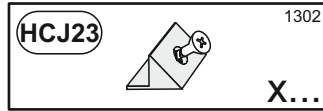
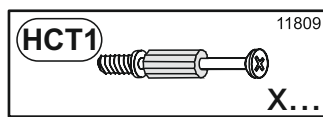
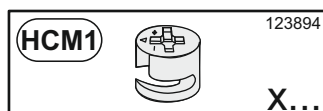
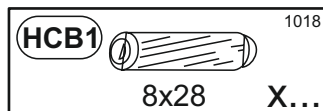
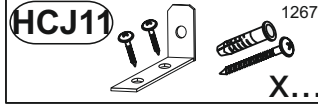
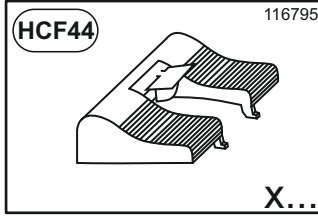
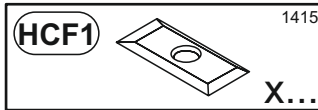
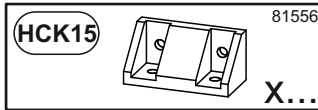
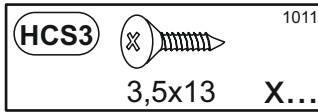
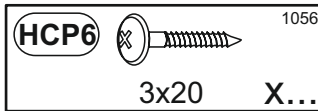
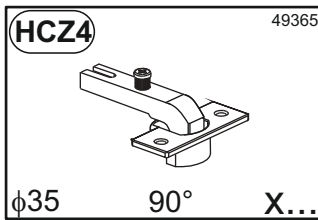
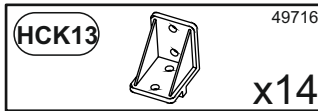
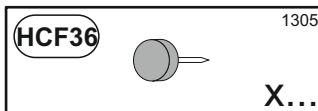

0049 52 339 529 010

service@imv-steinheim.de