

4900.994040_BAE007S40001

Bohrlochhöhen für Schraubhaken, Anschlussmaße und Abflusshöhen
drilling point for screw hooks, dimensions for mounting and drain

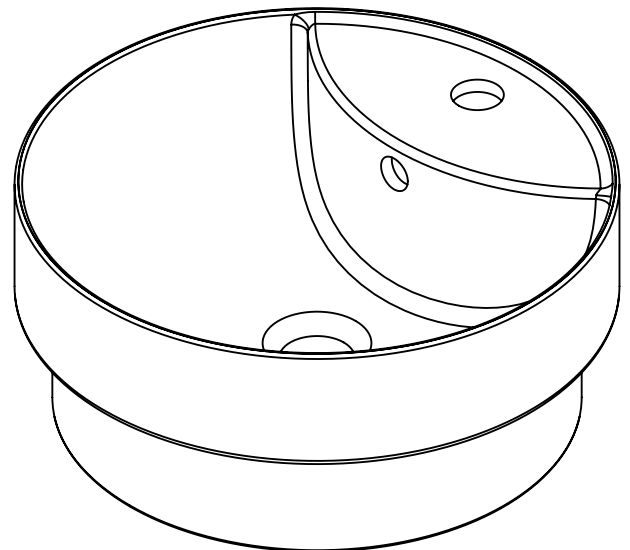

Bitte beachten Sie die Lage des Abflusses und der Wasseranschlüsse

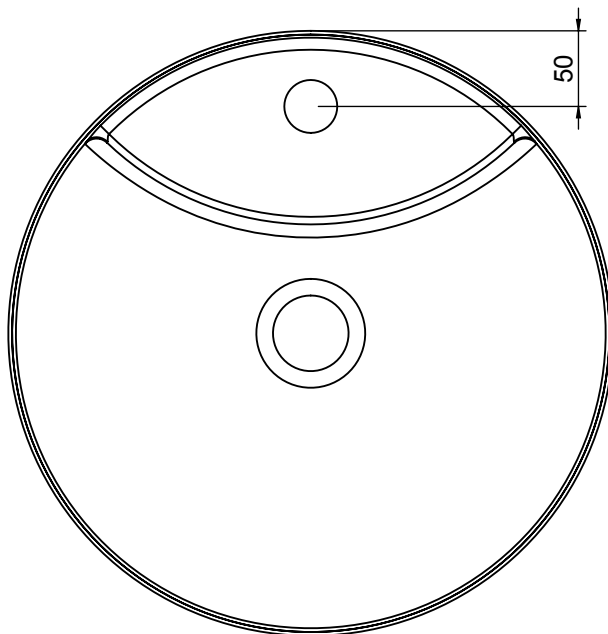
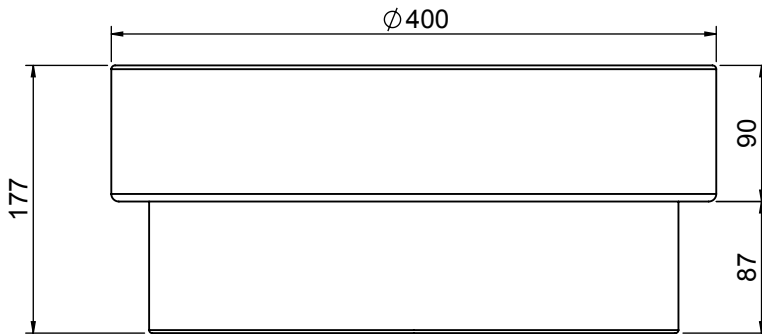

Der Elektroanschluss ist nur vom Fachmann nach DIN EN 60364 durchzuführen!



VORSICHT

Diese Hinweise dienen der Vermeidung von Sach- und Personenschäden
Bei Missachtung und daraus entstandenen Schäden übernehmen wir keine Haftung.
• Die Montage muß durch fachkundiges Personal erfolgen.
• Beachten Sie die beiliegenden Montageanleitungen.
• Montieren Sie bei Waschtischunterschrank die beiliegenden Zusatzsicherungswinkel

HINWEIS: Technische Änderungen und Irrtümer vorbehalten! Aktuellster Stand auf www.pelipal.com



Connection to power supply should be carried out only by a qualified technician and according to both IEC60364 and national regulations in force!



CAUTION

These instructions are intended to prevent personal injury or property damage.
We will not be held responsible in case of disregard.
• Assembly must be carried out by skilled personnel.
• Take notice of enclosed installation instructions.
• Assemble the included additional safety brackets for vanity base cabinets.

NOTICE: Technical changes and errors reserved! Latest status at www.pelipal.com

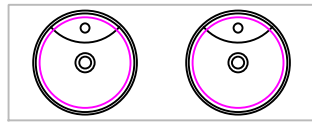
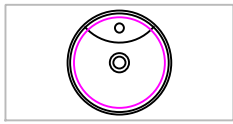
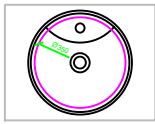

WT-Platte 1180/445

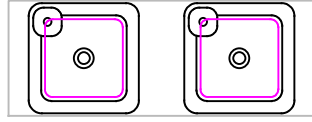
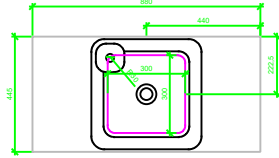
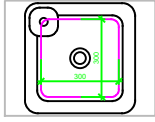

WT-Platte 1180/445

ArtNr für Platten mit Ausschnitt --> weiterzählen

- 4800.0258xx (Schiefer)
- 4800.0358xx (Oxid Hellgrau)
- 4800.4758xx (Riviera Eiche)

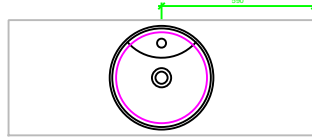
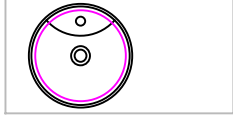

WT-Platte 1180/445

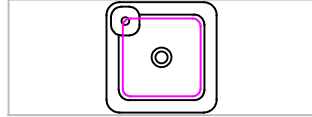
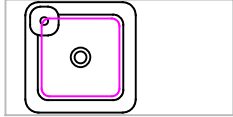

WT-Platte 1180/445

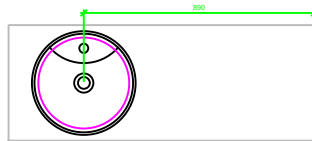
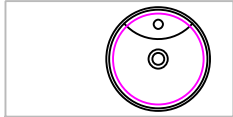

WT-Platte 1180/445

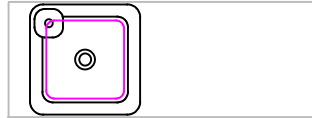
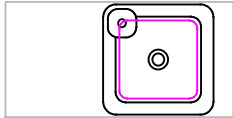

WT-Platte 1180/445

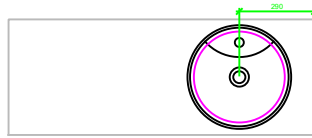

WT-Platte 1180/445

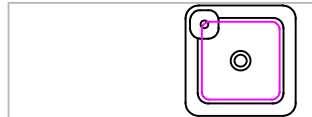

WT-Platte 1180/445

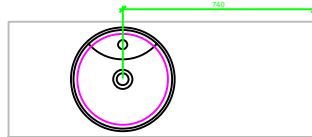

WT-Platte 1180/445

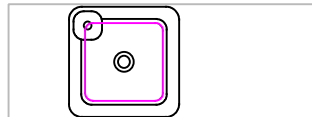

WT-Platte 1180/445

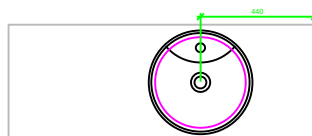

WT-Platte 1180/445

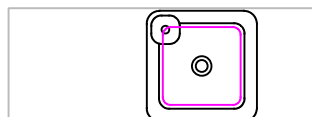

WT-Platte 1180/445

4035.151101_WT-Platte_Aufsatz-WT

Bohrlochhöhen für Schraubhaken, Anschlussmaße und Abflusshöhen
drilling point for screw hooks, dimensions for mounting and drain

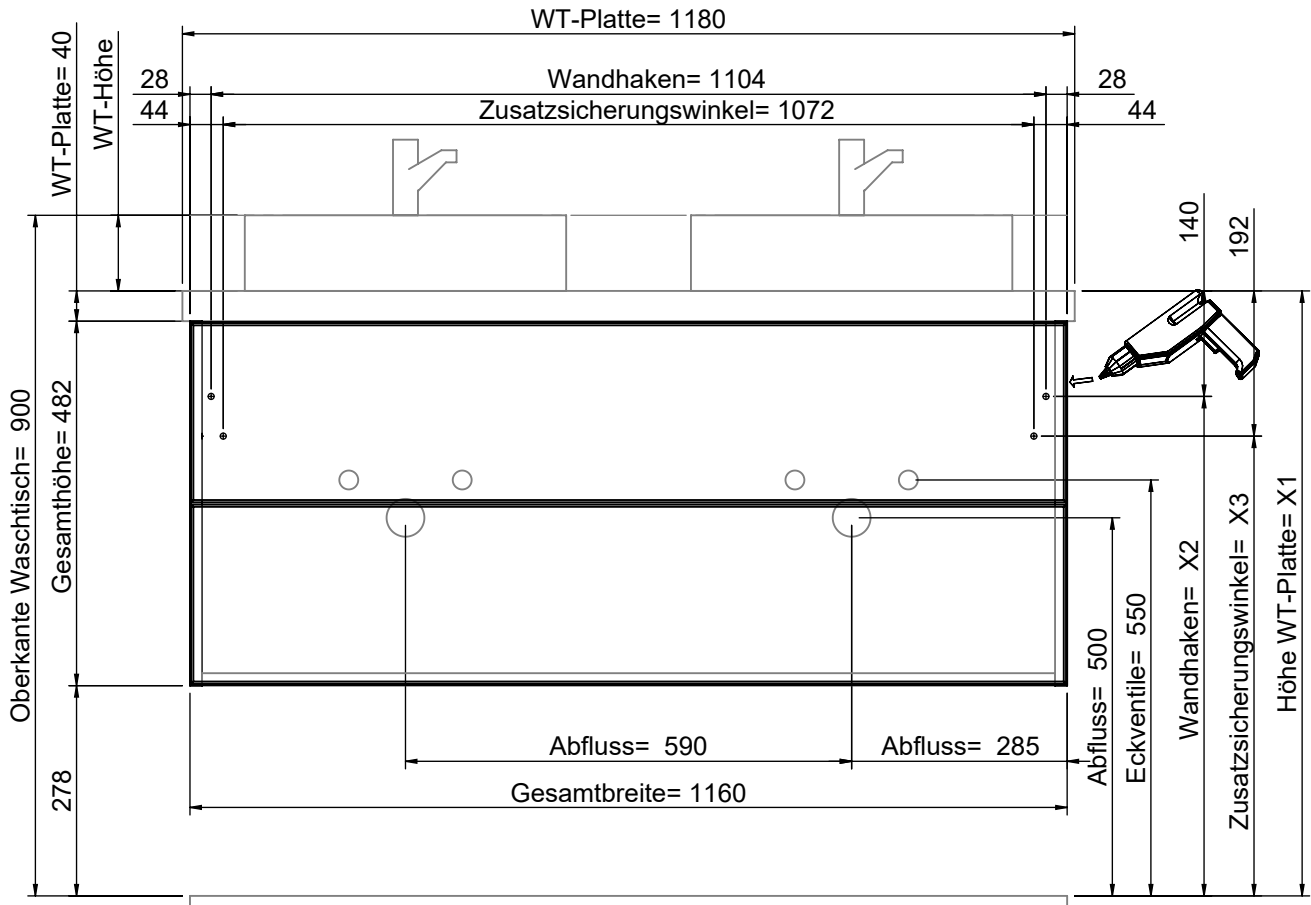

X1 = 900 mm - Höhe Waschtisch
X2 = 900 mm - Höhe Waschtisch - 140 mm
X3 = 900 mm - Höhe Waschtisch - 192 mm

Bitte beachten Sie die Lage des Abflusses und der Wasseranschlüsse



Der Elektroanschluss ist nur vom Fachmann nach DIN EN 60364 durchzuführen!



VORSICHT

Diese Hinweise dienen der Vermeidung von Sach- und Personenschäden. Bei Missachtung und daraus entstandenen Schäden übernehmen wir keine Haftung.

- Die Montage muß durch fachkundiges Personal erfolgen.
- Beachten Sie die beiliegenden Montageanleitungen.
- Montieren Sie bei Waschtischunterschrank die beiliegenden Zusatzsicherungswinkel

HINWEIS: Technische Änderungen und Irrtümer vorbehalten! Aktuellster Stand auf www.pelipal.com



Connection to power supply should be carried out only by a qualified technician and according to both IEC60364 and national regulations in force!



CAUTION

These instructions are intended to prevent personal injury or property damage.

We will not be held responsible in case of disregard.

- Assembly must be carried out by skilled personnel.
- Take notice of enclosed installation instructions.
- Assemble the included additional safety brackets for vanity base cabinets.

NOTICE: Technical changes and errors reserved! Latest status at www.pelipal.com