

Alpi 74195

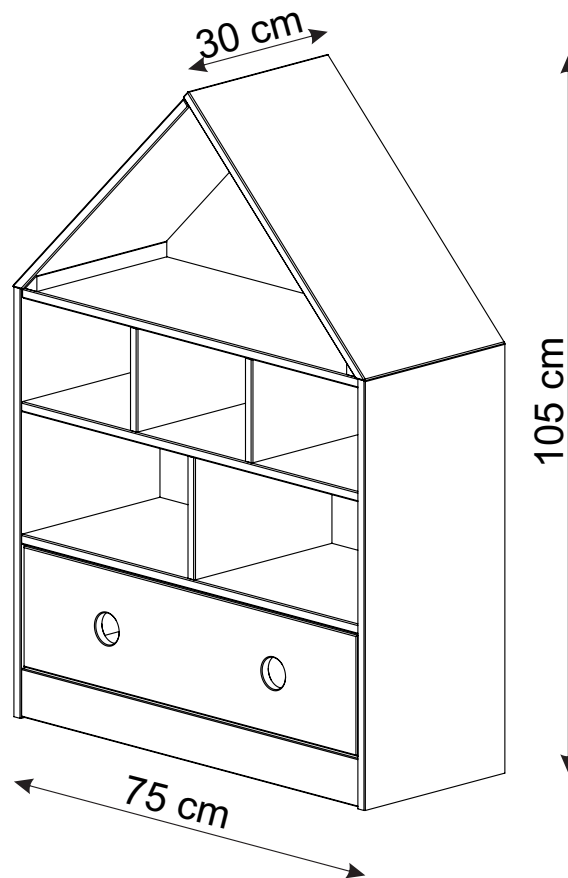

(D) Montageanleitung
74195

(FR) Notice de montage
74195

(NL) Handleiding voor de montage
74195

(CZ) Montážní návod
74195

(HU) Szerelési útmutató
74195

(TR) Montaj talimatı
74195

(GB) Assembly instructions
74195

(IT) Istruzioni di montaggio
74195

(PL) Instrukcja montażu
74195

(SK) Návod na montáž
74195

(RO) Instrucțiuni de montaj
74195



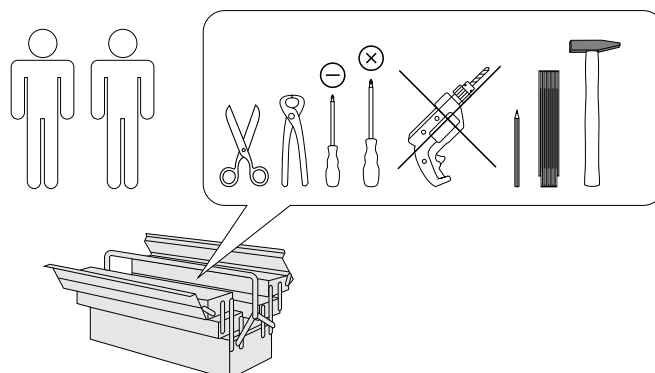



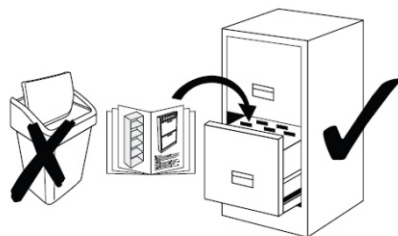
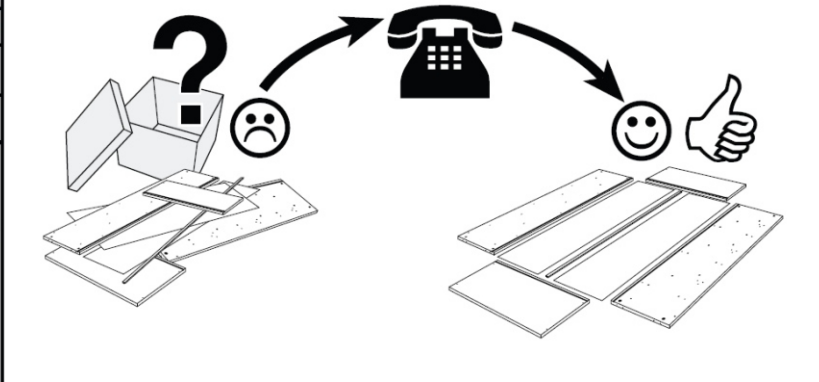

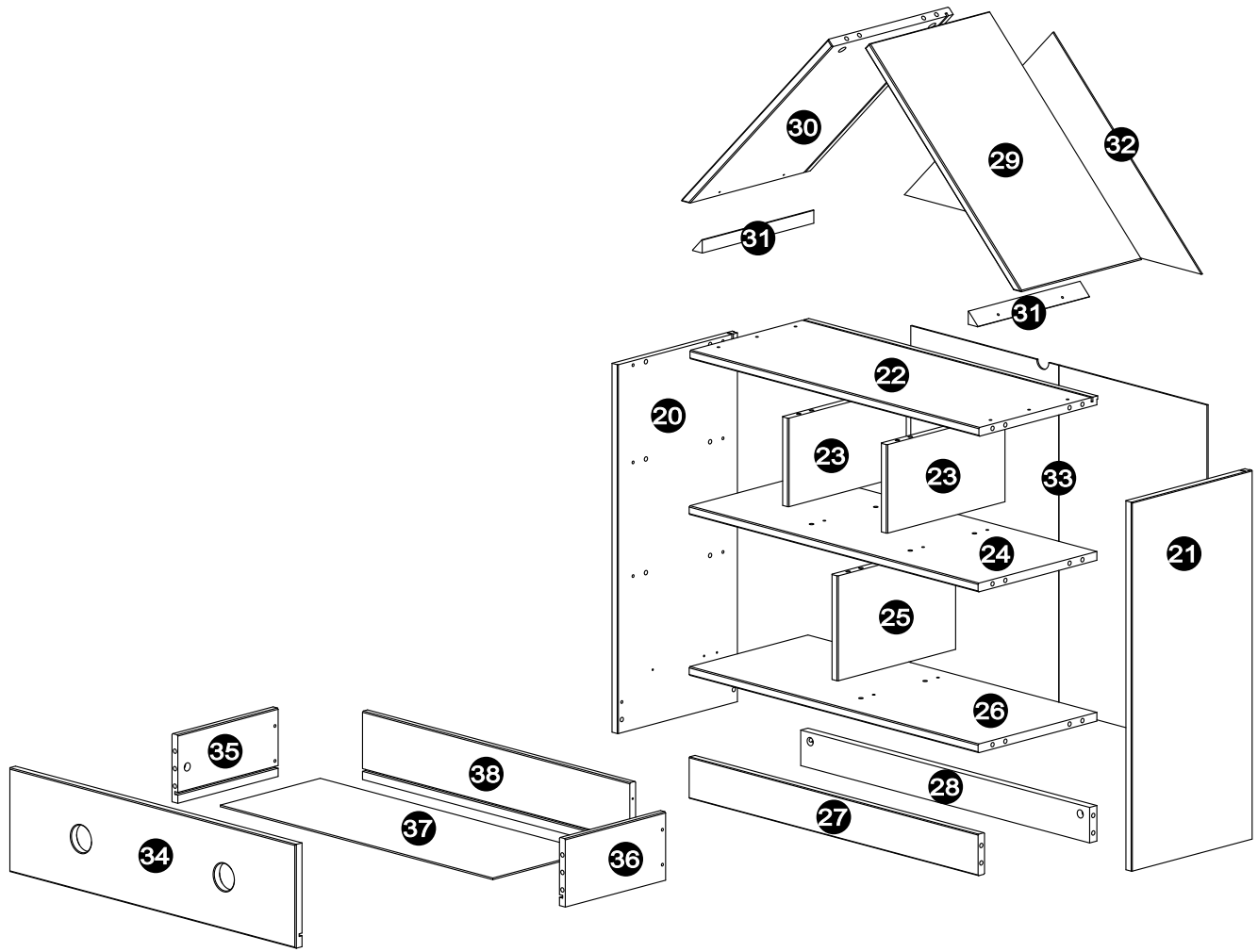
(RU) Инструкция по монтажу
74195

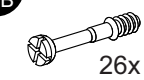

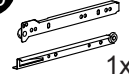
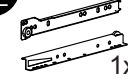
0
10
20
30
40
50
60
70
80
90
100
110
120
130
140
150
160
170
180
190
200

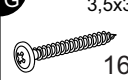
Service • Assistenza • Dienstverlening • Serwis Servis • Szerviz • Сервисная служба	
Name • Nom • Nome • Naam • Nazwa • Jméno • Názov • Név • Denumire • Ísim • Название	
Nr. • No. • N° • Номер • Č • Sz	
Typ • Type • Tip • Típus • Tipo • Тип	
	
	

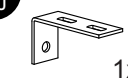
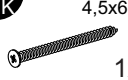

- | | | | | | | | | | |
|---|---|---|---|---|--|--|---|--|--|
| A 8,0x30
 34x | B  26x | C  26x | D  1x | E  1x | F 3,5x14
 12x | G 3,5x30
 16x | H 4,0x20
 4x | I  26x | |
| J  1x | K 4,5x60
 1x | L 6,0x20
 4x | | | | | | | |

1

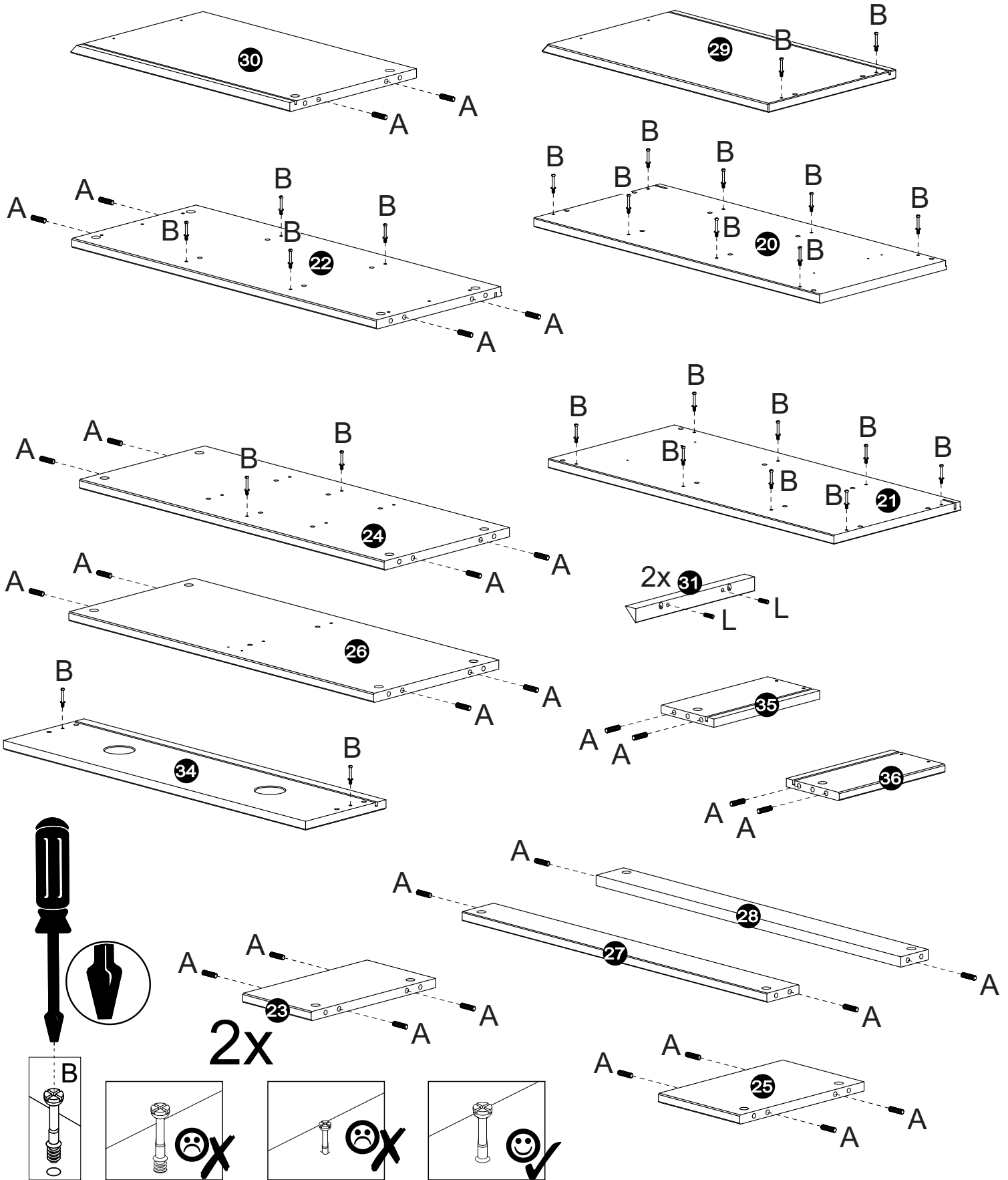
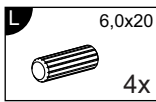
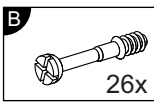
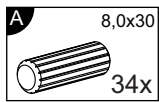

2x

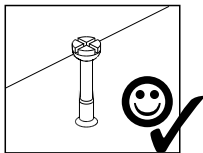
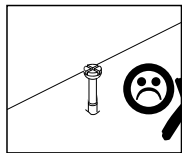
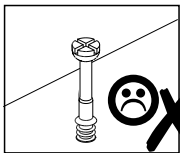
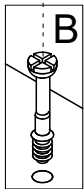

4

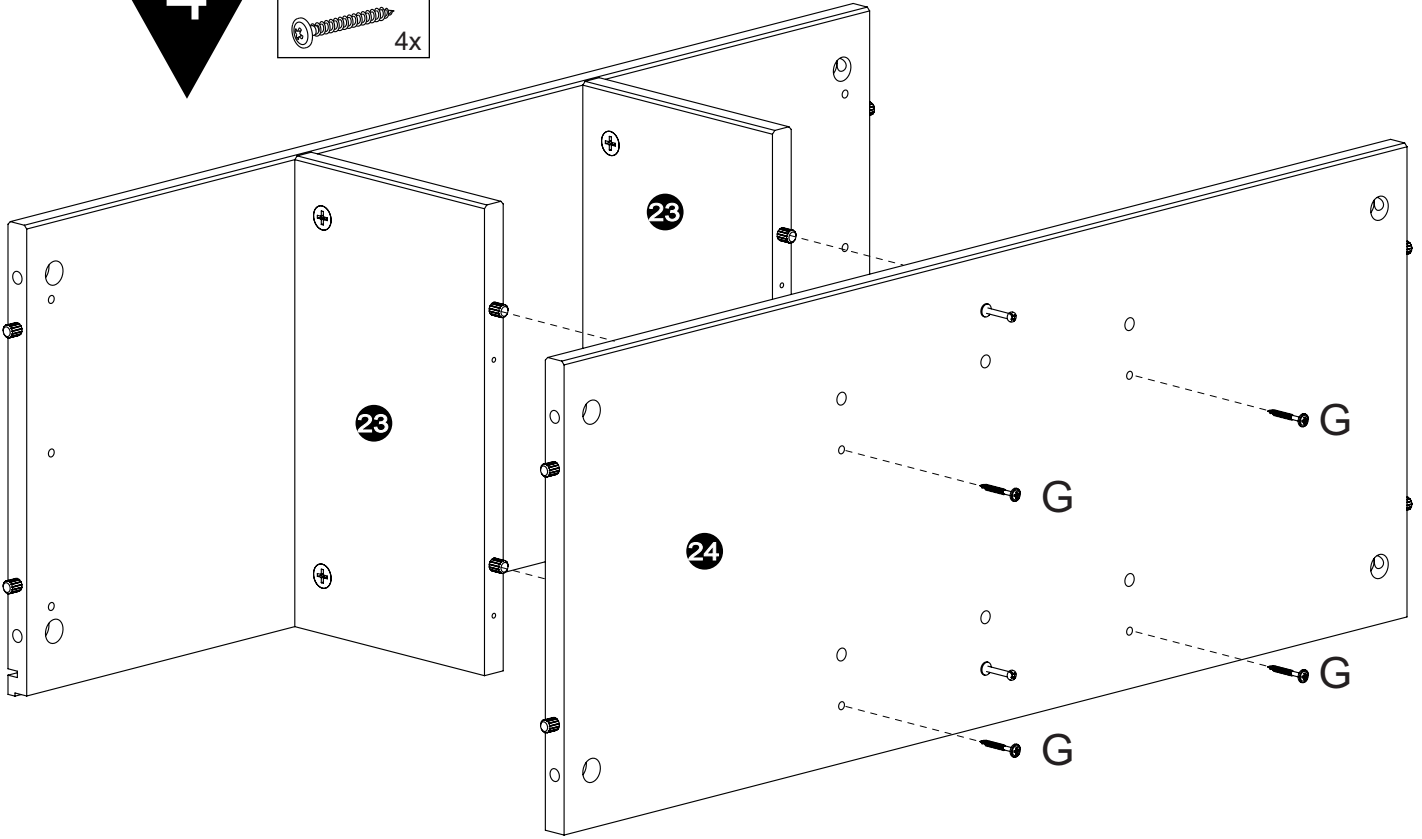
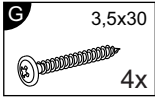

5

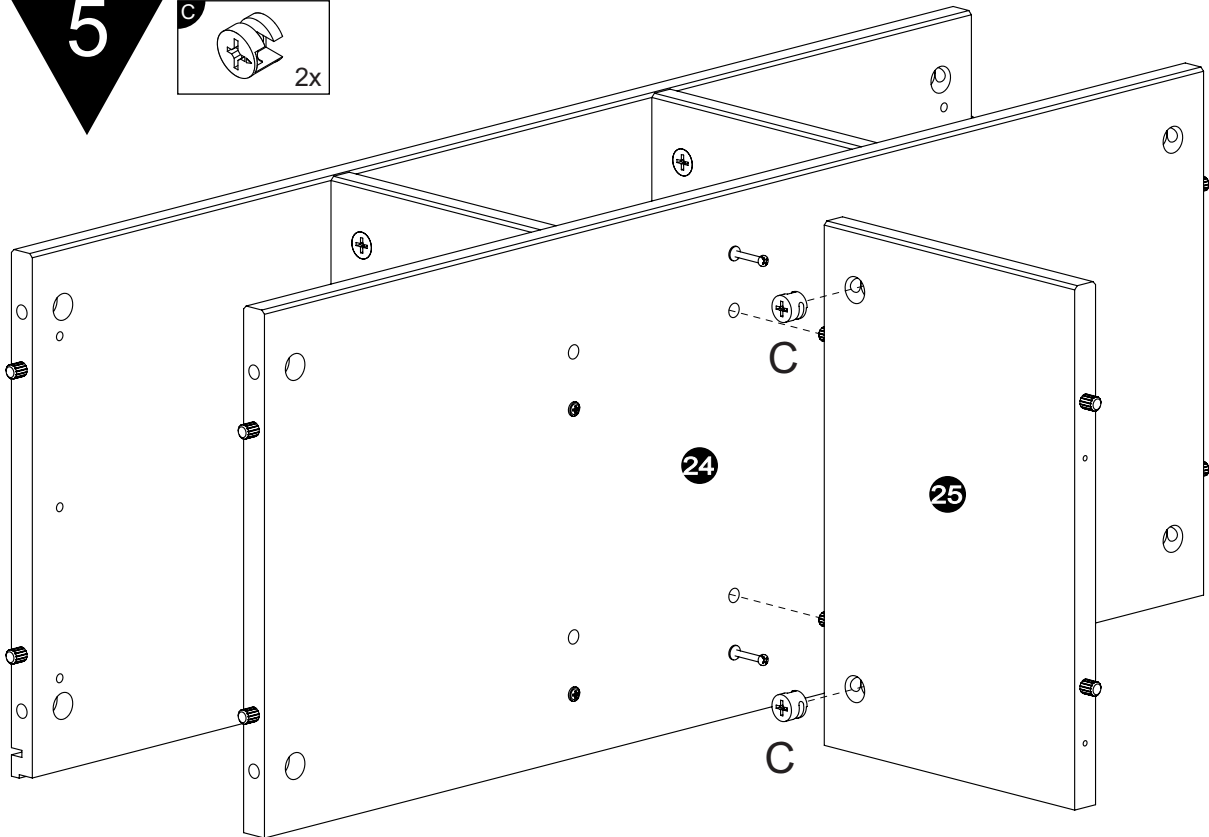
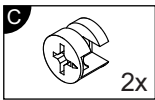

6

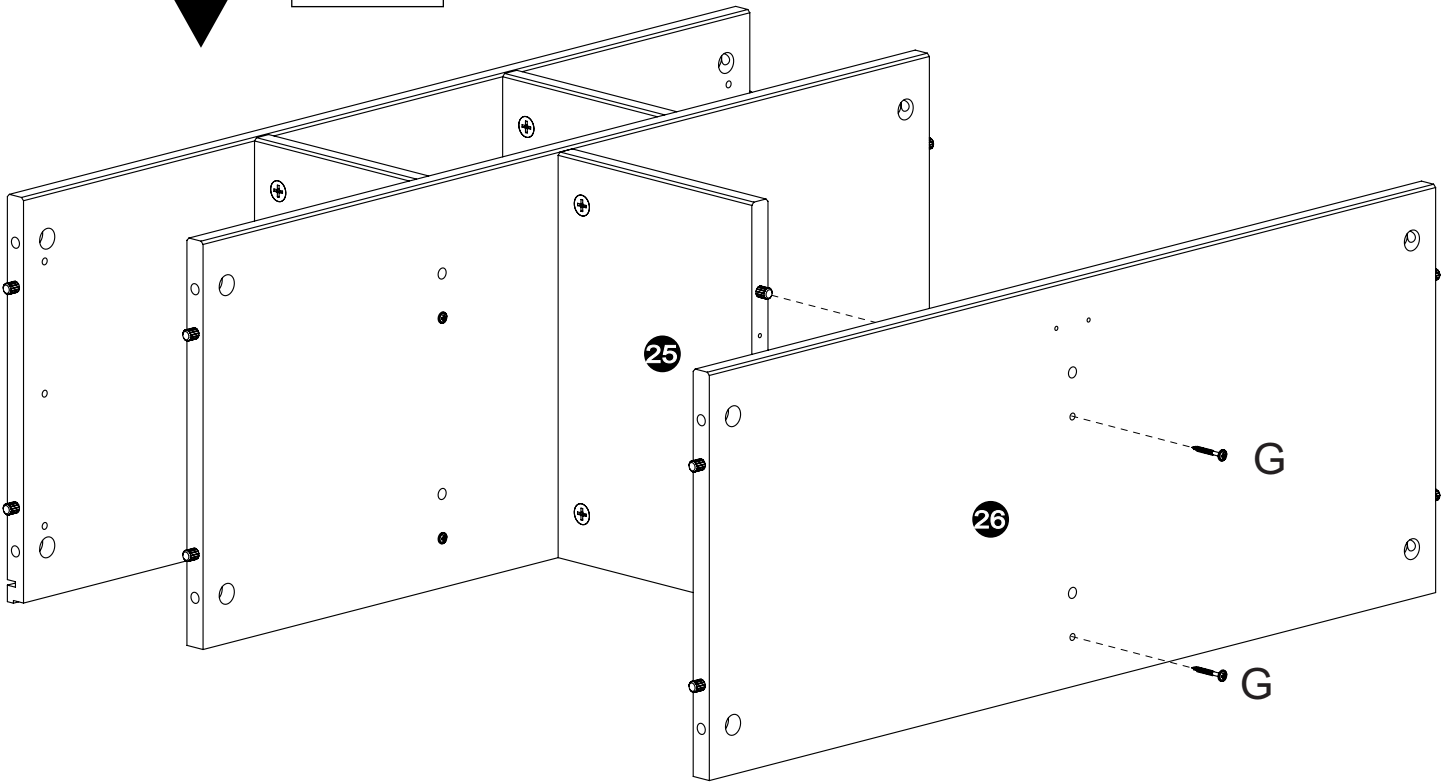
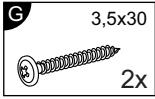

7

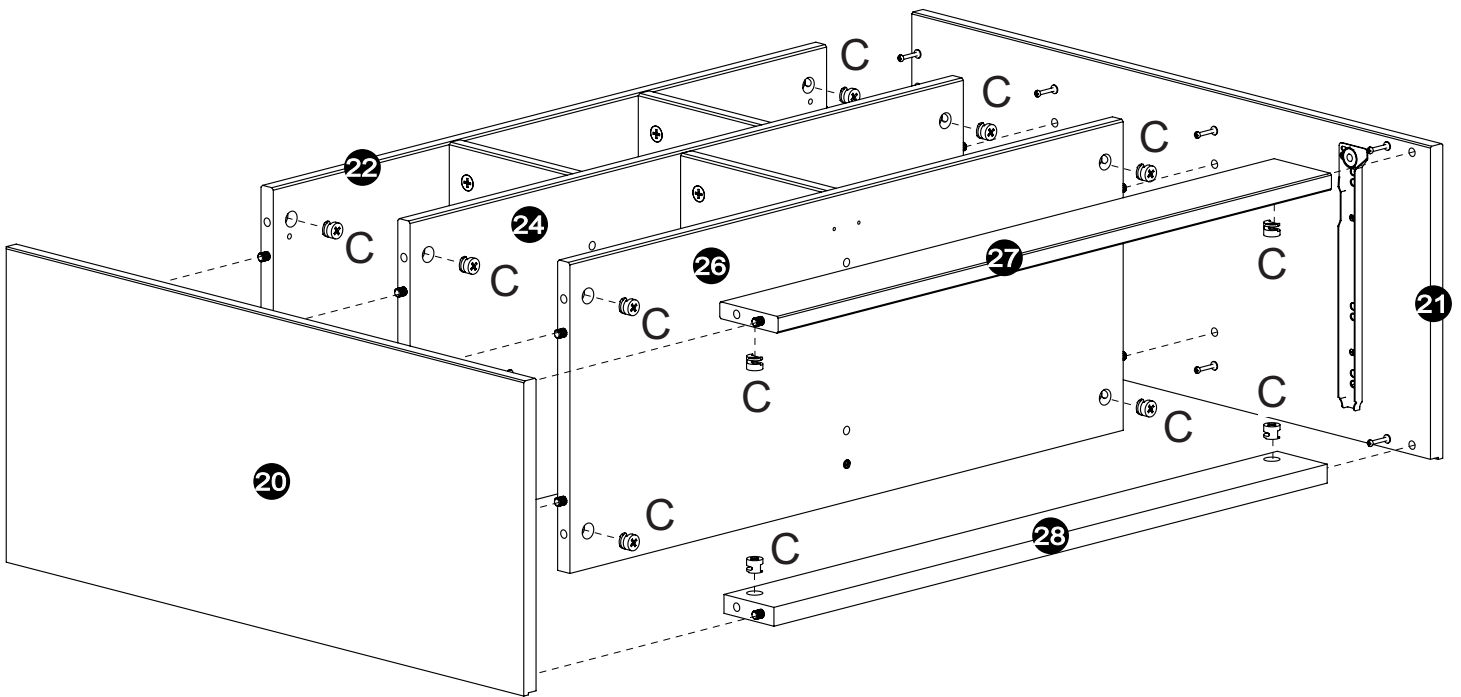
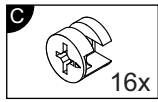

8

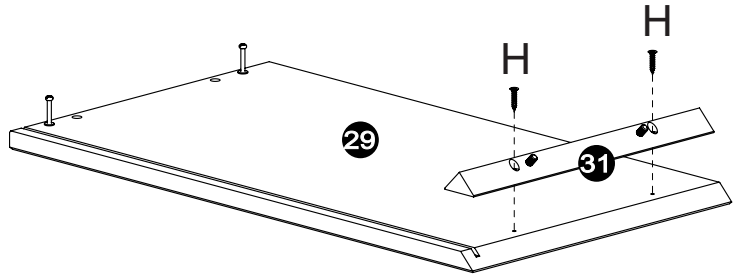
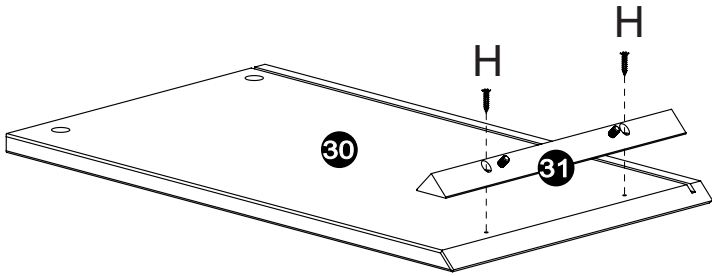
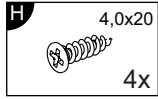

9

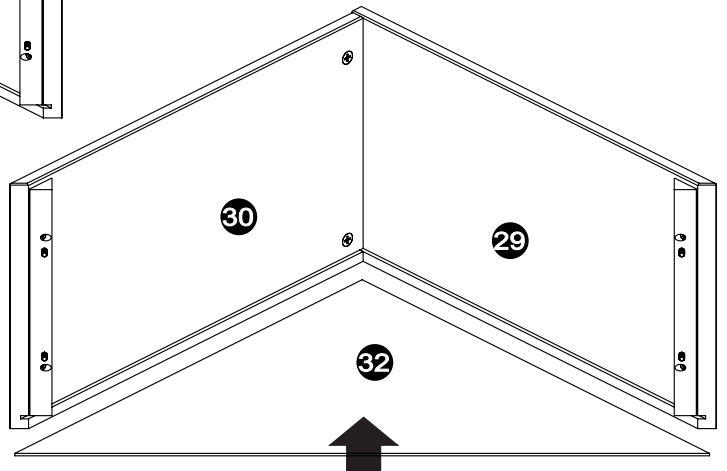
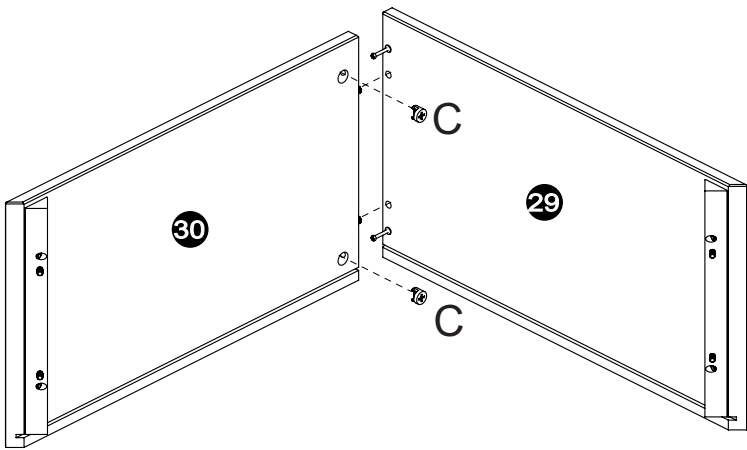
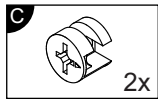

10

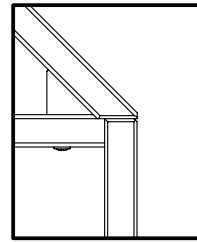
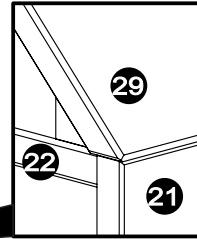
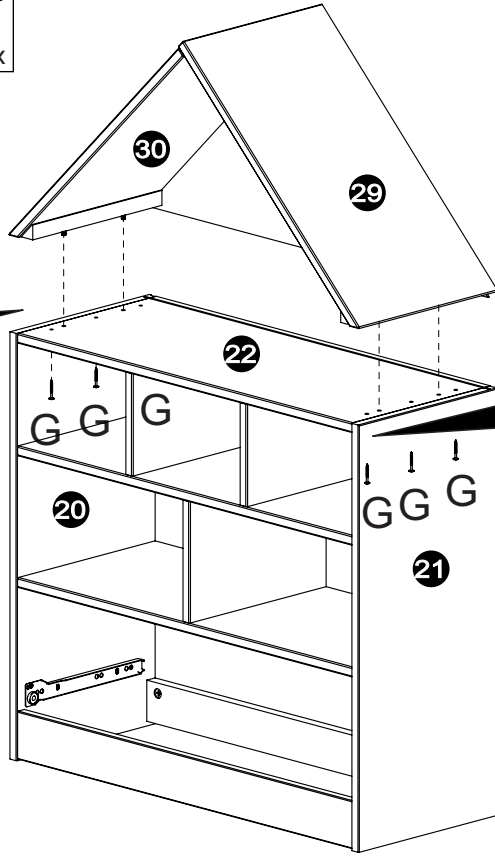
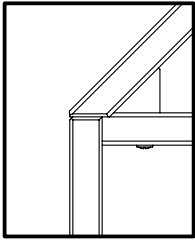
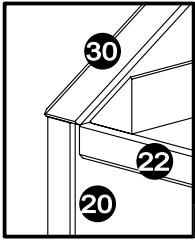
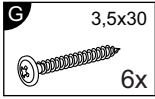

11

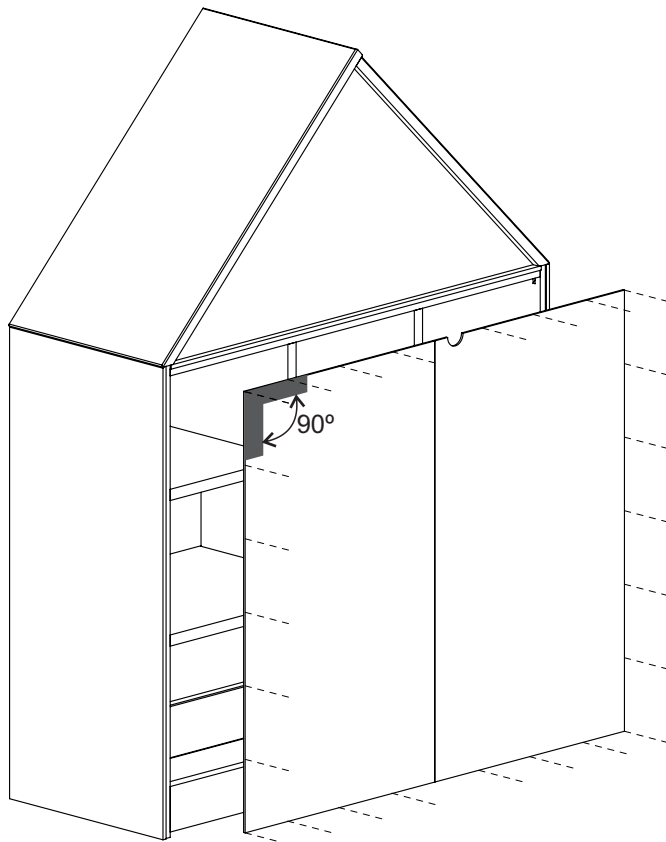
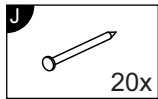

12

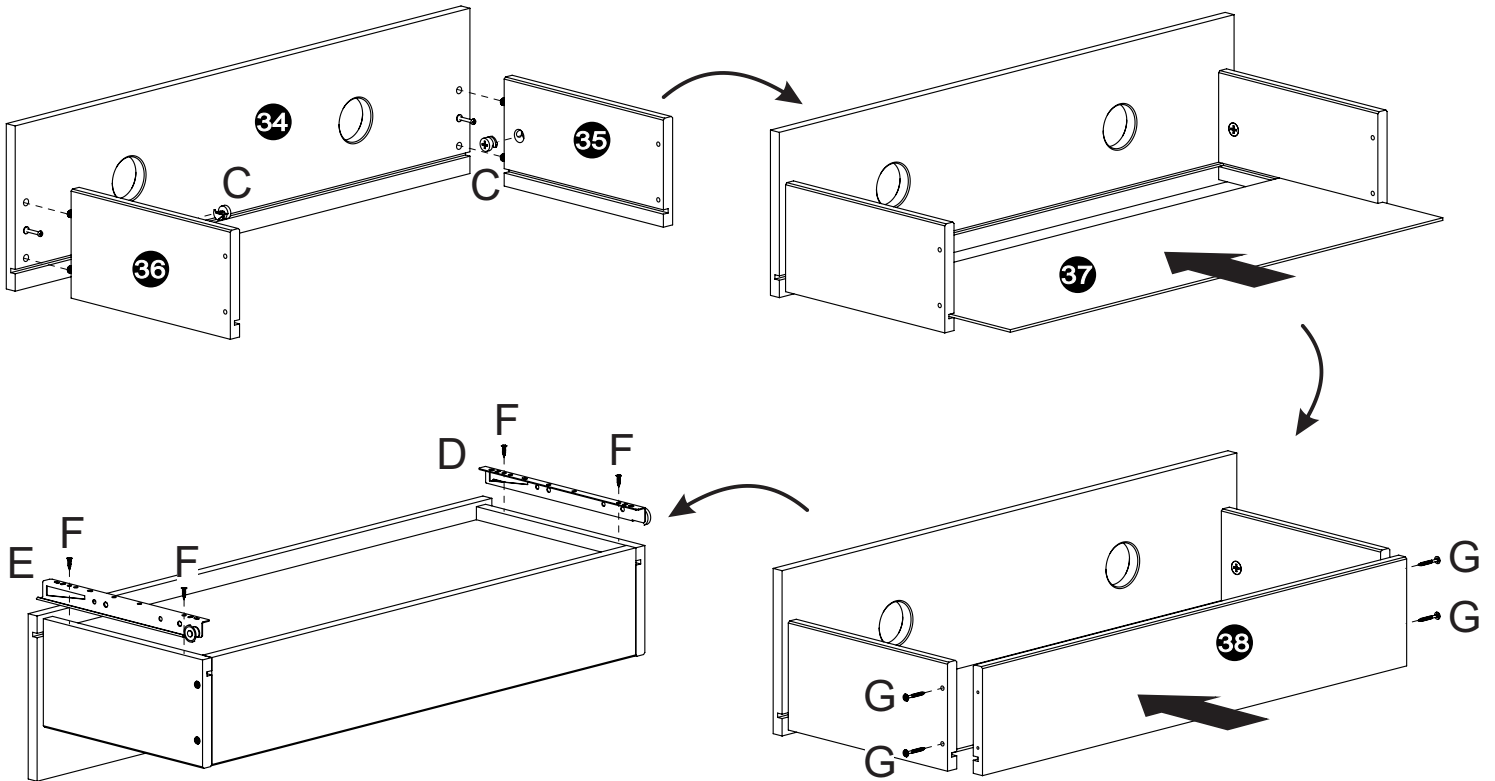
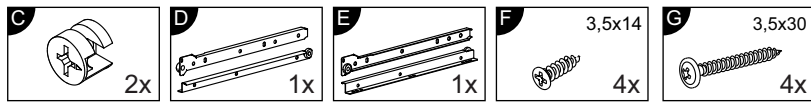

13

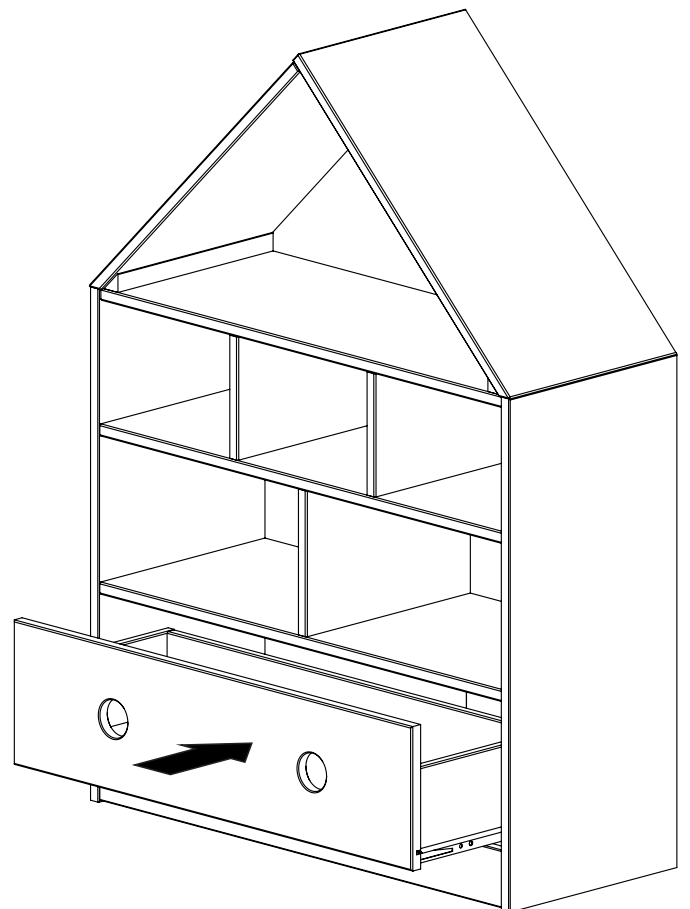
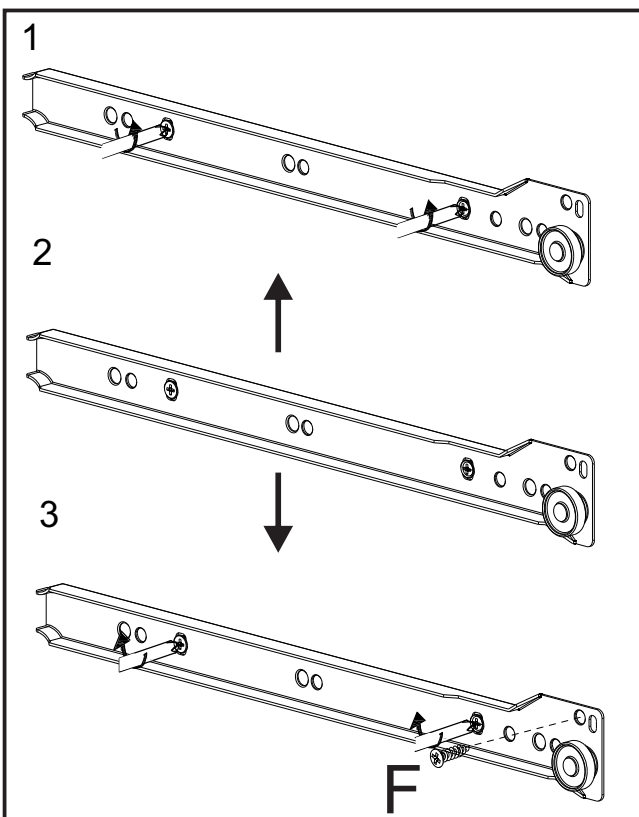
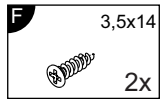

14

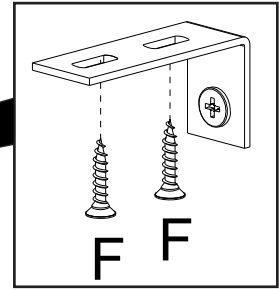
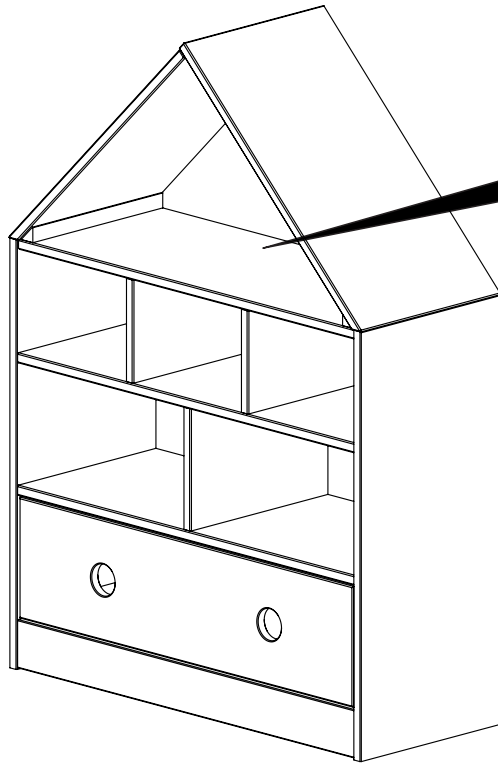
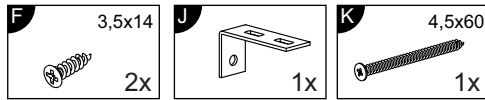

⚠ Achtung • Attention • Attenzione Opgelet • Uwaga • Pozor • Figyelem Atenție • Dikkat • Внимание ⚠	
(D)	Wandbefestigung dient als Kippschutz – unbedingt anbringen! Bei einigen Wandtypen kann ein Spezialdübel erforderlich sein!
(GB)	The wall fastening serves to prevent tipping – be absolutely sure to mount it! For certain wall types, a special wall plug may be necessary!
(FR)	La fixation murale sert de protection contre le basculement – à installer impérativement ! Pour certains types de murs il faut des chevilles spéciales !
(IT)	Il fissaggio alla parete serve da protezione anti-ribaltamento – attaccarla assolutamente! Per alcune strutture di parete può essere necessario un tassello speciale!
(NL)	Bevestiging aan de muur dient als kantelbescherming – zeker en vast bevestigen! Bij enkele muurtypes is een speciale plug misschien vereist!
(PL)	Mocowanie do ściany jest jednocześnie zabezpieczeniem przed przewróceniem – koniecznie zamontować! Do niektórych rodzajów ścian koniecznie zastosować specjalne kołki mocujące.
(CZ)	Montáž na stěnu slouží jako ochrana proti převrnutí – bezpodmienečně umístěte! U některých typů stěn může být zapotřebí speciální hmoždinka!
(SK)	Upevnenie na stenu slúži ako ochrana proti prevráteniu – bezpodmienečne použite! Pre niektoré druhy stien môže byť potrebná špeciálna hmoždinka!
(HU)	A termék a falhoz kel rögzíténi, különben az felborulhat! Egyes fal típusoknál speciális tiplit kell használni!
(RO)	Sistemul de fixare la perete servește ca protecție la răsturnare – de montat obligatoriu! Pentru unele tipuri de pereți este posibil să fie necesar un diblu special!
(TR)	Duvardaki sabitleme, devrilmeye karşı bir emniyet tedbiridir ve mutlaka monte edilmelidir! Bazı duvar tiplerinde bunun için özel bir dübel gerekli olabilir!
(RU)	Обязательно установите крепление на стене во избежание опрокидывания! Для некоторых типов стен может потребоваться специальный дюбель!

