

OXFORD 2

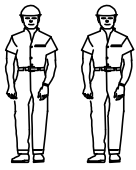

15min

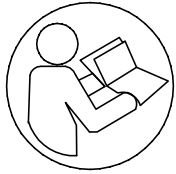

(D) Montageanleitung

(NL) Handleiding voor de montage

(TR) Montaj talimatı

(F) Notice de montage

(CZ) Montážní návod

(GB) Assembly instructions

(HU) Szerelési útmutató

(PL) Instrukcja montażu

(RU) Инструкция по монтажу

(IT) Istruzioni di montaggio

(SK) Návod na montáž

(RO) Instrucțiuni de montaj

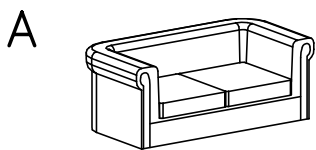
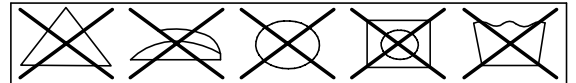
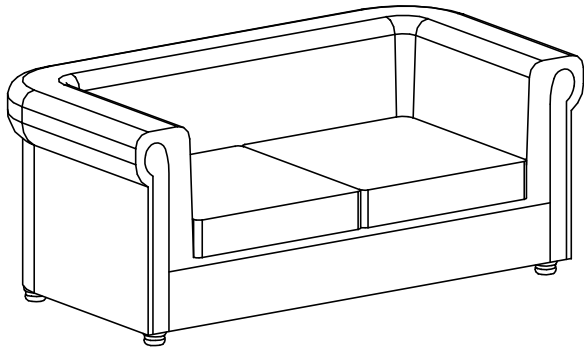

x1

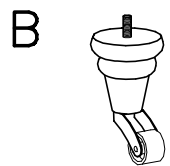

x2

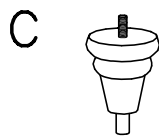

x2

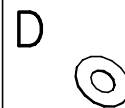

x4

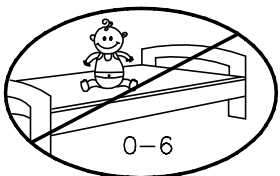

0-6

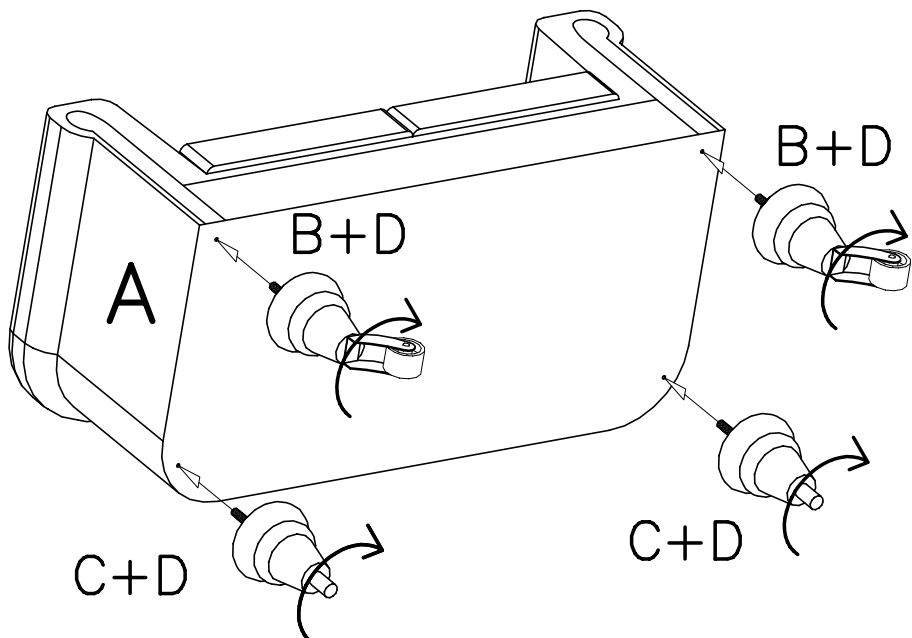
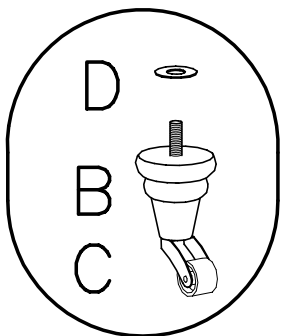
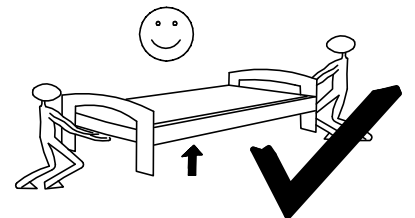
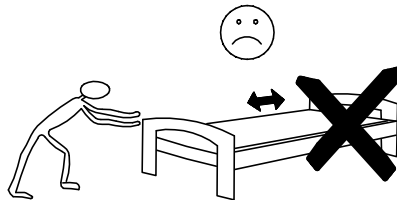
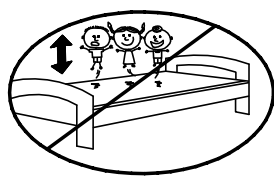

Service • Assistenza • Dienstverlening • Serwis •
 Servis • Szerviz • Сервисная служба

| | |
|---|--------|
| Name • Nom • Nome • Naam • Nazwa • Jméno • Název • Név • Denimire • Isim • Название | OXFORD |
| Nr • No. • N° • Номер • Č • Sz | |
| Type • Tipo • Tipus • Typ • Тип • Тип | 2 |

