

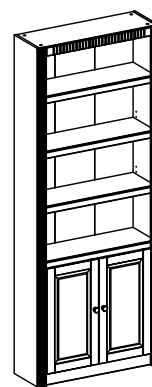

Billie 7791 / 7848

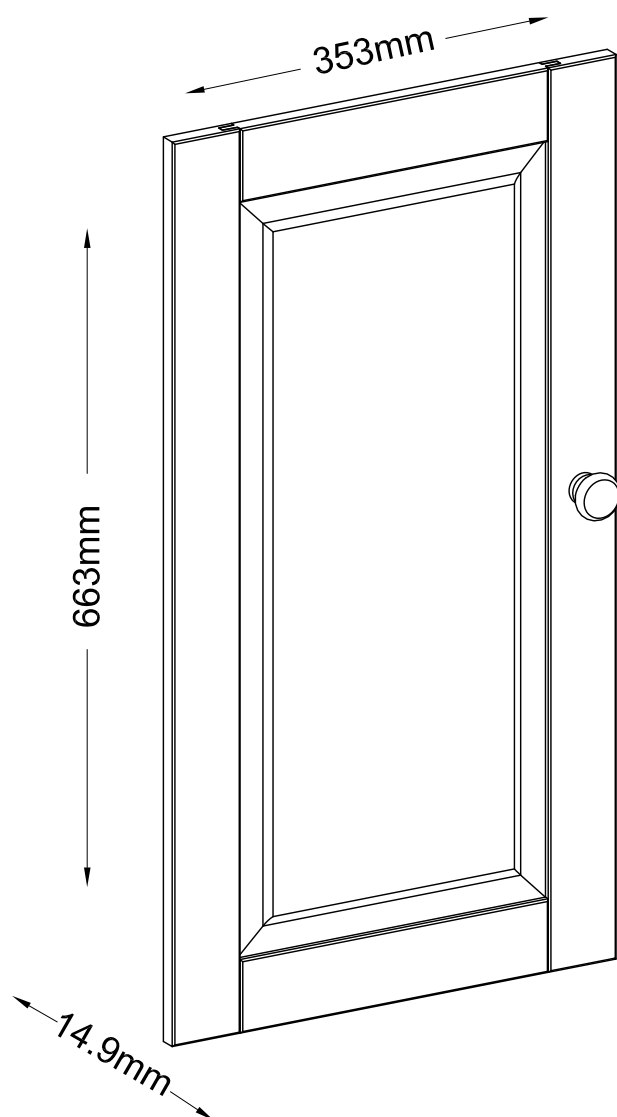

- | | |
|---|-------------------------------------|
| (D) Montageanleitung | (GB) Assembly instructions |
| (FR) Notice de montage | (IT) Istruzioni di montaggio |
| (NL) Handleiding voor de montage | (PL) Instrukcja montażu |
| (CZ) Montážní návod | (SK) Návod na montáž |
| (HU) Szerelési útmutató | (RO) Instrucțiuni de montaj |
| (TR) Montaj talimatı | (RU) ИНСТРУКЦИЯ ПО МОНТАЖУ |

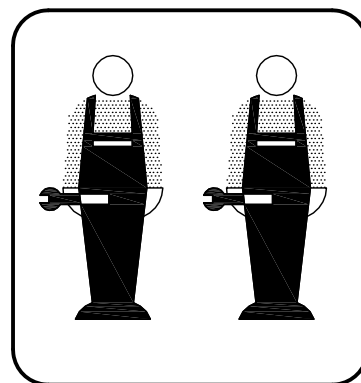
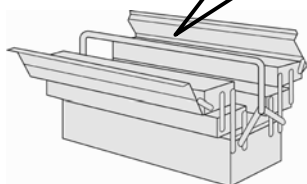
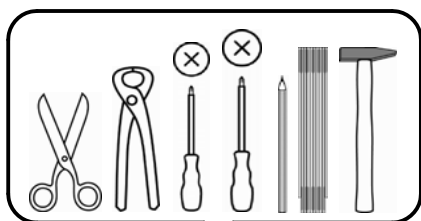

Service • Assistenza • Dienstverlening • Serwis Servis • Szerviz • Сервисная служба

Name • Nom • Nome • Naam • Nazwa • Jméno • Názov • Név • Denumire • Ísim • Название	
Nr. • No. • N° • Номер • Č • Sz	
Typ • Type • Тип • Típus • Tipo • Тип	
	

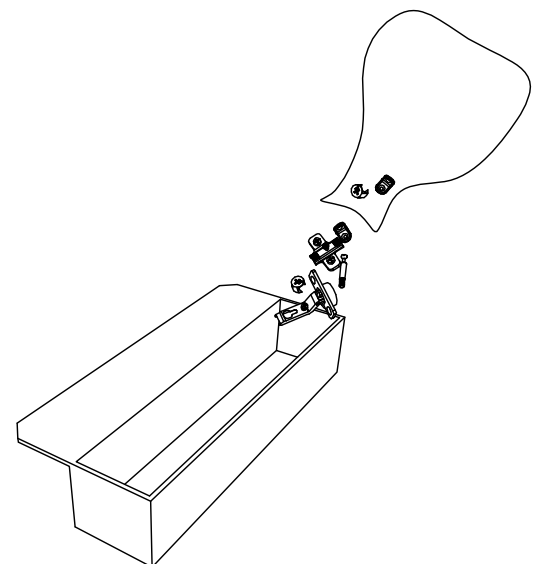
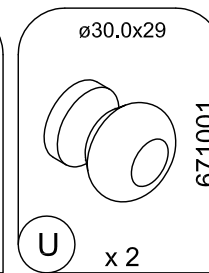
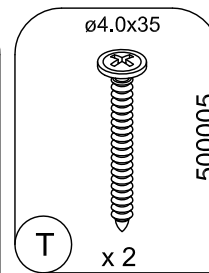
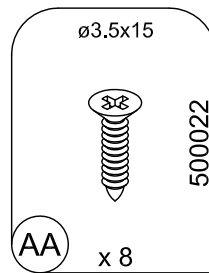
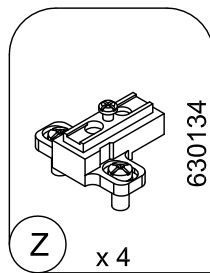
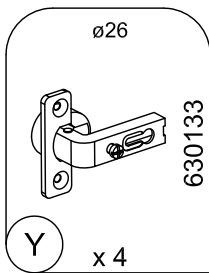
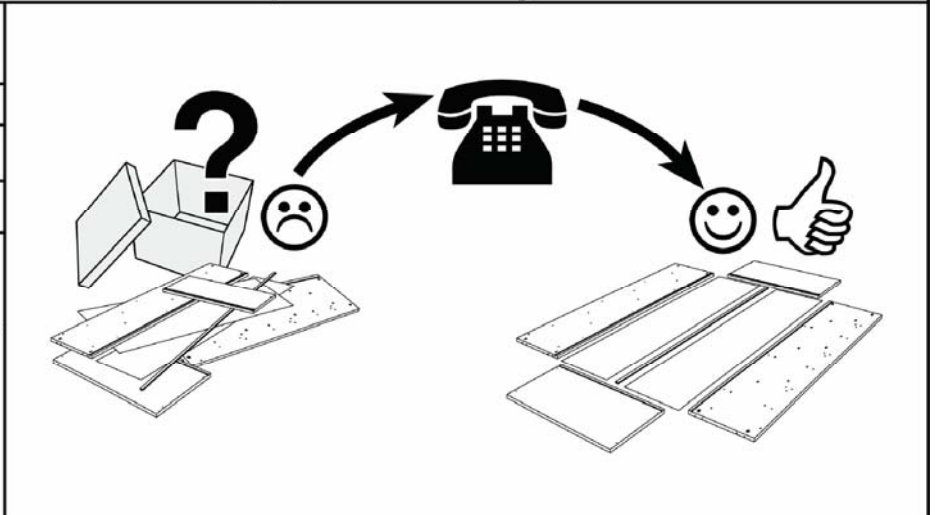
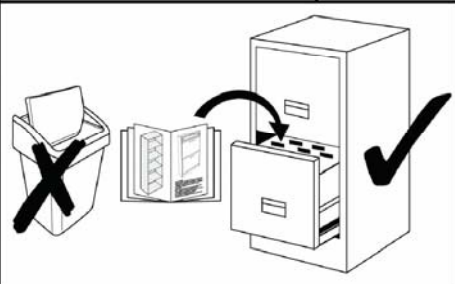

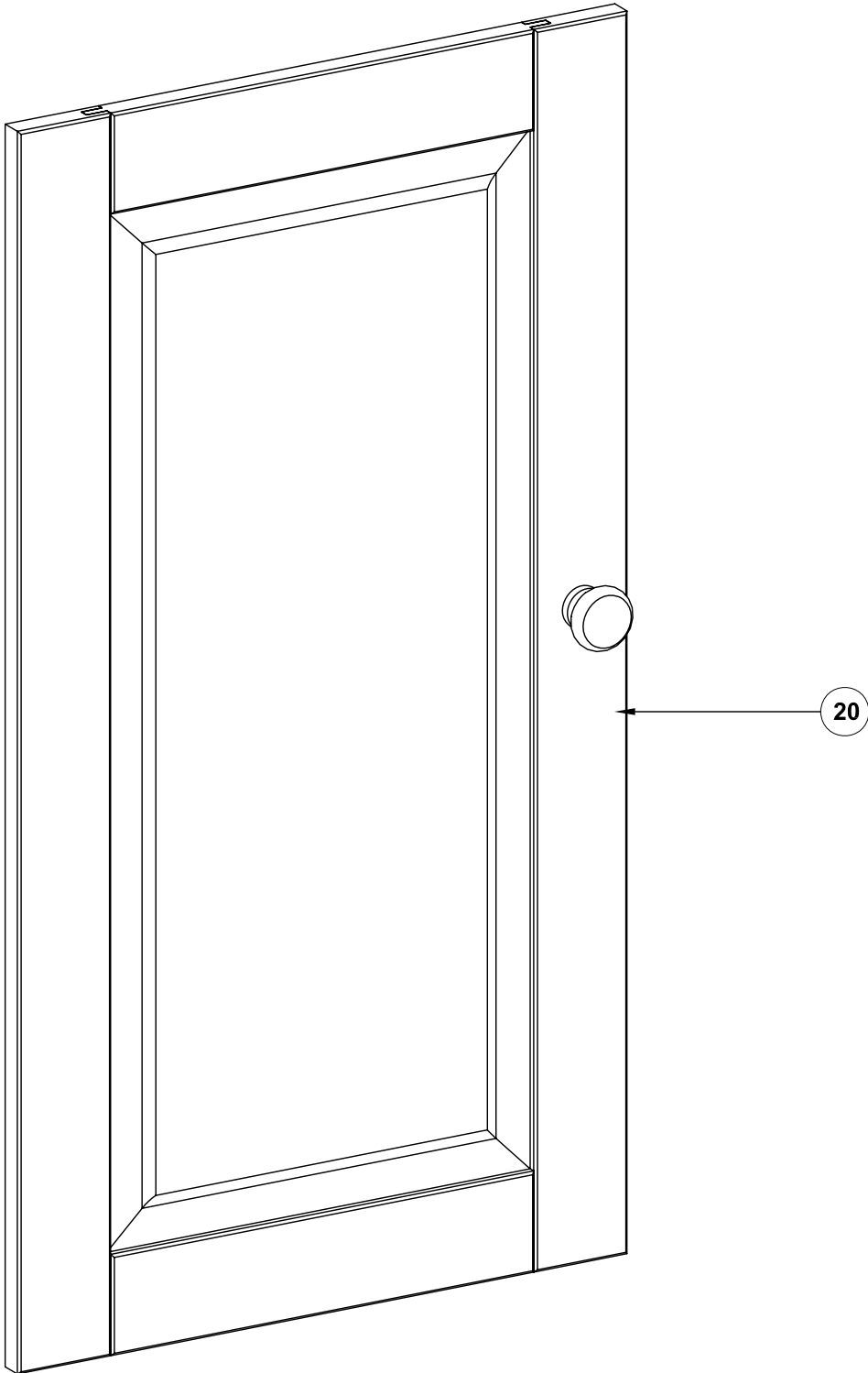

01

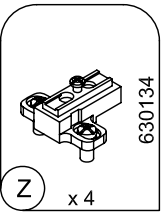
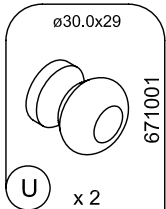
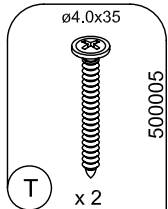
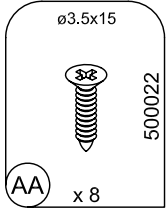
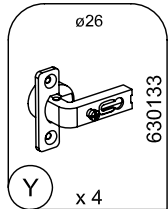
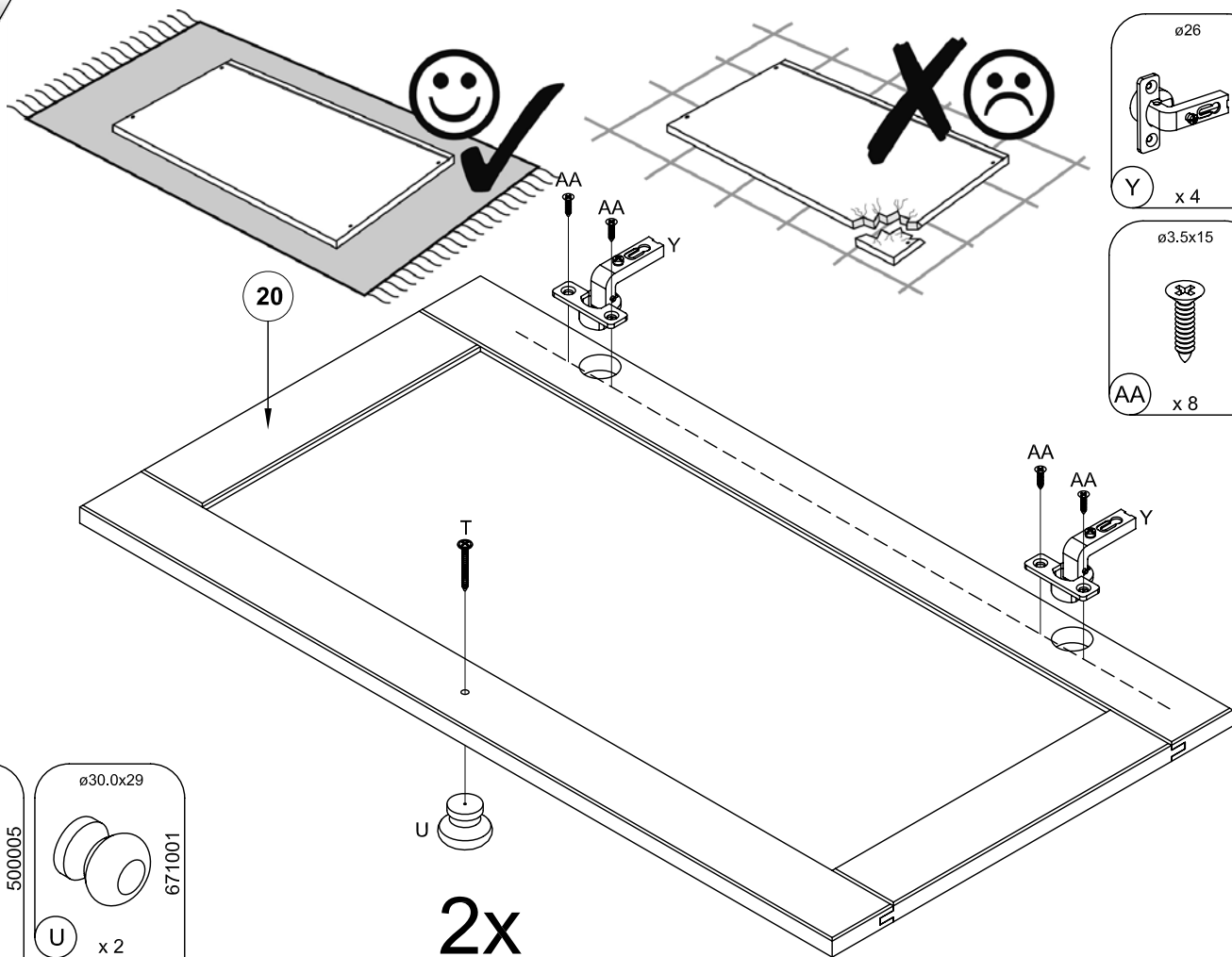

02

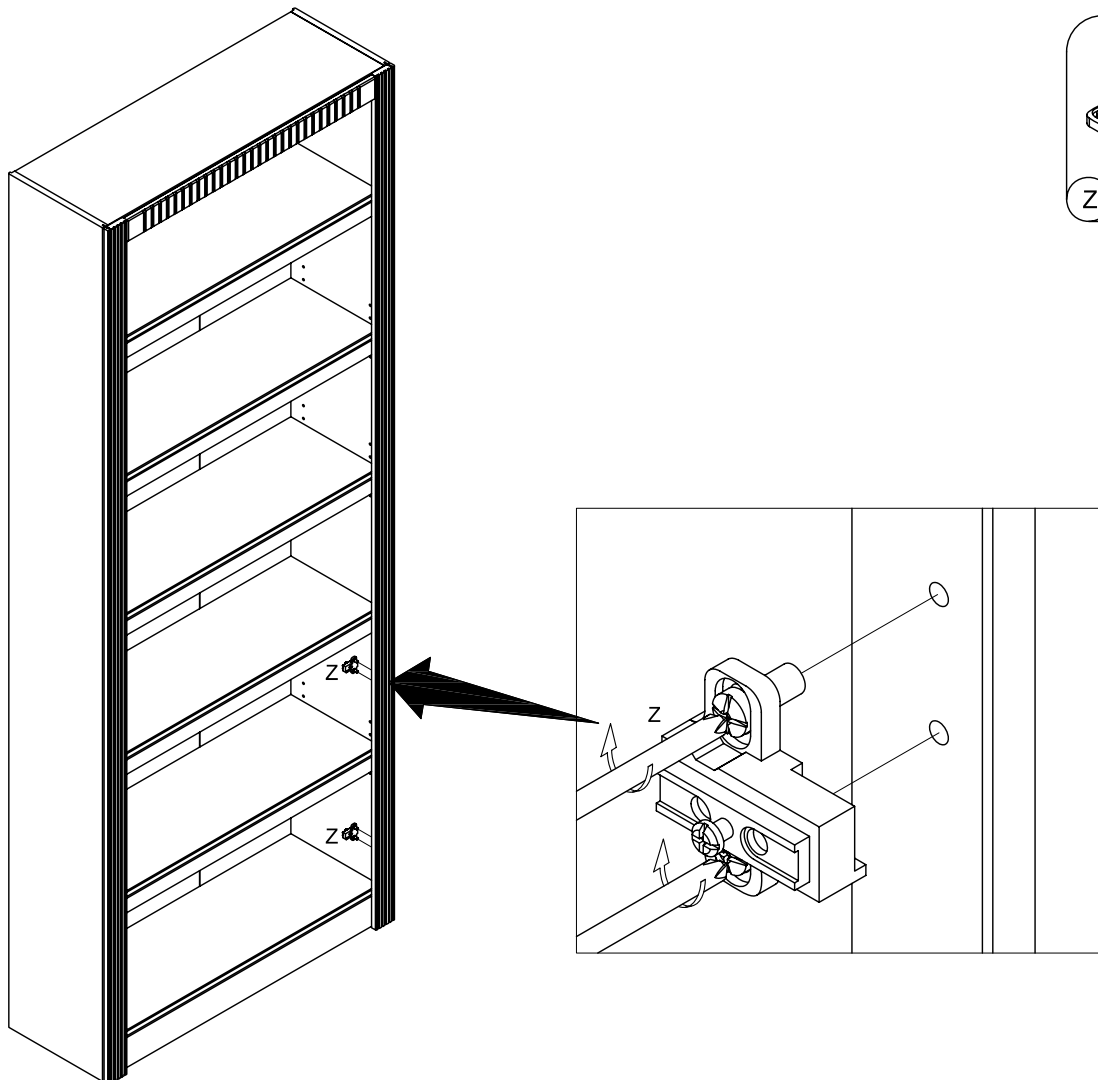

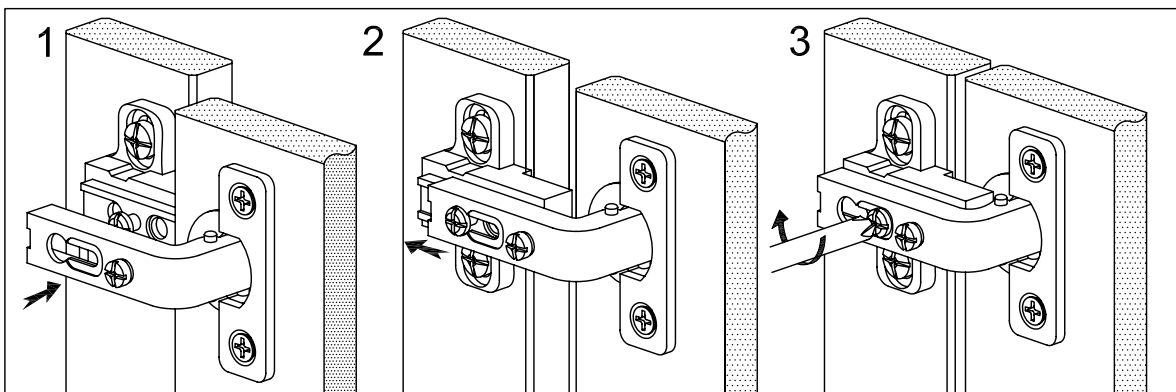
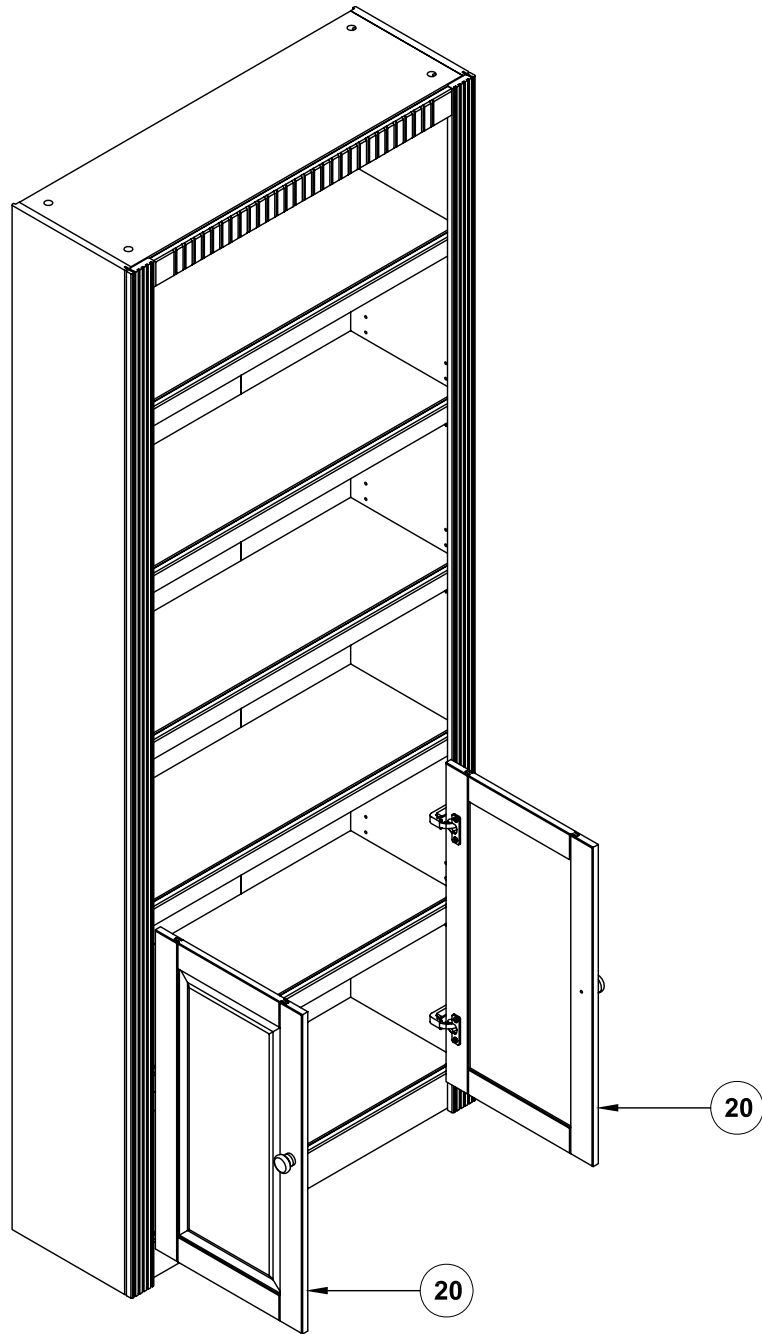

Türen einstellen (Scharniere justieren)
 Adjusting the doors (adjusting the hinges)
 Régler les portes (ajuster les charnières)
 Sistemare le porte (regolare le cerniere)
 Deuren instellen (scharnieren afstellen)
 Nastawić drzwi (wyregulować zawiasy)
 Vyrovnajte dviřka (seřid'te zavěsy)
 Nastavenie dverı (nastavenie zavesov)
 Allıtısa be az ajtokat (allıtısa be a zsanerokat)
 Reglare uși (ajustare balamale)
 Kapıların ayarlanması (menteşelerin seviye ayarı)
 Регулировка Дверей (регулировка шарнира)

