

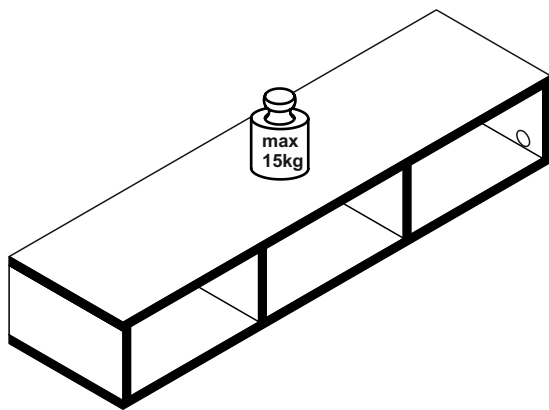

- | | | |
|---|--|--|
| (D) Videounterstützte Montageanleitung | (GB) Video-assisted assembly instructions | (FR) Instructions de montage assistées par vidéo |
| (TR) Video destekli kurulum talimatları | (IT) Istruzioni di montaggio video-assistite | (NL) Video-ondersteunde montage-instructies |
| (RU) инструкция по монтажу с помощью видеосигнала | (CZ) Instalační pokyny podporované videem | (HU) Video-támogatott telepítési utasítások |
| (RO) Instrucțiuni de instalare acceptate video | (PL) Instrukcje montażu wspomagane sygnałem wizyjnym | (SK) Inštaláčne pokyny podporované videom |

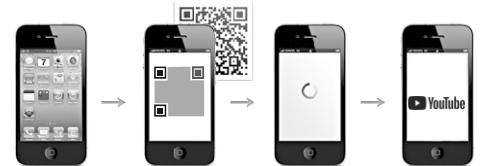

Art.-Nr.: **0617-HR_00**
Hängeregale

REPC-Nr.:



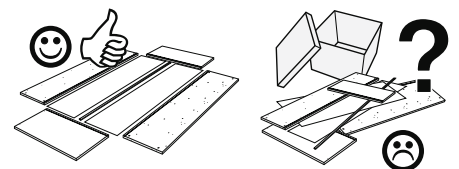
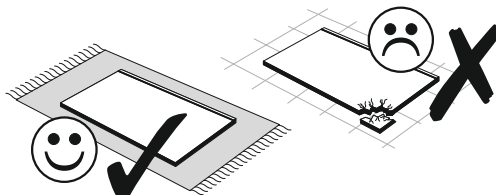
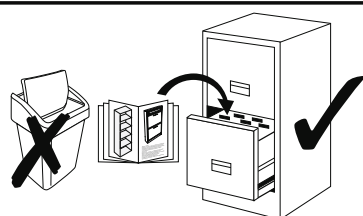
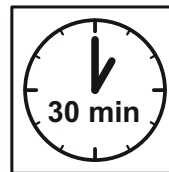
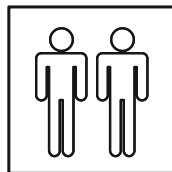
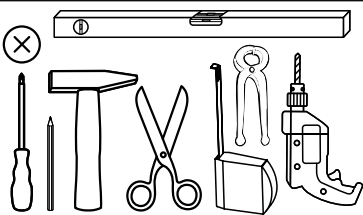





Service • Assistenza • Dienstverlening • Serwis
Servis • Szerviz • Сервисная служба

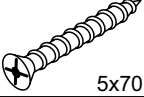

SCAN ME

Das Ersatzteil-Anforderungsformular finden Sie auf
The replacement parts requisition form you find on
<https://www.maeusbacher.de/ersatzteile/>

BT1-00163 Colli 1/1

B01-177-70		B02-10		B02-20		B02-103	
2x	5x70	14x		14x		8x	8x30
B05-01		B05-20		B05-130		B08-70	
2x		8x		2x		2x	Ø8

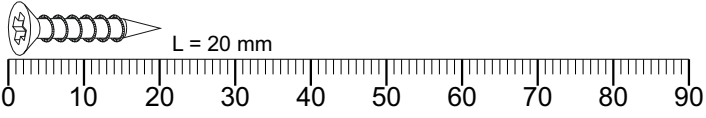

Colli 1/1

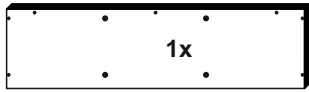

1182 x 315
FTx-000263



192 x 315
FTx-000266



192 x 291
FTx-000264

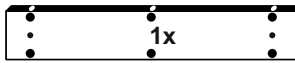

1151 x 192
FTx-000265

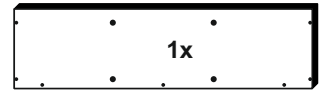

1182 x 315
FTx-000263

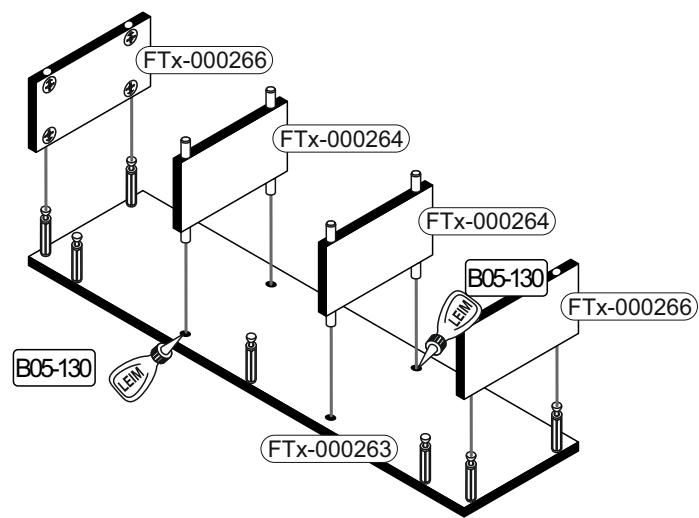
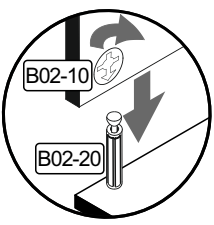
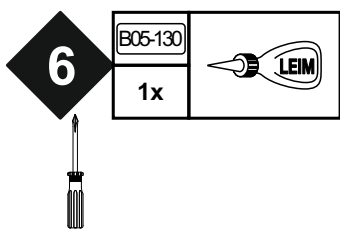
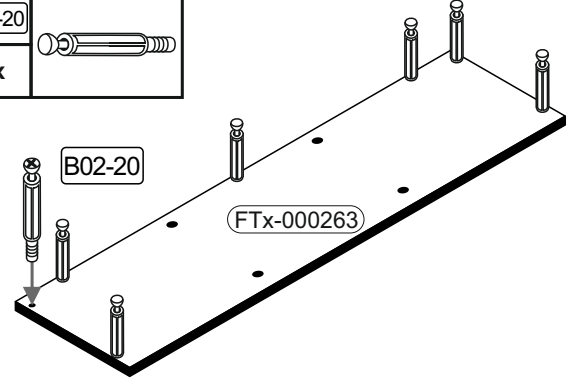
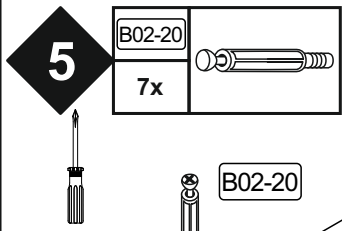
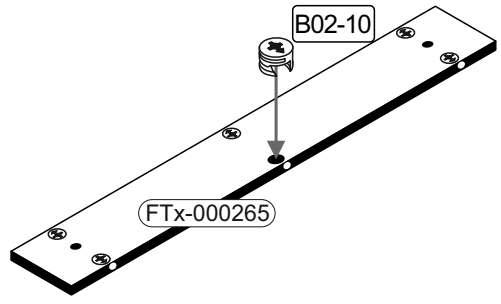
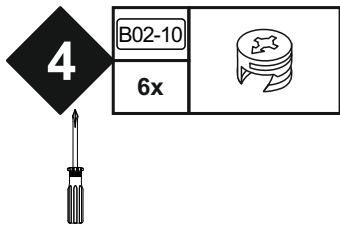
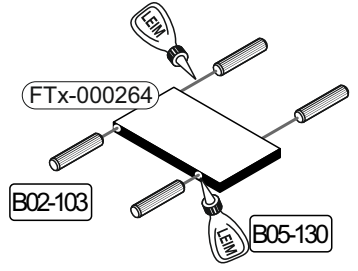
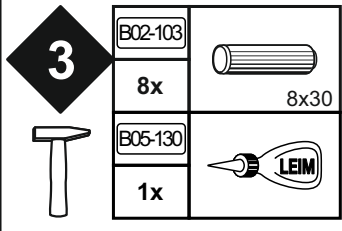
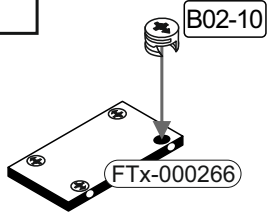
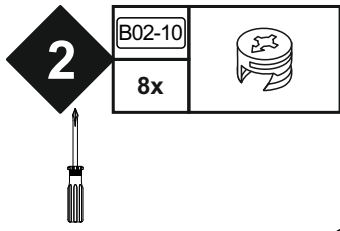
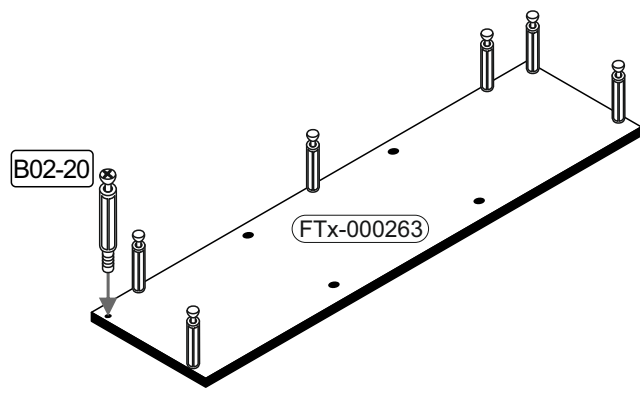
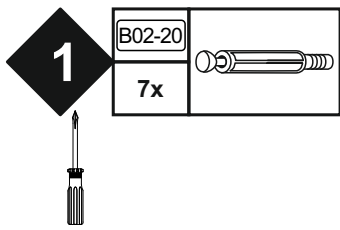

7

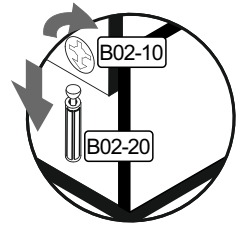
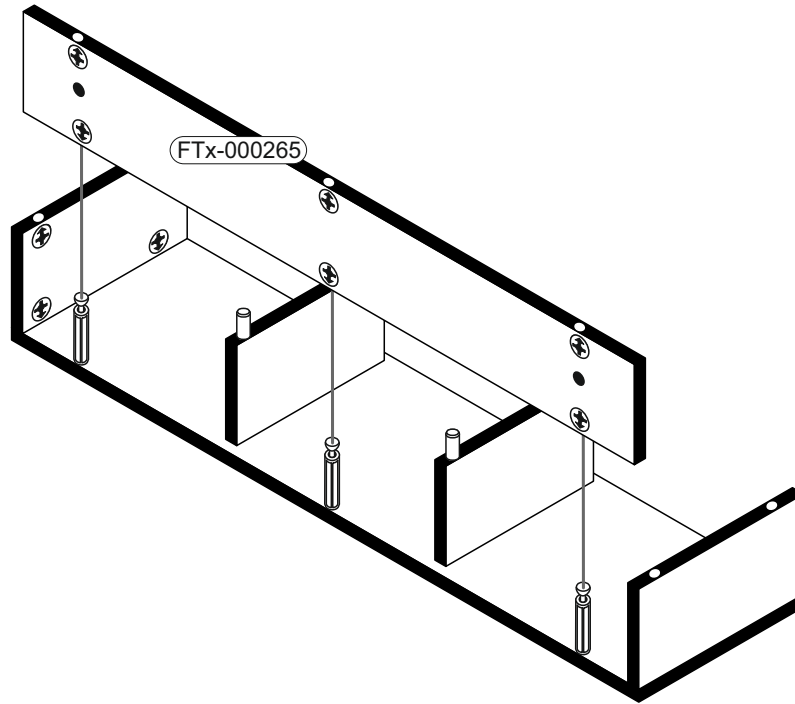

8



B05-130		B05-20	
1x		8x	

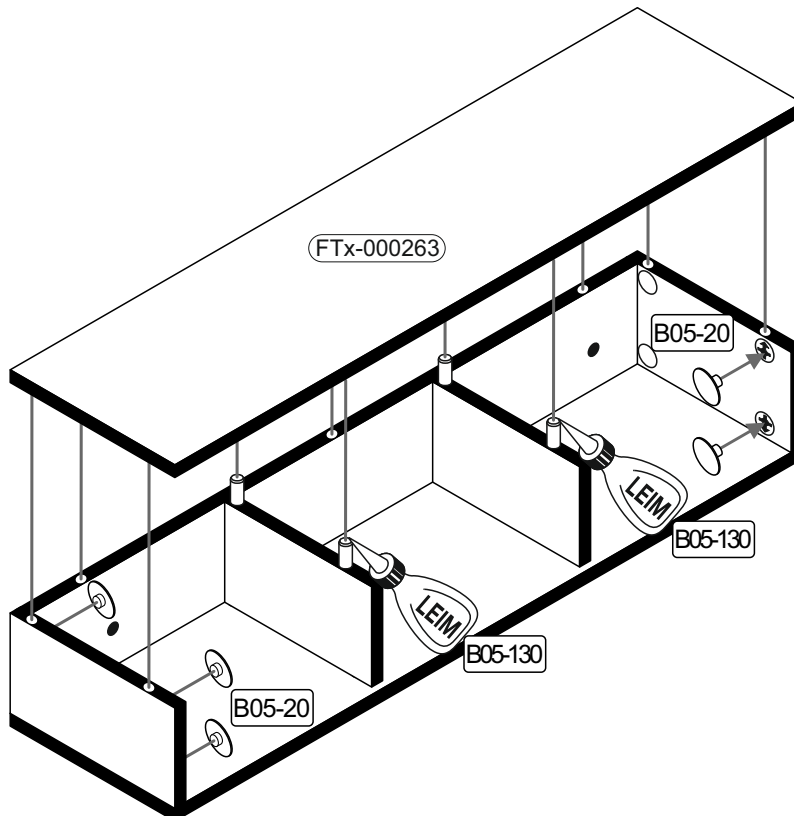



B05-01		B01-177-70		B08-70	
2x		2x	5x70	2x	Ø8

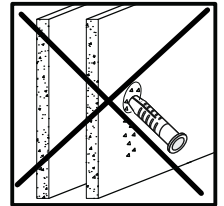
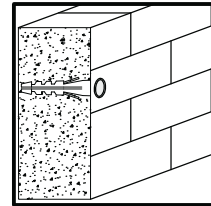
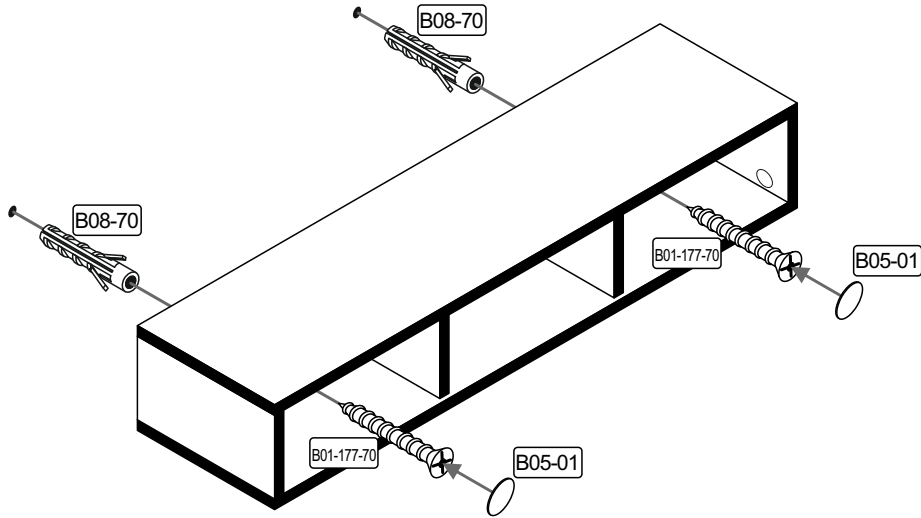

Achtung • Attention • Attenzione • Opgelet • Uwaga • Pozor • Figyelem • Atenție • Dikkat • Внимание	
(D)	Wandbefestigung dient als Kippschutz - unbedingt anbringen! Bei einigen Wandtypen kann ein Spezialdübel erforderlich sein!
(GB)	The wall fastening serves to prevent tipping - be absolutely sure to mount it! For certain wall types, a special wall plug may be necessary!
(FR)	La fixation murale sert de protection contre le basculement – à installer impérativement ! Pour certains types de murs il faut des chevilles spéciales !
(TR)	Duvardaki sabitleme, devrilmeye karşı bir emniyet tedbiridir ve mutlaka monte edilmelidir! Bazı duvar tiplerinde bunun için özel bir dübel gerekli olabilir!
(IT)	Il fissaggio alla parete serve da protezione anti-ribaltamento – attaccarla assolutamente! Per alcune strutture di parete può essere necessario un tassello speciale!
(NL)	Bevestiging aan de muur dient als kantelbescherming – zeker en vast bevestigen! Bij enkele muurtypes is een speciale plug misschien vereist!
(RU)	Обязательно установите крепление на стене во избежание опрокидывания! Для некоторых типов стен может потребоваться специальный дюбель!
(CZ)	Montáž na stěnu slouží jako ochrana proti převrnutí – bezpodmínečně umístěte! U některých typů stěn může být zapotřebí speciální hmoždinka!
(HU)	A terméket a falhoz kel rögzíteni, különben az felborulhat! Egyes faltípusoknál speciális tiplit kell használni!
(RO)	Sistemul de fixare la perete servește ca protecție la răsturnare - de montat obligatoriu! Pentru unele tipuri de pereți este posibil să fie necesar un diblu special!
(PL)	Mocowanie do ściany jest jednocześnie zabezpieczeniem przed przewróceniem – koniecznie zamontować! Do niektórych rodzajów ścian koniecznie zastosować specjalne kołki mocujące.
(SK)	Upevnenie na stenu slúži ako ochrana proti prevráteniu – bezpodmienečne použite! Pre niektoré druhy stien môže byť potrebná špeciálna hmoždinka!



▶ SCAN ME

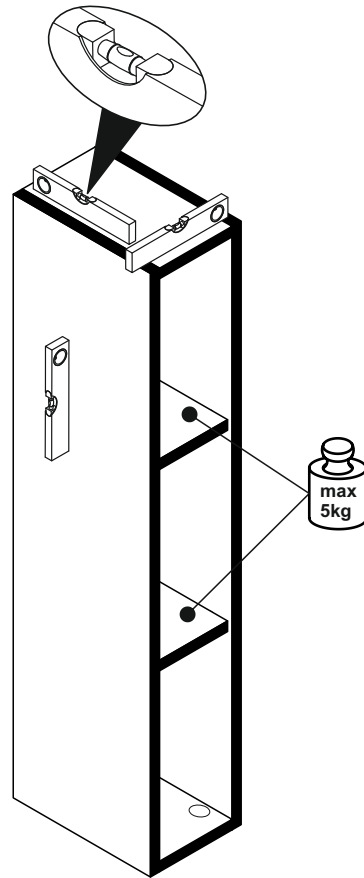

vertikale Aufhängung

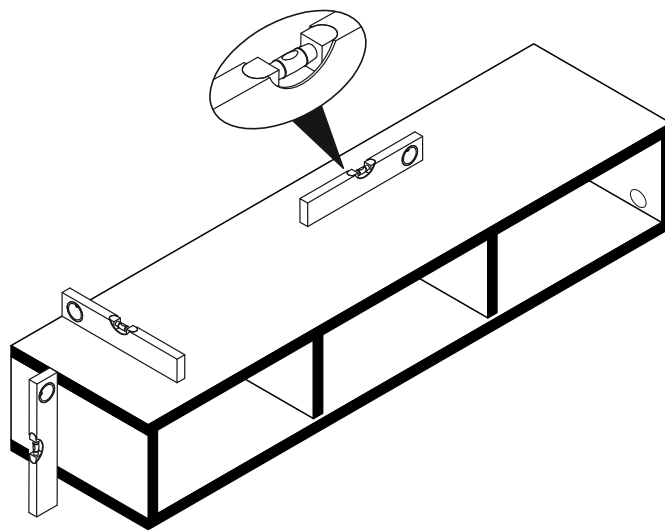

horizontale Aufhängung