

# 80-20101-40

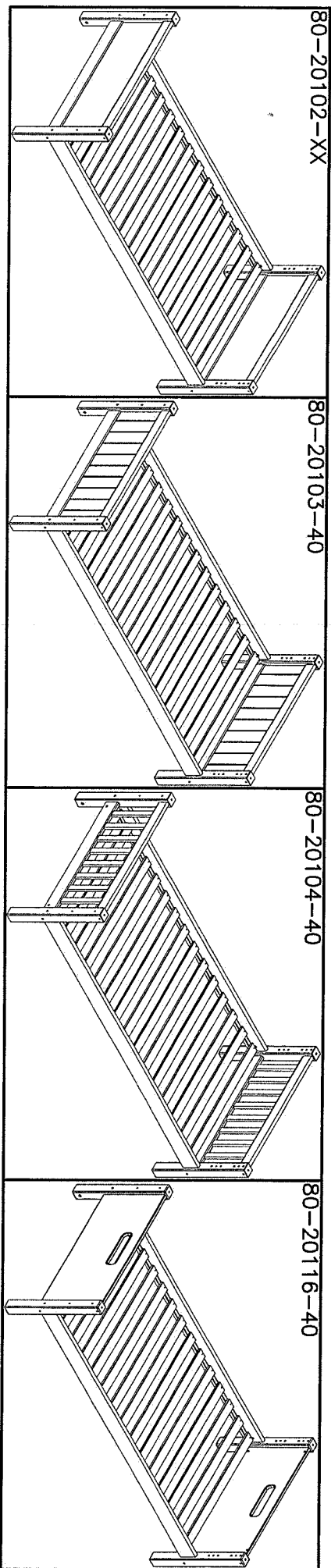

See assembly instruction in box no.  
 Voir notice de montage dans la caisse no.  
 Siehe Aufbauanleitung im Karton no.  
 Zie voor de montage-instructie pakketnr.

Before assembling this product, please ensure that all the components supplied comply with the list on this page. All Screw-type fittings can be tightened with this tool.

Avant de commencer l'assemblage, veuillez vérifier si tous les objets indiqués sont présents. Tous les vis peuvent être serrés par cet outil.

Bevor Sie mit dem Aufbau beginnen, kontrollieren Sie ob alle auf der Zeichnung angegebenen Teile vorhanden sind. Bitte verwenden Sie zur Montage einen Kreuzschraub- und den beiliegenden Inmenschlüssel.

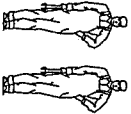

| Ware-nr.<br>Part No.<br>Réf. No.               | Stück-<br>Qty.<br>Qté. |
|--|------------------------|
| Siehe Bild-nr.<br>See picture no.<br>Image no. | Mess-<br>Dim.          |

12-06306473-40

2 stick/pcs.

12-06306474-40

2 stick/pcs.

1.305-19672-40

2 stick/pcs.

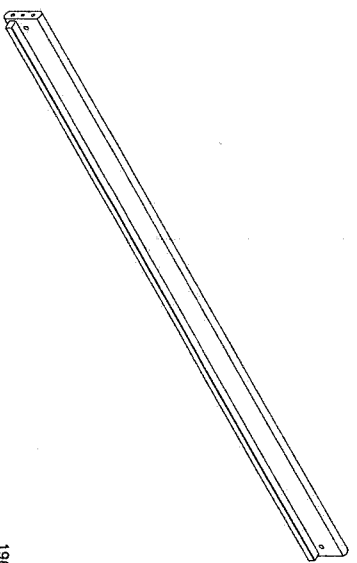
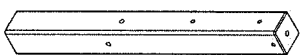
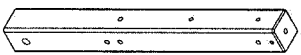

1967x115x26

A 3922-08018 8 stick/pcs. 647x63x63

B 3930-10050 16 stick/pcs. 3909-70100

C 647x63x63 4 stick/pcs. 3901-40030

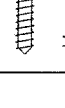

Z1 M8/ø12x18 mm. 8 stick/pcs. 3938-00081-2

Z2 ø10x50 mm. 16 stick/pcs. 3938-00010-2

Z3 3938-00016-2 16 stick/pcs.

Z4 ø7x100 mm. 20 stick/pcs.

64x30 mm. 4 stick/pcs. 4033-005

1 stick/pcs. 4033-005

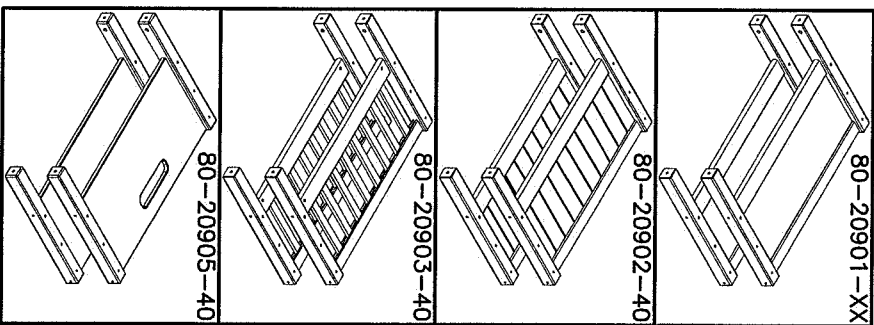
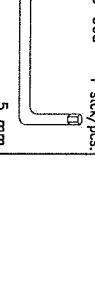
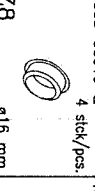
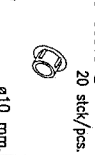
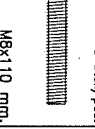
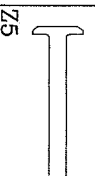

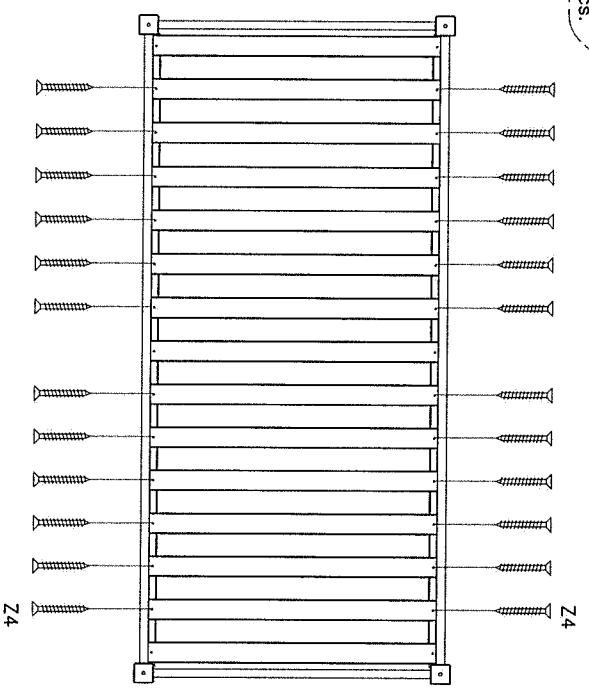
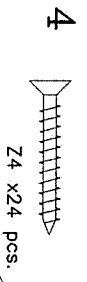
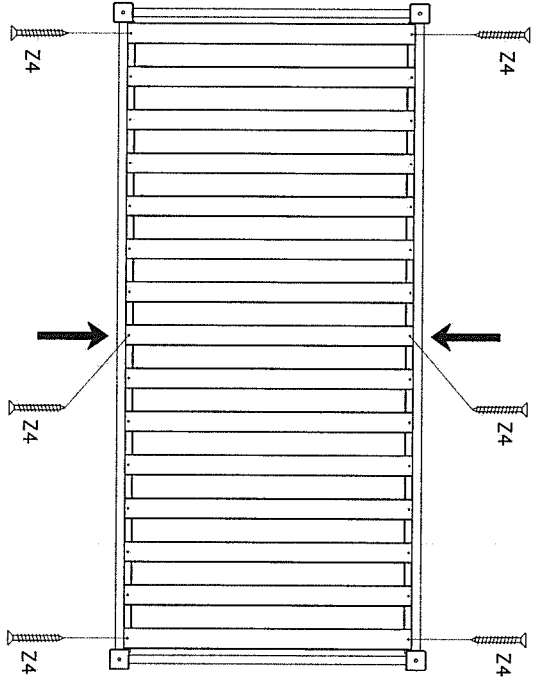
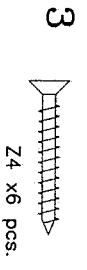
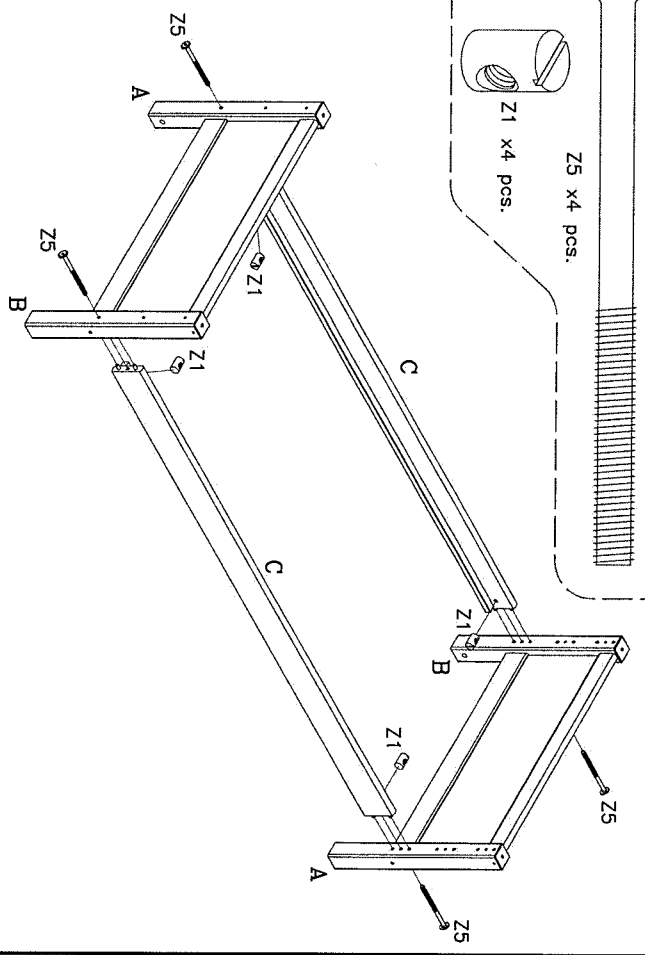
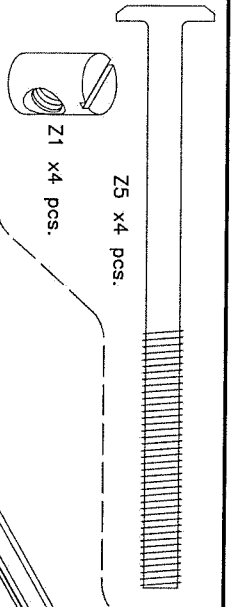
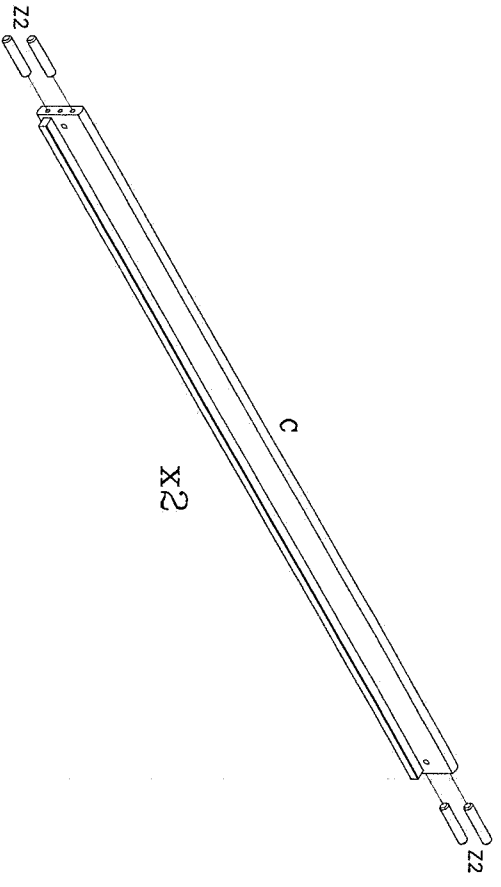
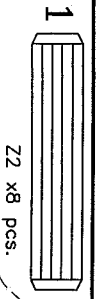

# 80-20905-40 White

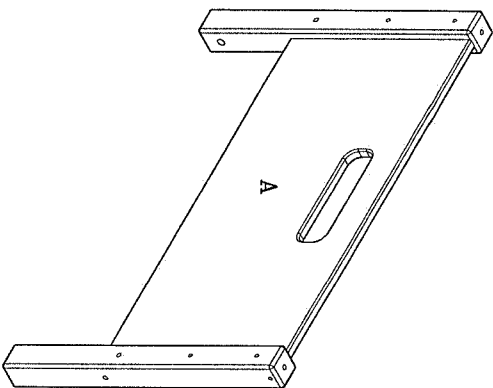

**Before assembling this product, please ensure that all the components supplied comply with the list on this page. All Screw-type fittings can be tightened with this tool.**

**Avant de commencer l'assemblage, veuillez contrôler si tous les objets indiqués sont présents. Tous les vis peuvent être serrés par cet outil.**

**Bevor Sie mit dem Aufbau beginnen, kontrollieren Sie ob alle auf der Zeichnung angegebenen Teile vorhanden sind. Bitte verwenden Sie zur Montage einen Kreuzschraubenzieher und den beiliegenden Insechschlüssel.**

**Wart.-nr. Part no. Réf. No. Stück Qty. Qty. Mess Dim. Dim.**  
 Siehe Bild-nr. See picture no. Imoge no.

|                 |              |  |             |                       |                    |
|-----------------|--------------|--|-------------|-----------------------|--------------------|
| 4301-2208631-40 | 2 stick/pcs. |  | M6/Ø10x18mm | 4 stick/pcs. 4033-004 | 1 stick/pcs. 4 mm. |
| 3922-060181     | 4 stick/pcs. |  | M6x110      | 4 stick/pcs. 4033-004 | 1 stick/pcs. 4 mm. |
| 863x431x22      | Z29          |  | M6x110      | 4 stick/pcs. 4033-004 | 1 stick/pcs. 4 mm. |
|                 | Z28          |  | M6x110      | 4 stick/pcs. 4033-004 | 1 stick/pcs. 4 mm. |

Z1, Z2, Z5 Fittings in single / bunk bed box.  
 Z1, Z2, Z5 Beschläge im Einzel- / Etagenbett Karton.  
 Z1, Z2, Z5 Raccords en lit simple / lit superposé.  
 Z1, Z2, Z5 Fittings in het enkelspel / stapelbed boxen.

|   |   |
|---|---|
| <p><b>1</b></p> <p>Z2 x8 pcs.</p>                                 | <p>Z2 Z28</p>   |
| <p><b>2a</b></p> <p>Z29 x2 pcs.<br/>Z5 x2 pcs.<br/>Z1<br/>Z28</p> | <p><b>2b</b></p> <p>Z29 x2 pcs.<br/>Z5 x2 pcs.<br/>Z1<br/>Z28</p> |
| <p><b>3a</b></p> <p>Z29 x2 pcs.<br/>Z5 x2 pcs.<br/>Z1<br/>Z28</p> | <p><b>3b</b></p> <p>Z29 x2 pcs.<br/>Z5 x2 pcs.<br/>Z1<br/>Z28</p> |

Bunk bed only. Nur Etagen Bett.  
 Lits superposés seulement. Alleen stapelbed

# 80-20601-40

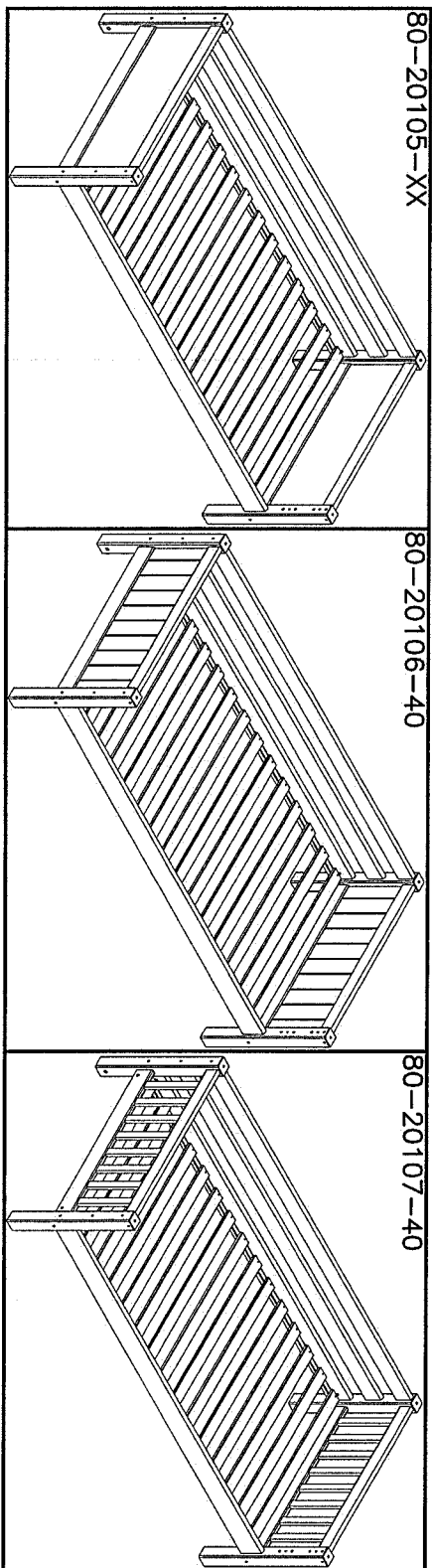

Before assembling this product, please ensure that all the components supplied comply with the last of this page. All the parts must be tightened with this tool.

Avant de commencer l'assemblage, veuillez contrôler si tous les objets indiqués sont présents. Tous les vis doivent être serrés par cet outil.

Bevor Sie mit dem Aufbau beginnen, kontrollieren Sie ob alle auf der Zeichnung angegebenen Teile vorhanden sind. Bitte verwenden Sie zur Montage einen Kreuzschraubenzieher und den Mitessgarden Innerschraubenschlüssel.

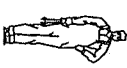
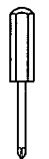

Ware-nr.  
Part no.  
Réf. No

Stück.  
Qty.  
Qté.

Steh Bild-nr.  
See picture no.  
Image no

Mess  
Dim.  
Dim.

12-02619676-40

2 stck./psc.

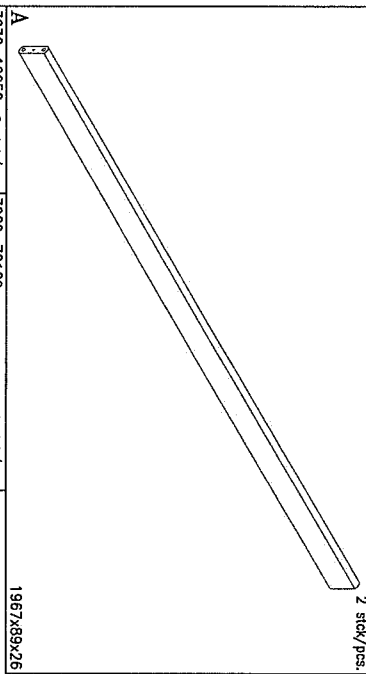

3930-10050 8 stck./psc. 3909-70100

4 stck./psc.

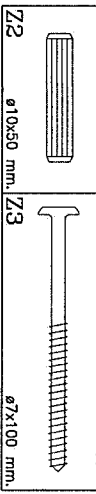

1967x89x26

Z3

1967x89x26

See assembly instruction in box no. 80-20101-40

Voir notice de montage dans la caisse no. 80-20101-40

Steh Aufbauanleitung im karton no. 80-20101-40

Zie voor de montage-instructie pakketnr. 80-20101-40

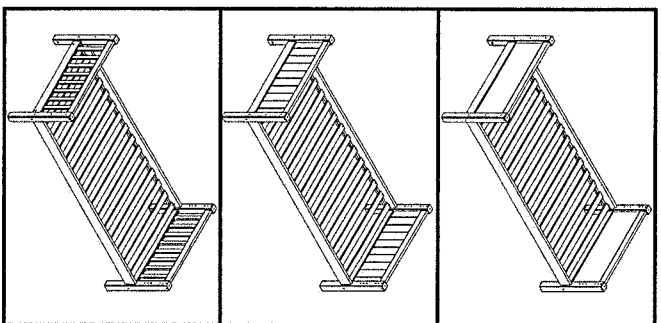



Z2 x8 pcs.

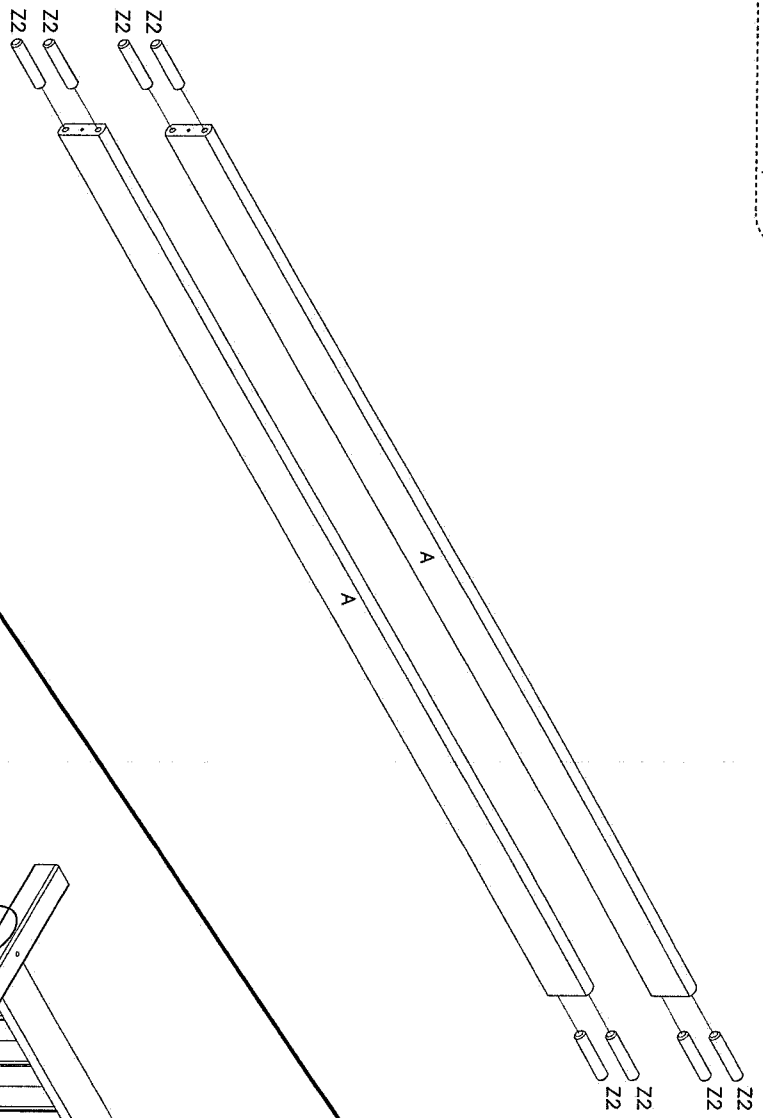

2

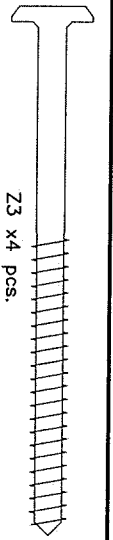

Z3 x4 pcs.

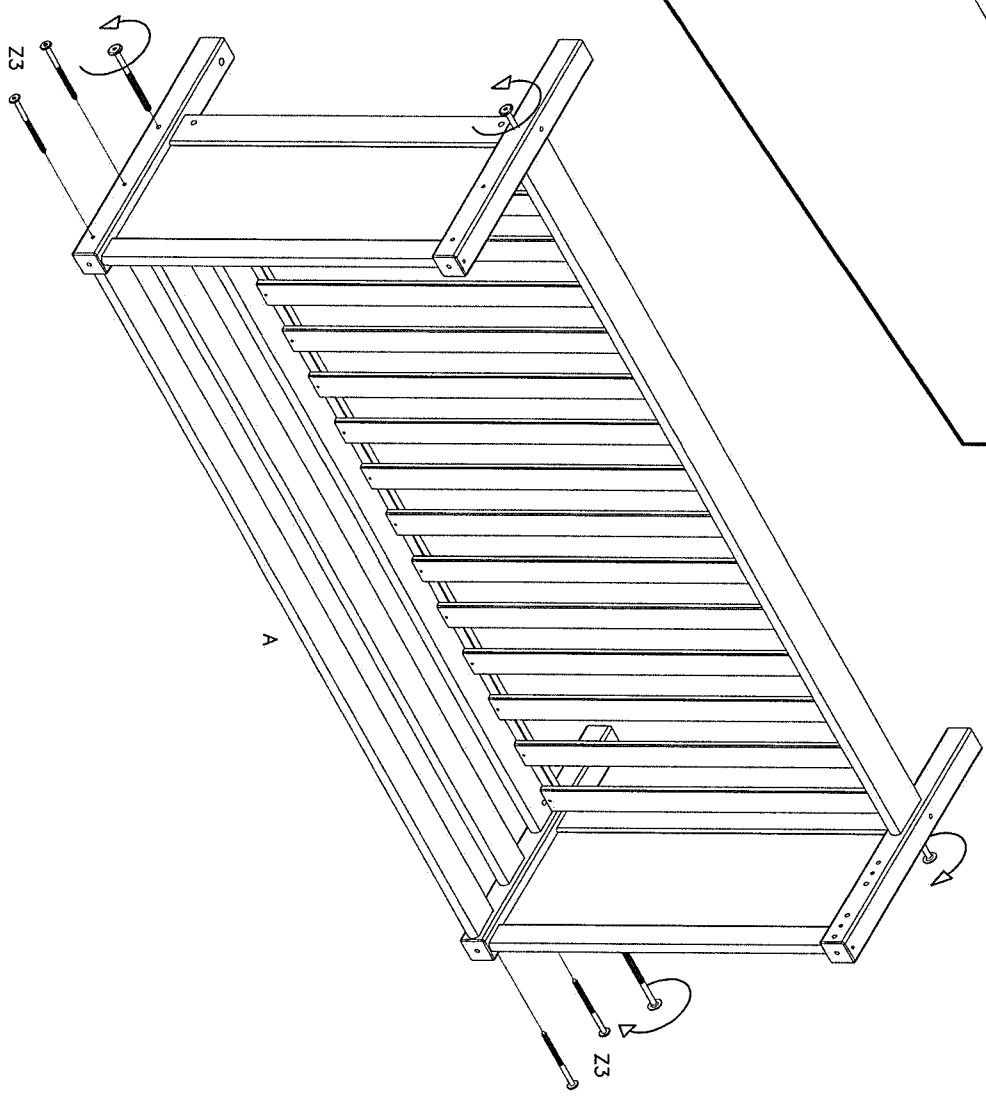

# 80-20602-40

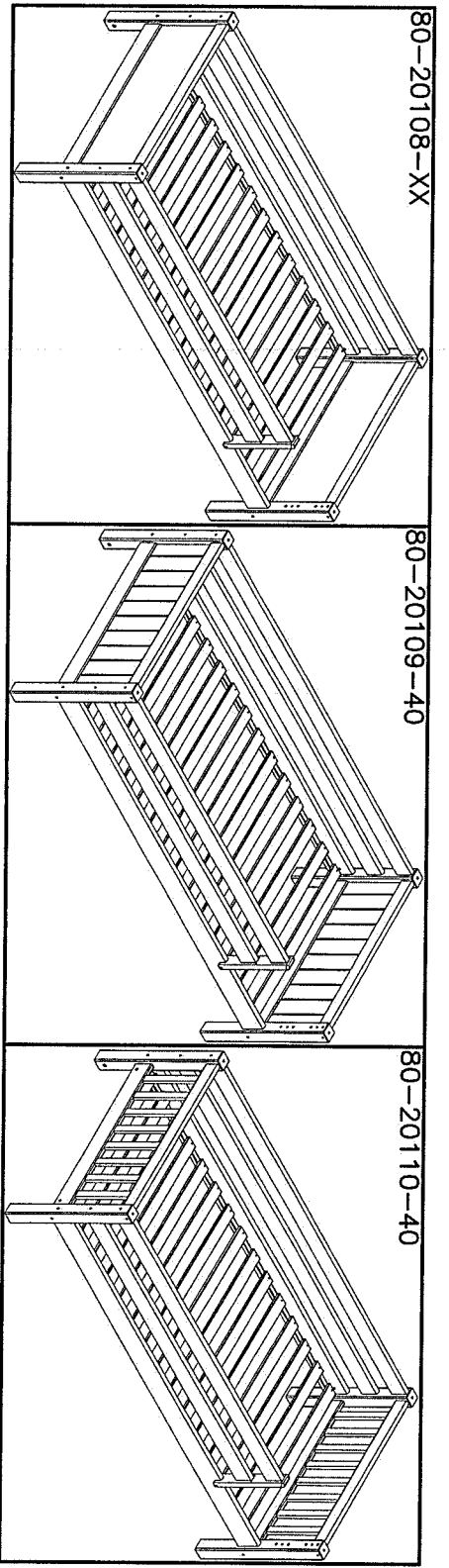

Before assembling this product, please ensure that all the components supplied comply with the list on this page. All Screw-type fittings can be tightened with this tool.

Avant de commencer l'assemblage, veuillez contrôler si tous les objets indiqués sont présents. Tous les vis peuvent être serrés par cet outil.

Bevor Sie mit dem Aufbau beginnen, kontrollieren Sie ob alle auf der Zeichnung angegebenen Teile vorhanden sind. Bitte verwenden Sie zur Montage einen Kreuzschraub-ziehler und den beiliegenden Innensechskantschlüssel.



2 stick/pcs.

| Ware-nr.<br>Part no.<br>Réf. No. | Stück.<br>Qty.<br>Qté. |
|----------------------------------|------------------------|
| 12-02615712-40                   | 2 stick/pcs.           |
| 12-02603611-40                   | 1 stick/pcs.           |

Steh-Bild-nr.  
See picture no.  
Image no.

Maß  
Dim.  
Dim.

361x65x26

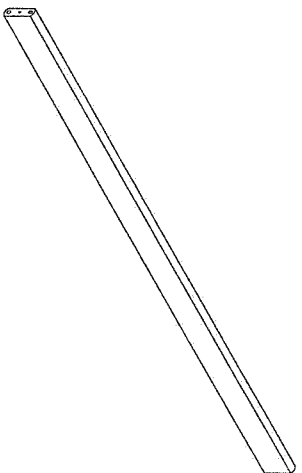
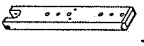

1571x89x26

A

|            |              |            |              |
|------------|--------------|------------|--------------|
| 3930-10050 | 8 stick/pcs. | 3909-70100 | 2 stick/pcs. |
| Z2         | ø10x50 mm.   | Z3         | ø7x100 mm.   |
| 3901-40030 | 2 stick/pcs. | 3909-70060 | 2 stick/pcs. |



Z4

|           |     |           |
|-----------|-----|-----------|
| ø4x30 mm. | Z15 | ø7x80 mm. |
|-----------|-----|-----------|

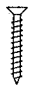

See assembly instruction in box no. 80-20101-40

Voir notice de montage dans la coisse no. 80-20101-40

Siehe Aufbauanleitung im Karton no. 80-20101-40

Zie voor de montage-instructie pakketnr. 80-20101-40

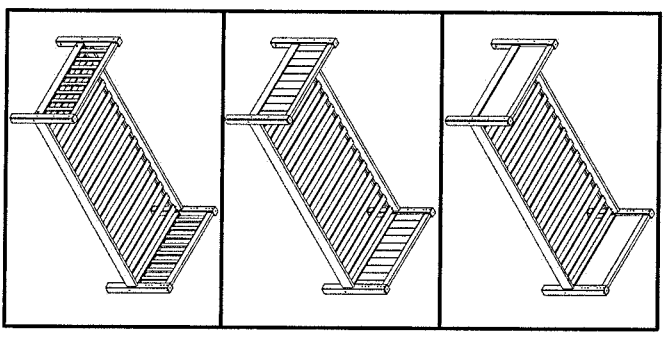



Z2 x8 pcs.

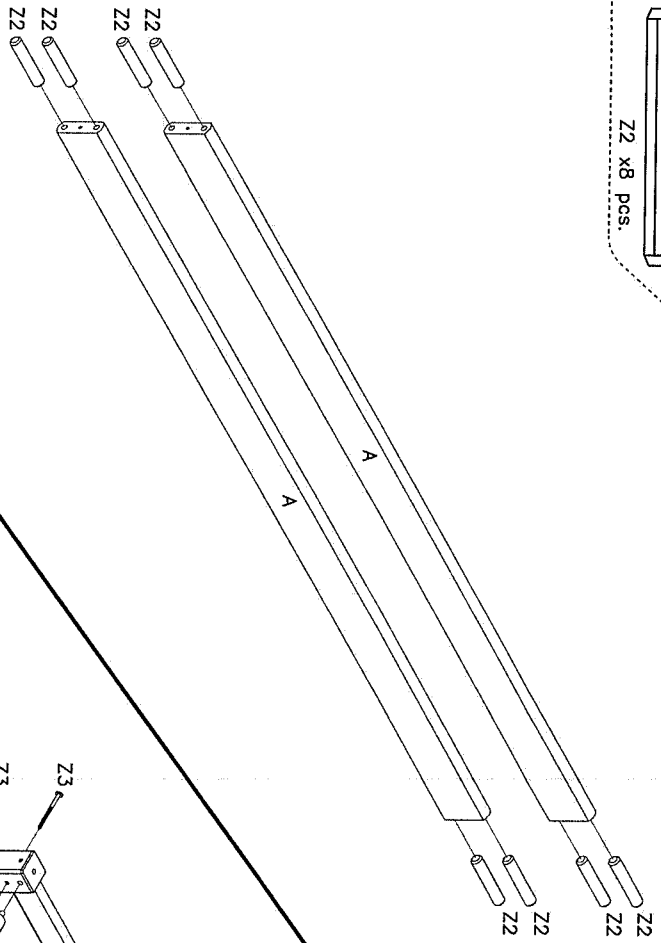

2

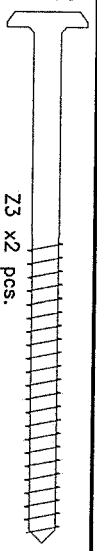

Z3 x2 pcs.

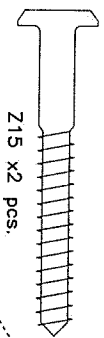

Z15 x2 pcs.

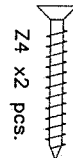

Z4 x2 pcs.

