



D Montageanleitung

F Notice de montage

NL Handleiding voor de montage

CZ Monzázní návod

HU Szerelési útmutató

TR Montaj talimatı

GB Assembly instructions

I Istruzione di montaggio

PL Instrukcja montaży

SK Návod na montáž

RO Instrucțiuni de montaj

RU ИНСТРУКЦИЯ ПО МОНТАЖУ

Art. Nr. 1041-Lö

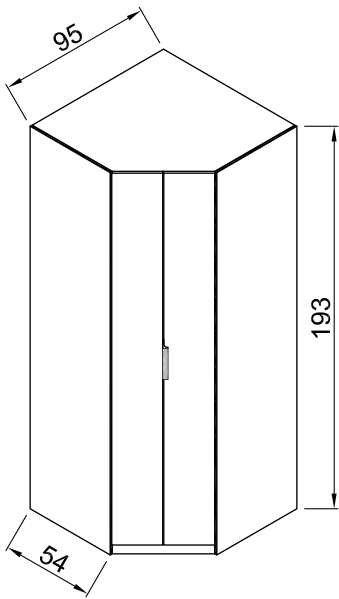

Art. Nr. 1041

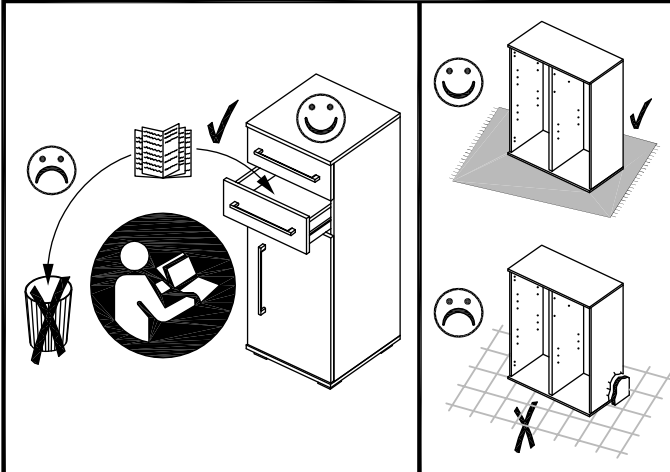
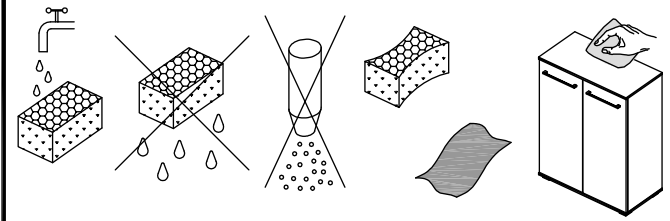
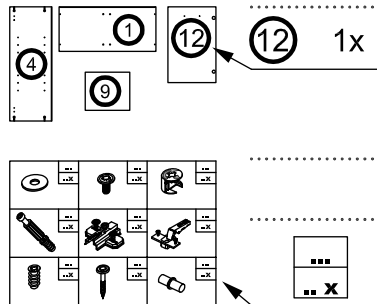

 3,5 x 13 62 12x	 4x13 72 7x	 108 6x
 Ø 15 x 11,5 142 8x	 6 x 44 143 8x	 4,5 x 55 222 12x
 563 mm 295 2x	 1834 mm 297 1x	 364 6x
 4 x 15 928 2x	 575 1x	 Ø 12 / 2,5 903 12x
 908 4x	 916 28x	 921 10x
 6,3 x 11 927 10x	 4 x 15 928 12x	 941 4x

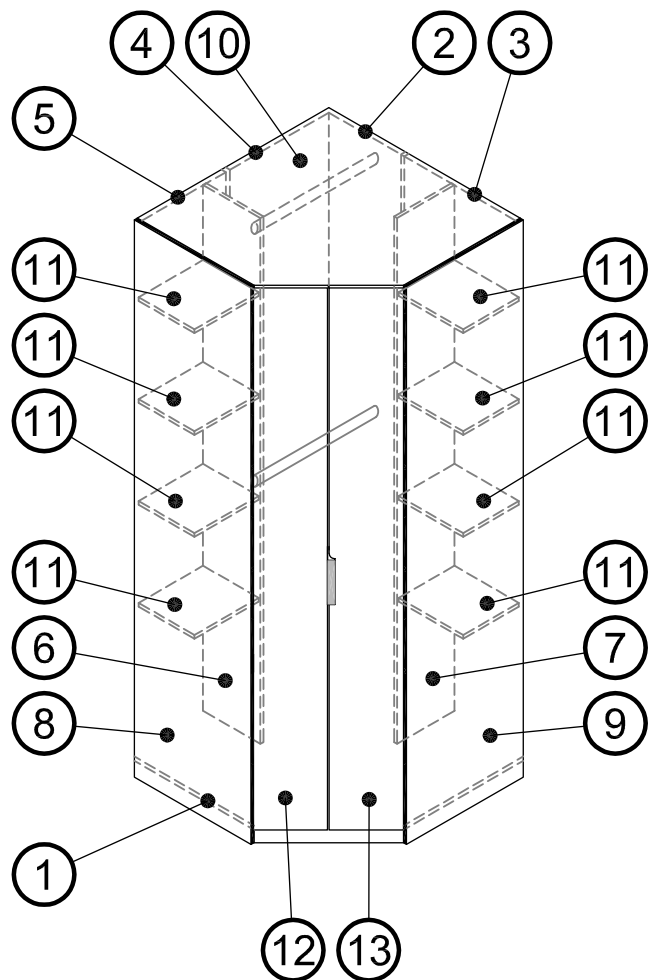

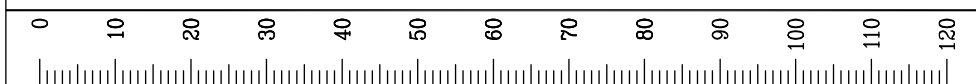
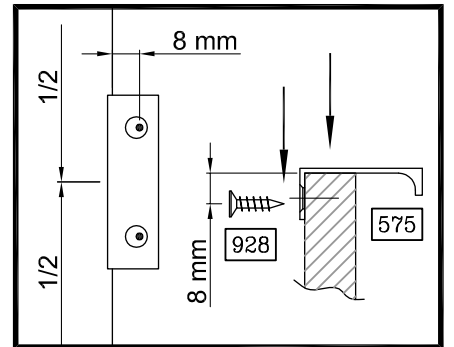
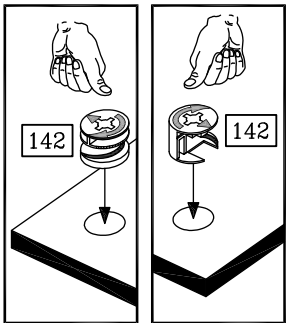
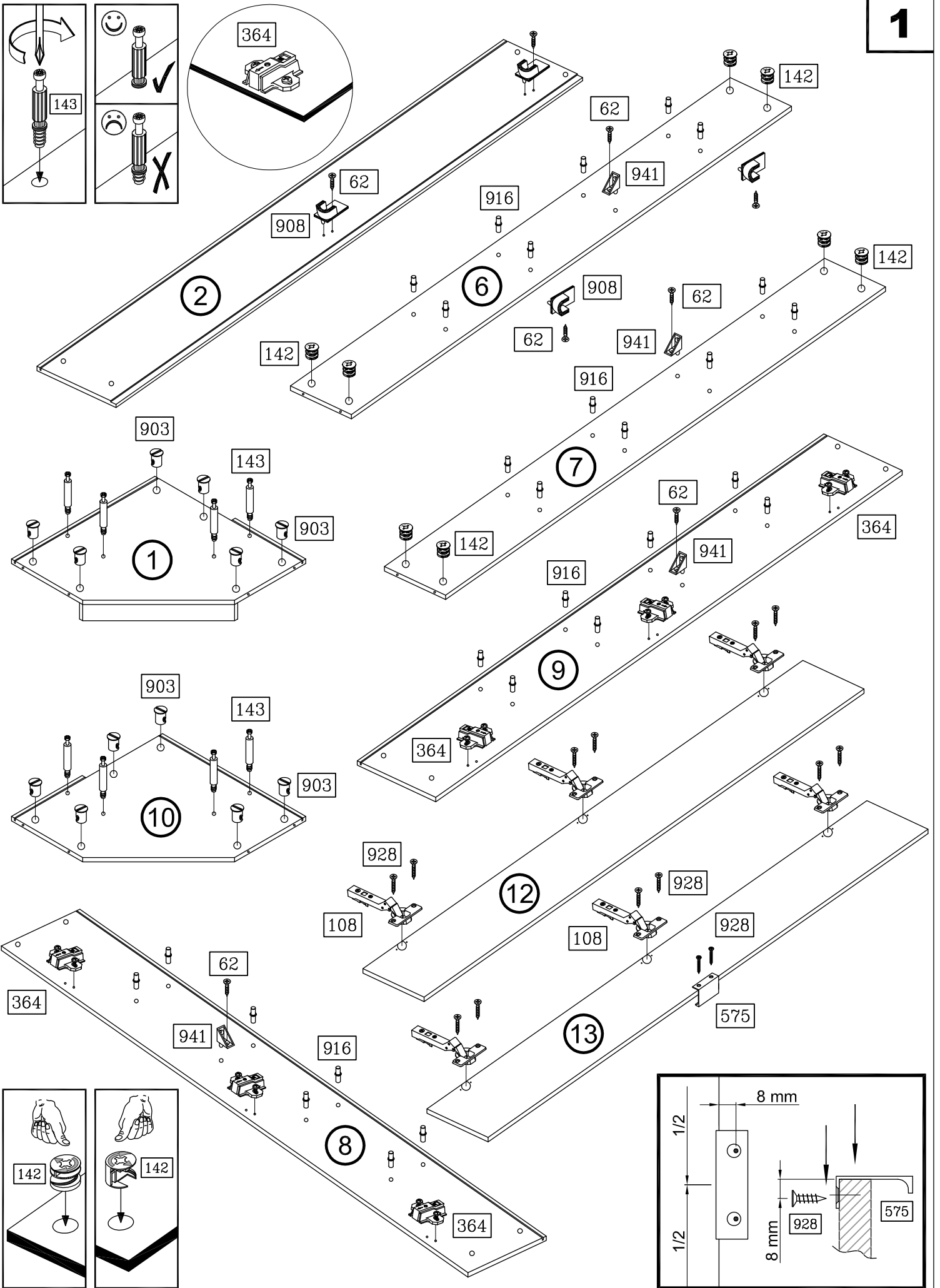
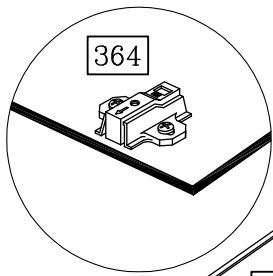
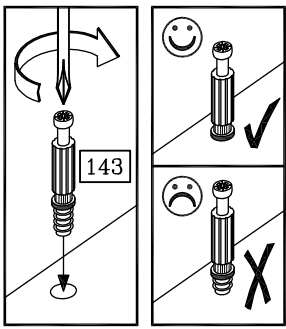

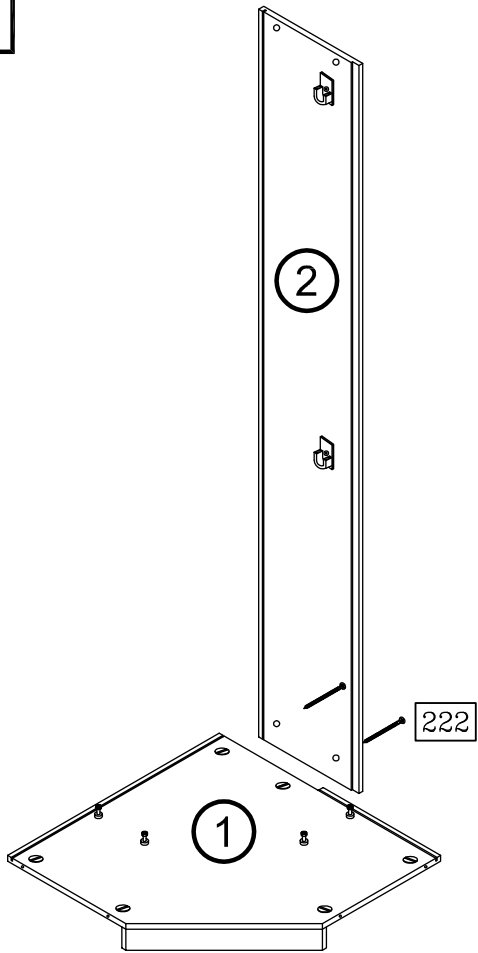
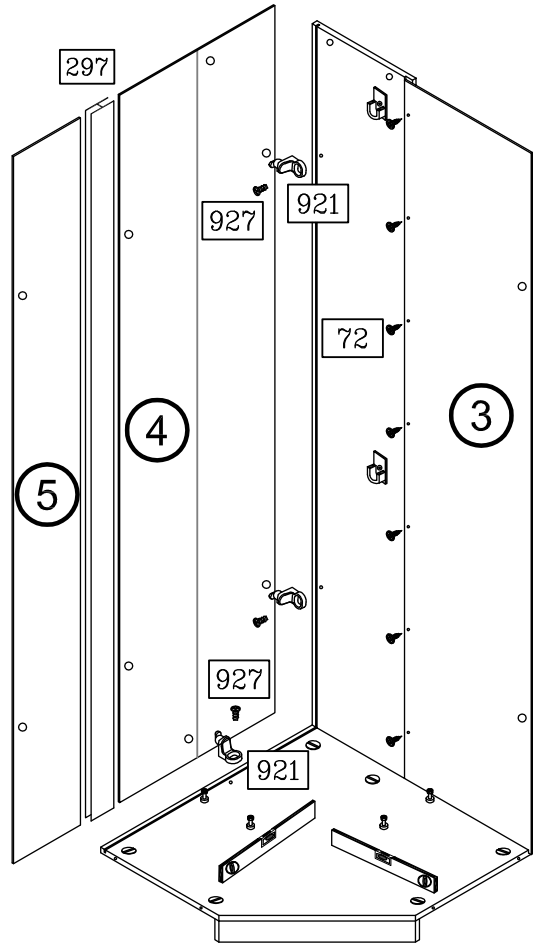
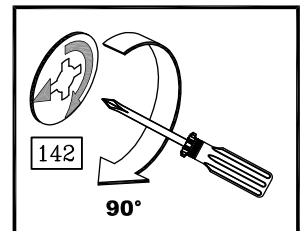
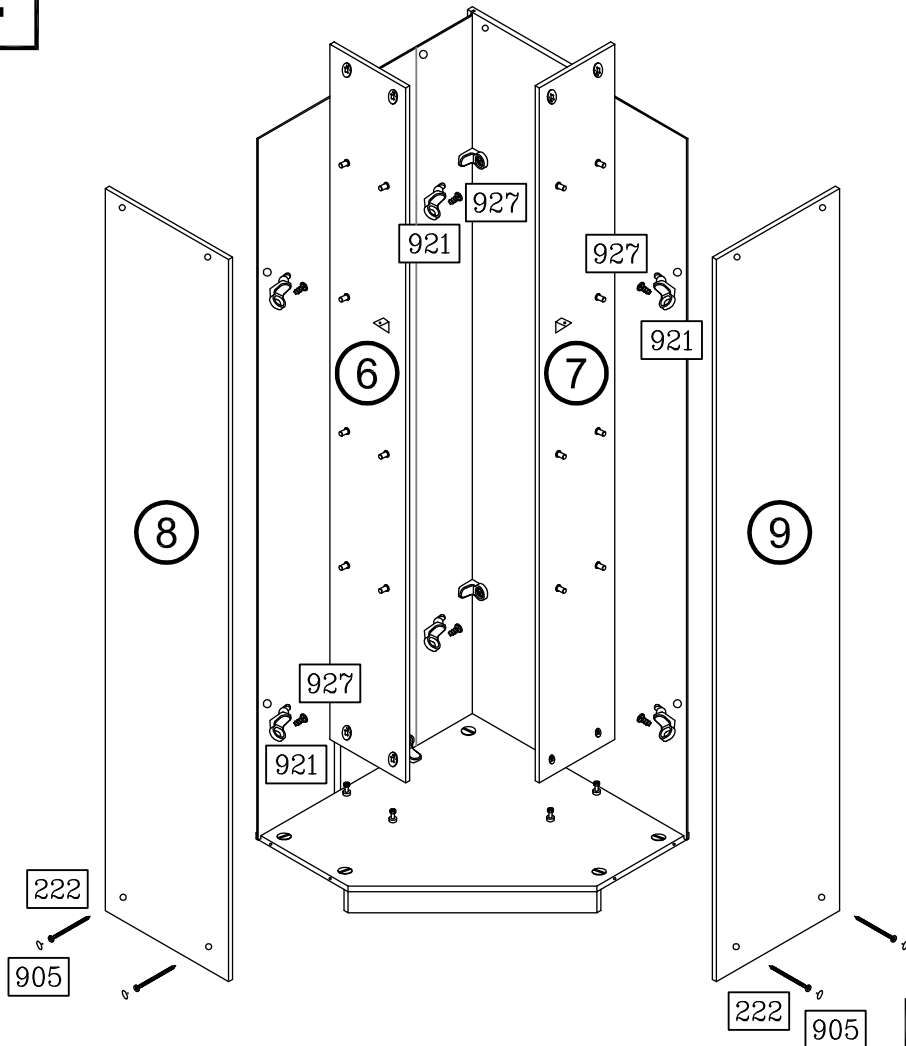
2**3****4**

1041-Lö-2

3/4

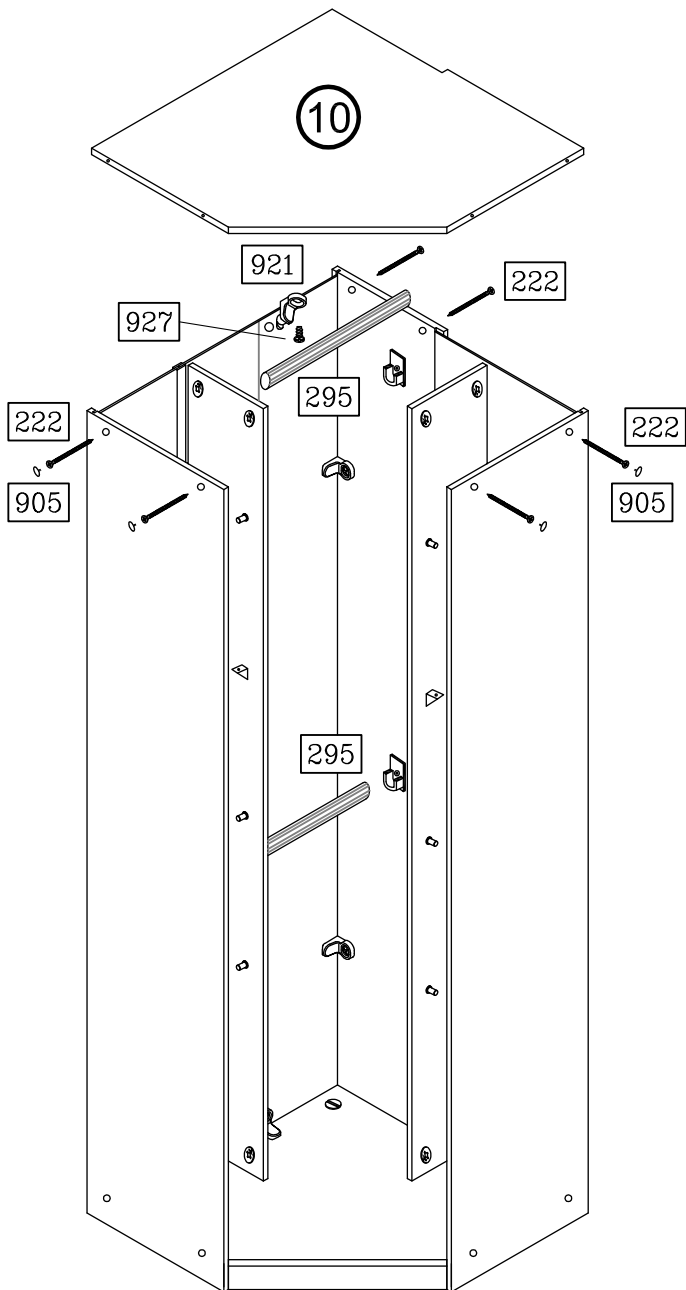
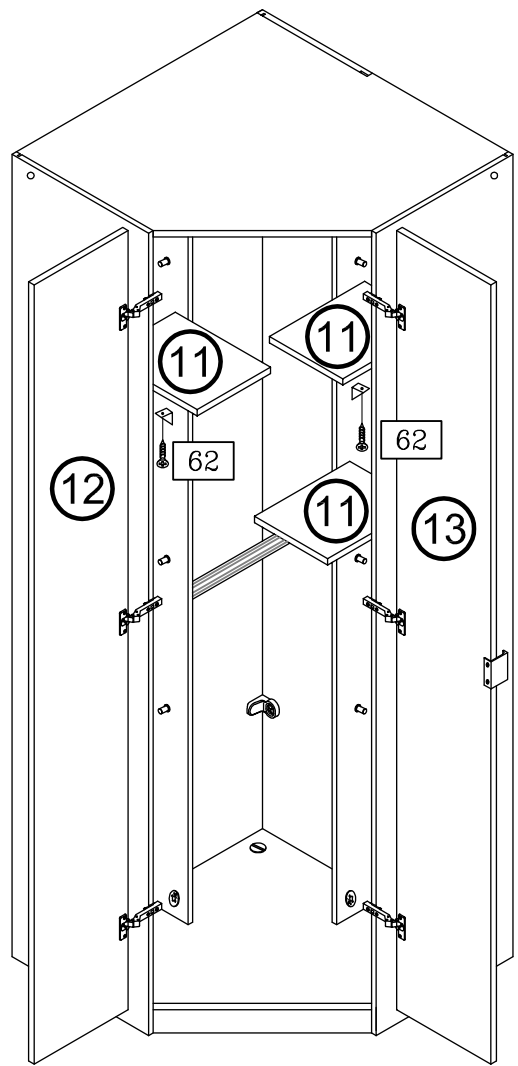
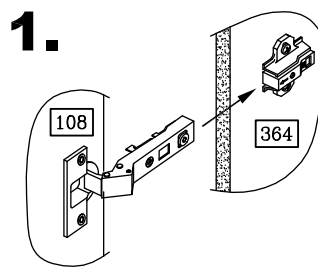
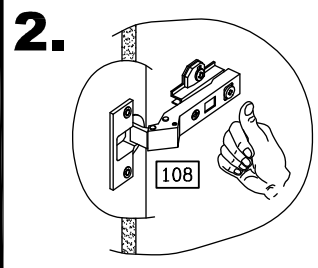
5**6****1.****2.****7**