

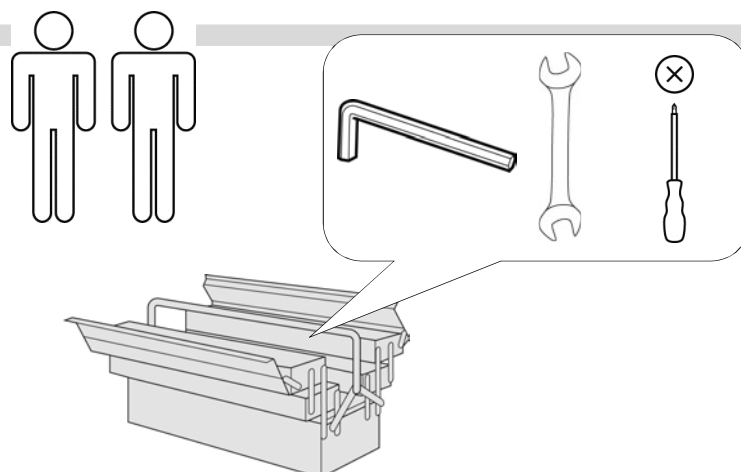

- | | |
|----------------------------------|---------------------------------------|
| D Montageanleitung | GB Assembly instructions |
| FR Notice de montage | NL Handleiding voor de montage |
| CZ Montážní návod | IT Istruzioni di montaggio |
| RO Instrucțiuni de montaj | RU инструкция по сборке |
| PL Instrukcja montażu | SK Návod na montáž |
| HU Szerelési útmutató | TR Montaj talimati |

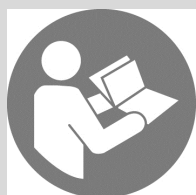

Bei der Montage Kopfteilbrett unbedingt beachten !

**Bettkasten
Außenseite**

**Teil 4
Bettseite-
Innen**

Kopfteilbrett vor der Montage

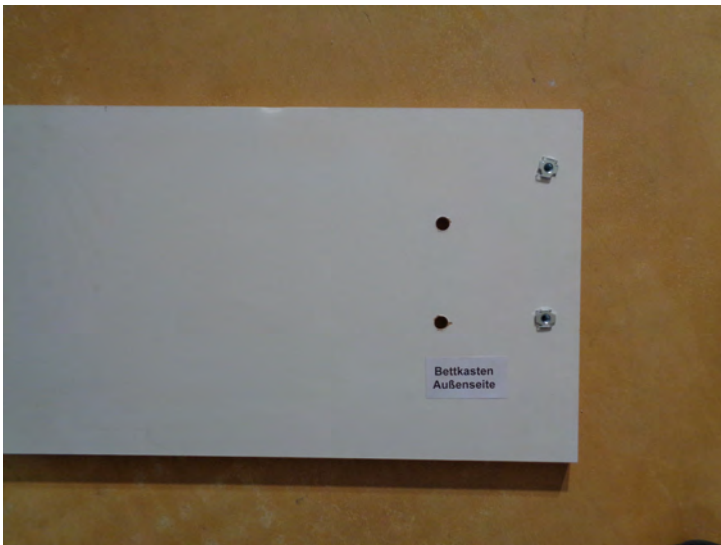

Kopfteilbrett nach der Montage



0
10
20
30
40
50
60
70
80
90
100
110
120
130
140
150
160
170
180
190
200



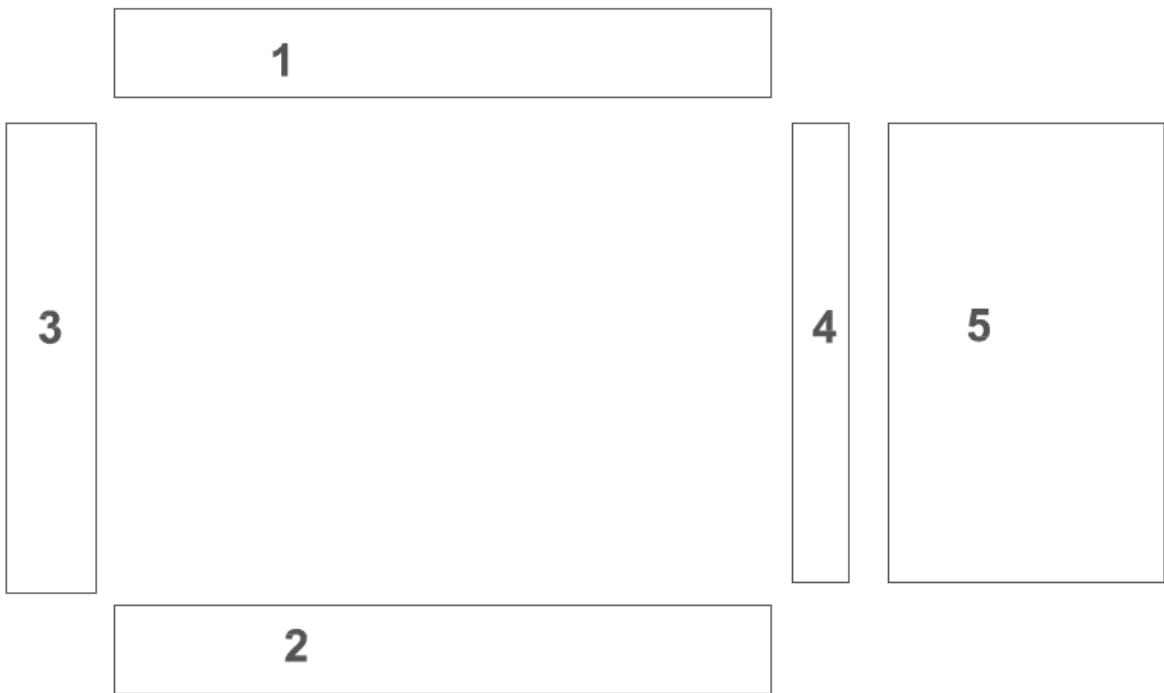

| Service • Assistenza • Dienstverlening • Serwis Servis • Szerviz • Сервисная служба | |
|--|-------------------|
| Name • Nom • Nome • Naam Nazwa • Jméno • Názov • Név Denumire • İsim • Название | Roswell EB |
| Nr. • No. • N° • Номер • Č • Sz | SH43-51 |
| Typ • Type • Tip • Típus • Тіро Тип | BK zerl. |
| | |
| | |



| A | B | C | D | E |
|----------|----|------------|----|----|
| | | | | |
| 16x 6x30 | 4x | 16x 3,5x20 | 4x | 4x |

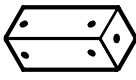

| G | H | I |
|----------|---------|----|
| | | |
| 4x M8x20 | 4x 8x20 | 4x |

| P | Q | R |
|---------|---------|-------|
| | | |
| 4x 8x60 | 4x 8x40 | 4x M8 |

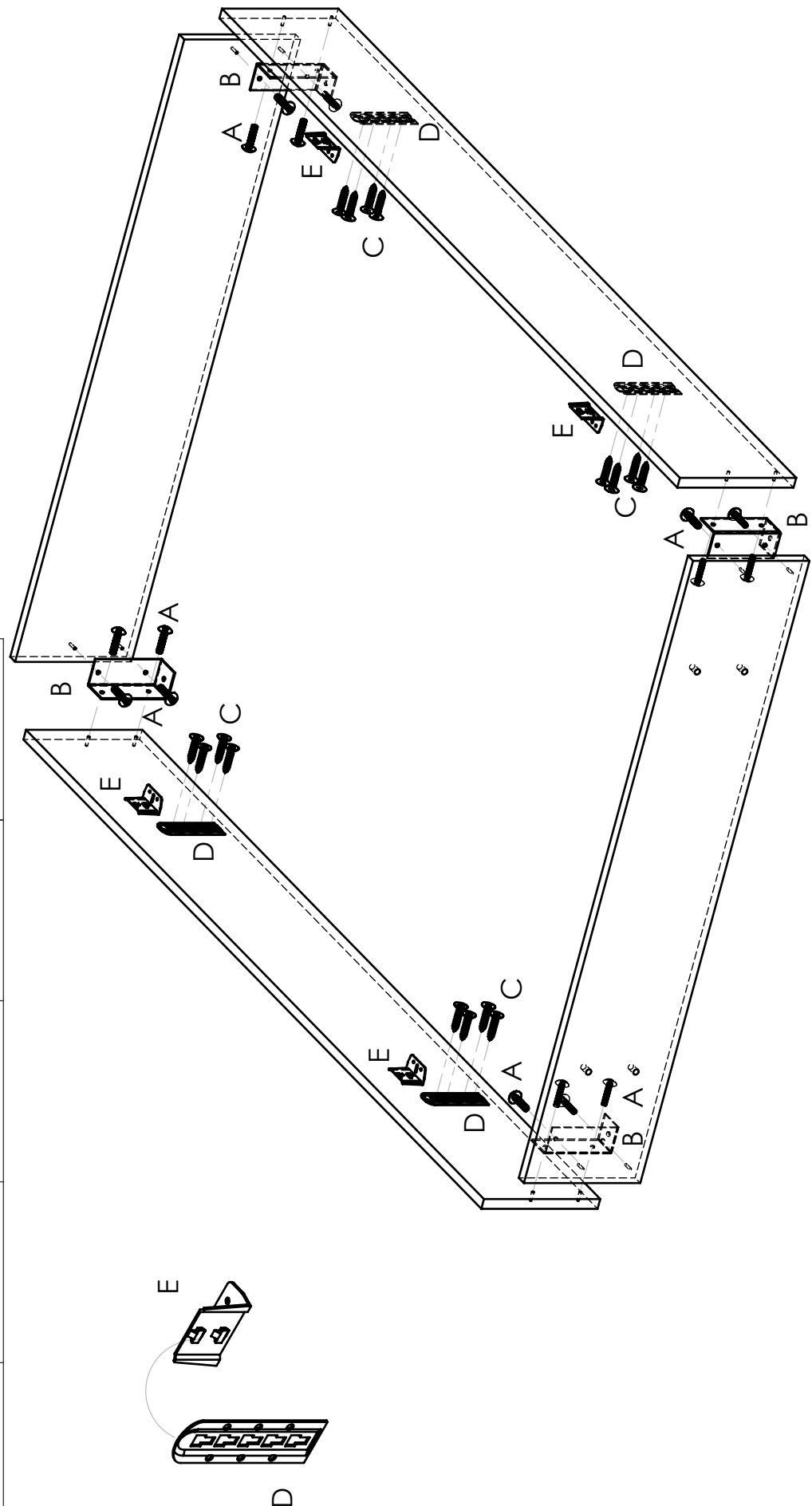
| | | | | | | | | | |
|---|---|----|---|------------|---|----|---|----|---|
| A |  | B |  | C |  | D |  | E |  |
| | 16x 6x25 | 4x | 4x | 16x 3,5x20 | 4x | 4x | 4x | 4x | 4x |

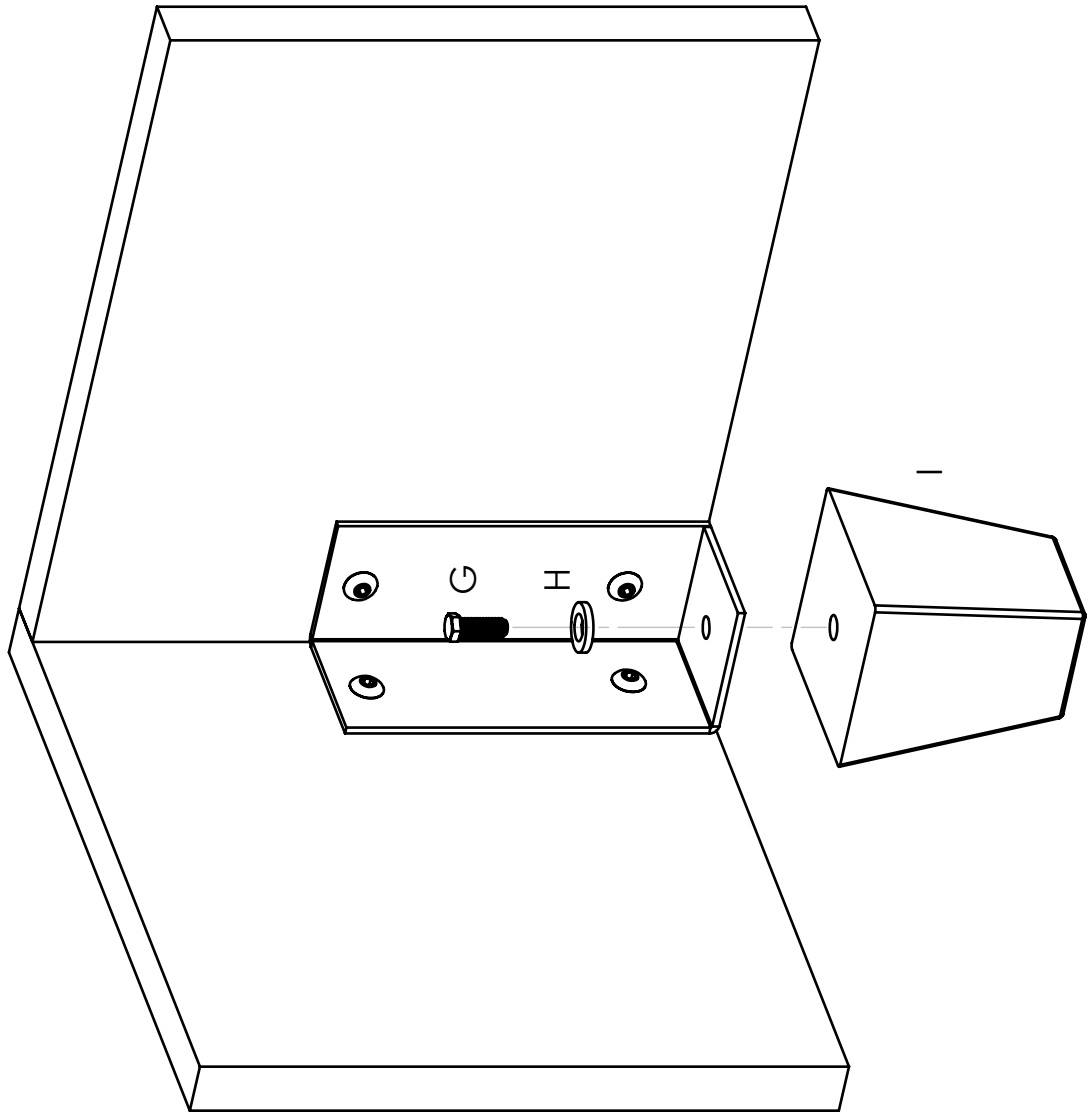

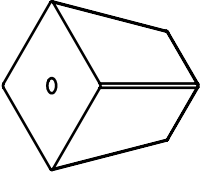
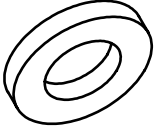



| | | |
|---|---|----------|
| I |  | 4x |
| H |  | 4x 8x20 |
| G |  | 4x M8x20 |

3.

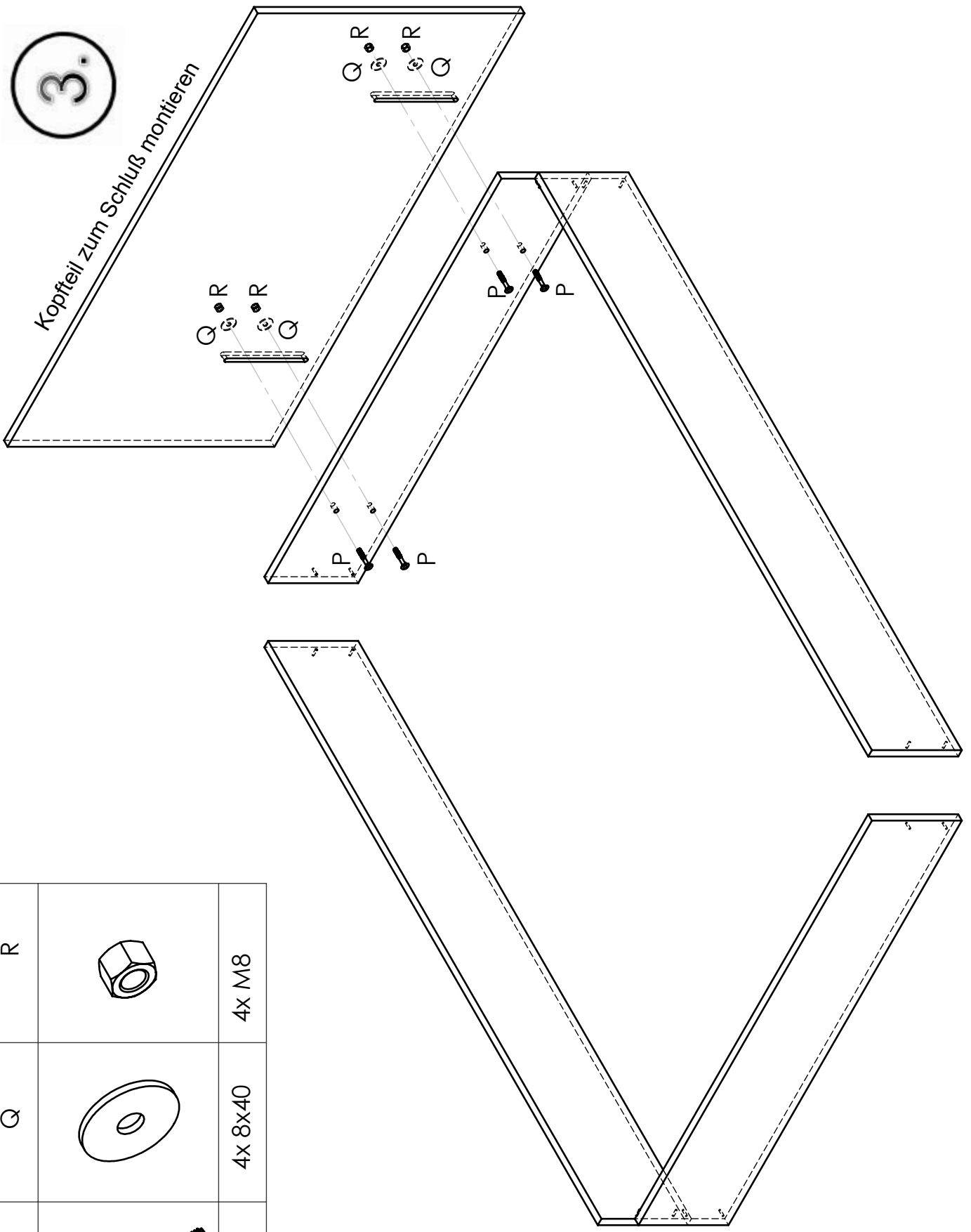
Kopfteil zum Schluß montieren

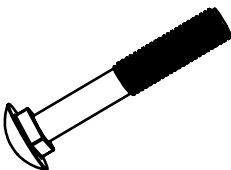
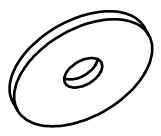

| | | |
|---|---|---------|
| P |  | 4x 8x60 |
| Q |  | 4x 8x40 |
| R |  | 4x M8 |