

BETRIEBS- ANLEITUNG

GALLERY

M



DUBAI

Nutzen Sie die Sicherheit einer großen Marke.



5 Jahre Garantie.

Auf GALLERY M Möbel ist Verlass.

Die Garantiebestimmungen, Gebrauchs- und Pflegeanweisungen sind im Gallery M Möbel-Gütepasse geregelt.

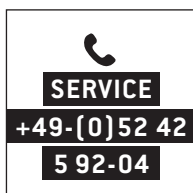
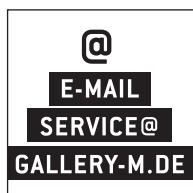

Service-Information

Sie erreichen uns per E-Mail oder über das Servicetelefon zu den üblichen Geschäftszeiten.



Individualität

Die GALLERY M Produktkennzeichnung belegt, dass Sie ein Unikat gekauft haben.



Pflege

Wir empfehlen GALLERY M Pflegeprodukte.

Lederpflege & Reinigung

Stoff-/ Mikrofaserpflege & Reinigung

Holzpflege und Sonderprodukte



Zu bestellen unter www.gallery-m-care.com
oder unter der kostenlosen Beratungsnummer
+ 49 (0) 800 / 88 88 885.

Bei Fragen sprechen Sie uns bitte an;
wir helfen Ihnen gerne weiter.

Zur Werterhaltung Ihrer Möbel

Unsere Pictogramme mit Erläuterungen

Aufbau

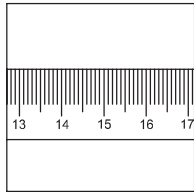

Maßangaben in den Preis- und Typenlisten beachten



Neu-/Umbauten sind vor der Lieferung abzuschließen

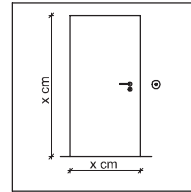

Stellflächen müssen eben und frei zugänglich sein

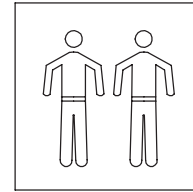

Lieferung und Montage nur durch Fachpersonal

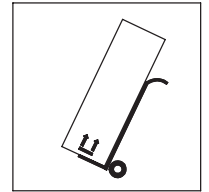

Verpackungsrichtlinien und Transporthinweise beachten

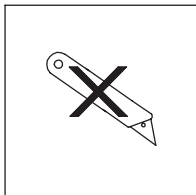

Nicht durch die Verpackung schneiden

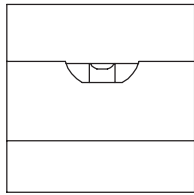

Genaueres Ausrichten mit der Wasserwaage erforderlich

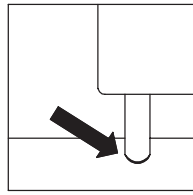

Möbelfüße/-gleiter sind den Fußböden anzupassen

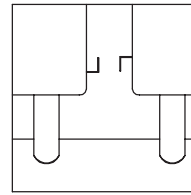

Elementverbindungen nach Herstellervorgaben

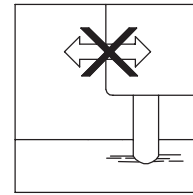

Montagezustand nicht ohne Demontage verändern

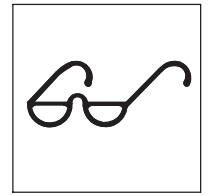

Abnahme durch Sicht- und Funktionsprüfung

Betrieb

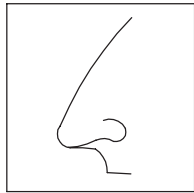

Neumöbelgeruch ist material- und warentypisch

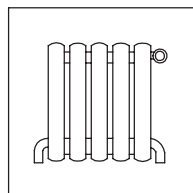

Mindestabstand zu Heizquellen beachten

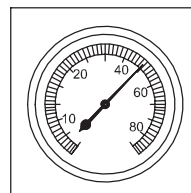

Empfohlenes Raumklima
Ø 45-55% Luftfeuchte

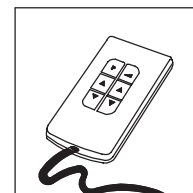

Betriebsanleitung beachten

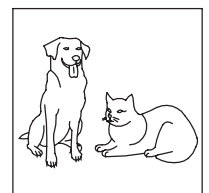

Haustiere schaden Bezügen bzw. Oberflächen

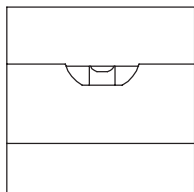

Genaueres Ausrichten mit der Wasserwaage erforderlich

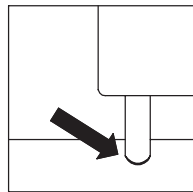

Möbelfüße/-gleiter sind den Fußböden anzupassen

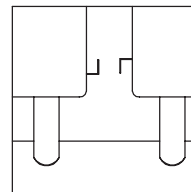

Elementverbindungen nach Herstellervorgaben

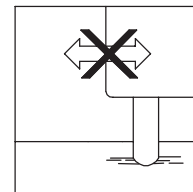

Montagezustand nicht ohne Demontage verändern

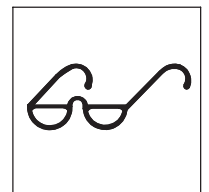

Abnahme durch Sicht- und Funktionsprüfung

Wartung

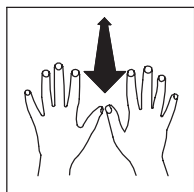

Polsterbezüge regelmäßig aufklöpfen

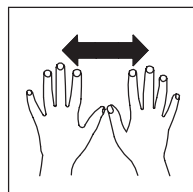

Polsterbezüge regelmäßig glätten

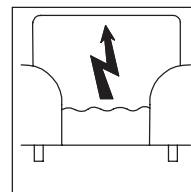

Statische Aufladung der Bezüge möglich

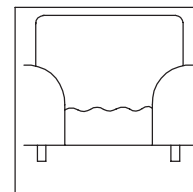

Legerer Polsteraufbau neigt zur Wellenbildung

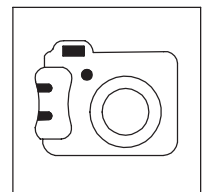

Im Schadenfall Foto: Gesamt-, Detailansicht

Betriebsanleitung

(Bitte aufbewahren)

Box-System Dubai / ~~Dubai XL~~ 160/180/200 x 200

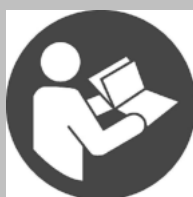

D Montageanleitung

GB Assembly instructions

NL Handleiding voor de montage

PL Instrukcja montażu

TR Montaj talimatı

RU ИНСТРУКЦИЯ ПО МОНТАЖУ

RO Instrucțiunile de instalare

I Istruzioni per l'installazione

F Instructions d'installation

SK Návod na inštaláciu

CZ Návod k instalaci

H Telepítési utasítások

28403457

020120190

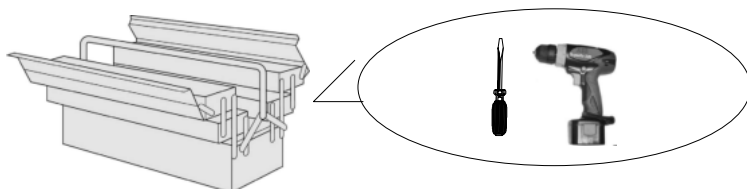
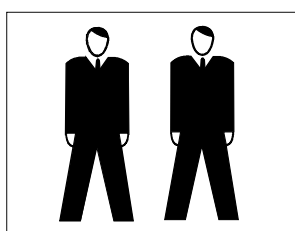

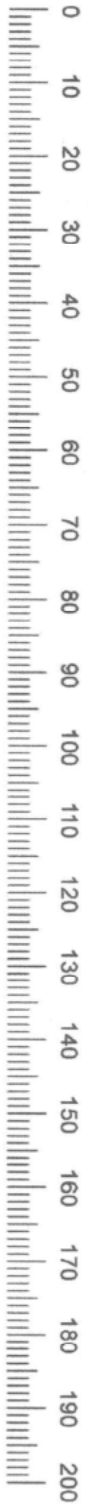

Service • Dienstverlening • Serwis • Servis • Сервисная служба

Name • Naam • Nazwa • Isim • Название Box-System Dubai	
Nr. • No. • Номер	
Тур • Type • Тип • Тип	
Boxspring 160/180/200 x200	

Beschlagkarton Chromfuß (Fuß 1)

A	2x	B	2x	C	2x	D	2x
				M8x25		M8x60	
E	1x	F	4x	G	2x	H	2x
				4x70		6,4	
						I	4x
						5x40	

Beschlagkarton Chromkufe / Fuß 2

A	2x	B	2x	C	2x	D	1x
		M8x25		M8x60			
E	4x	F	2x	G	2x	H	2x
		4x70		6,4		8,4	



DUBAI

Beschlagkarton XL
(nur eine Seite)

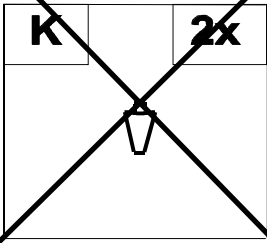

Beschlagkarton XL
(beide Seiten)

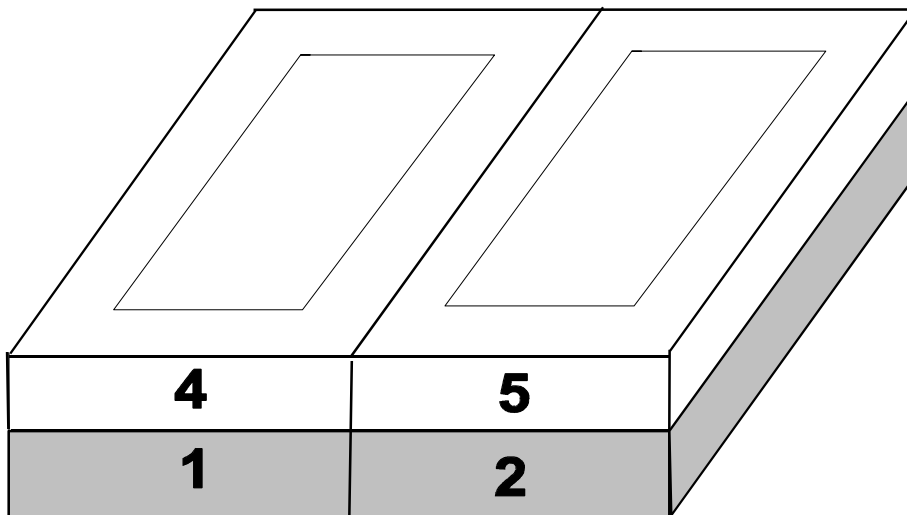
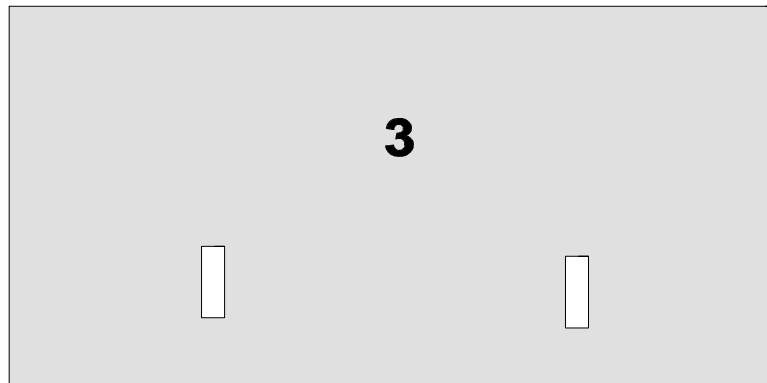
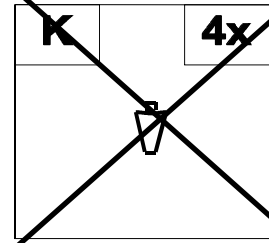

DUBAI

Teil I

1. Fuß 1

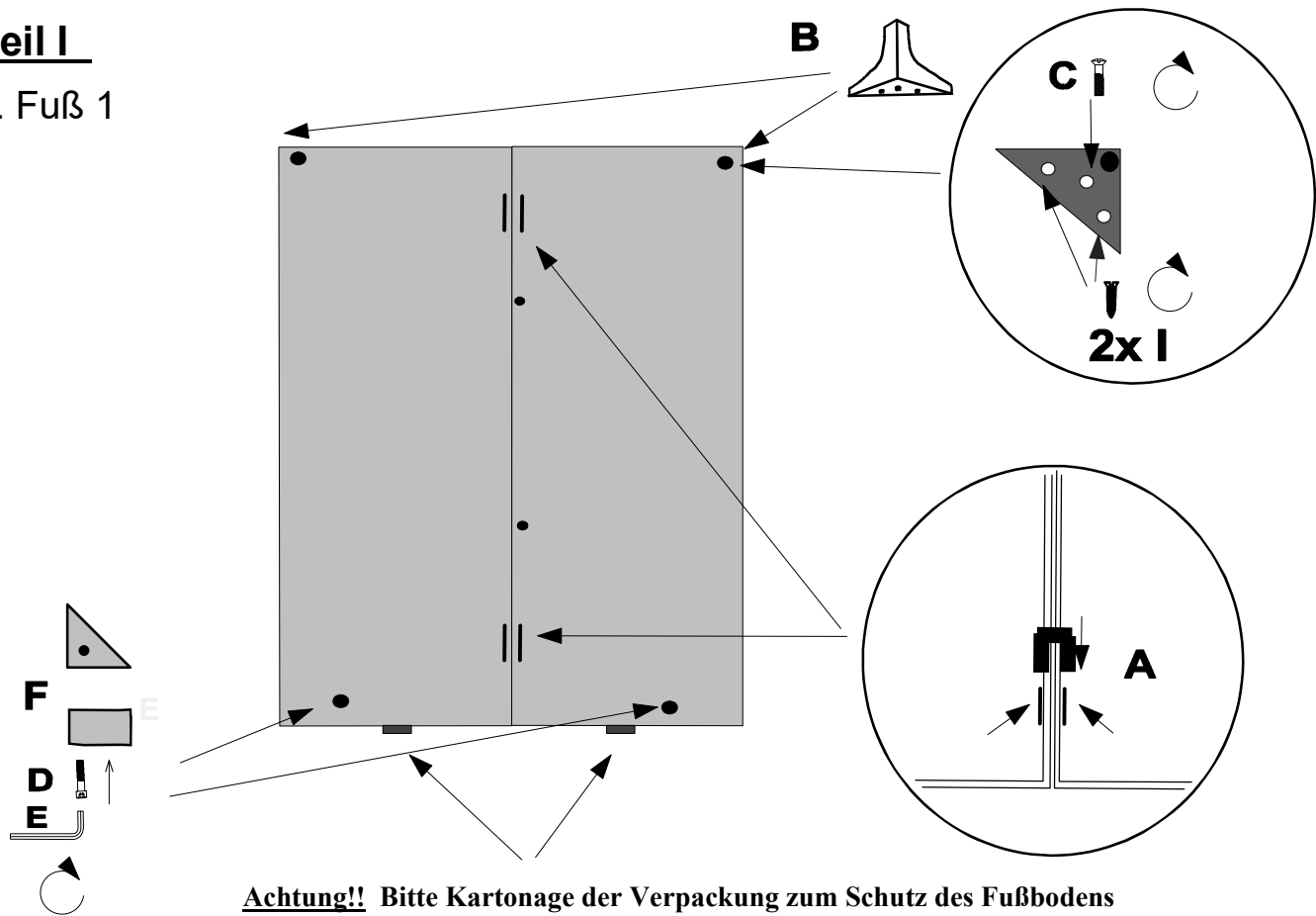

1. Fuß 2 / Kufe

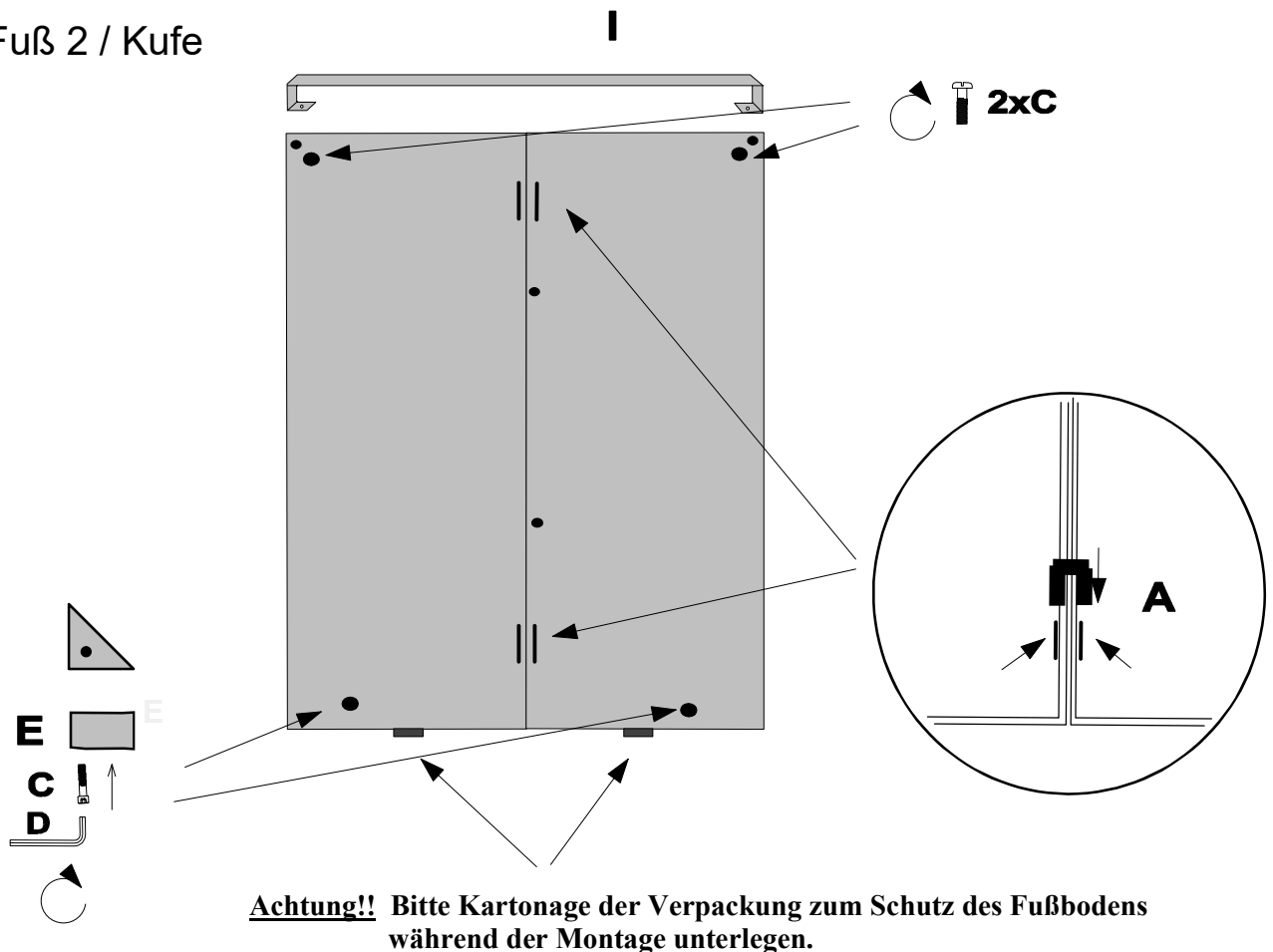

2.

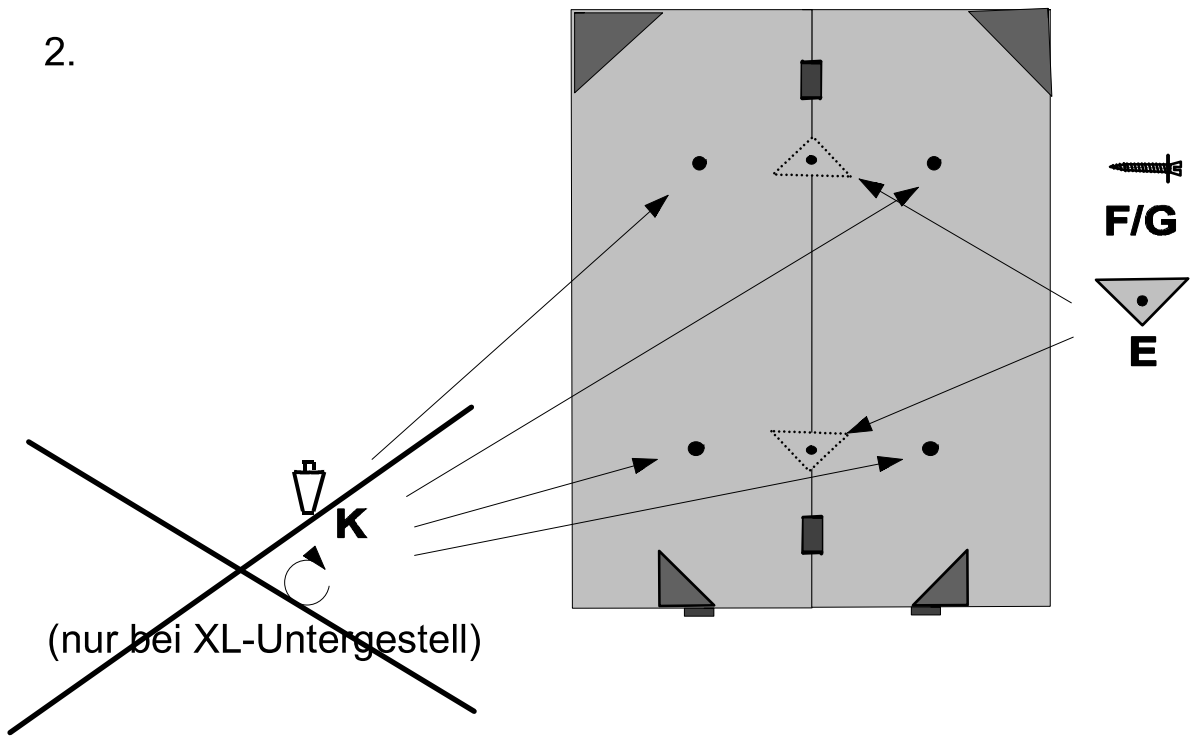

3. Kopfteilmontage

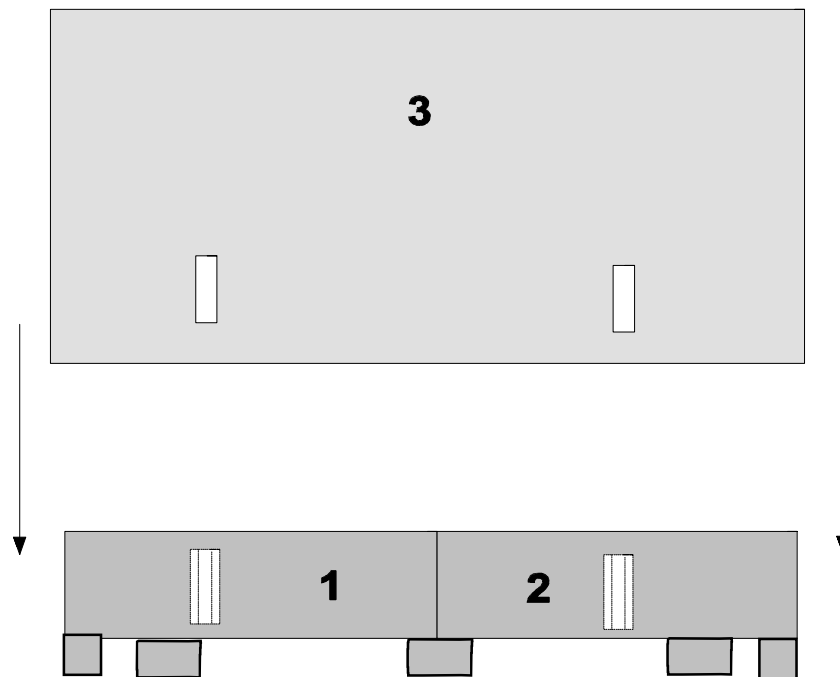

Kopfteil in entsprechende Halterungen an den Bettkästen einhängen, dabei Bettkästen am Kopfende leicht zusammendrücken, anschließend Matratzen auflegen.

4. Matratzen auflegen

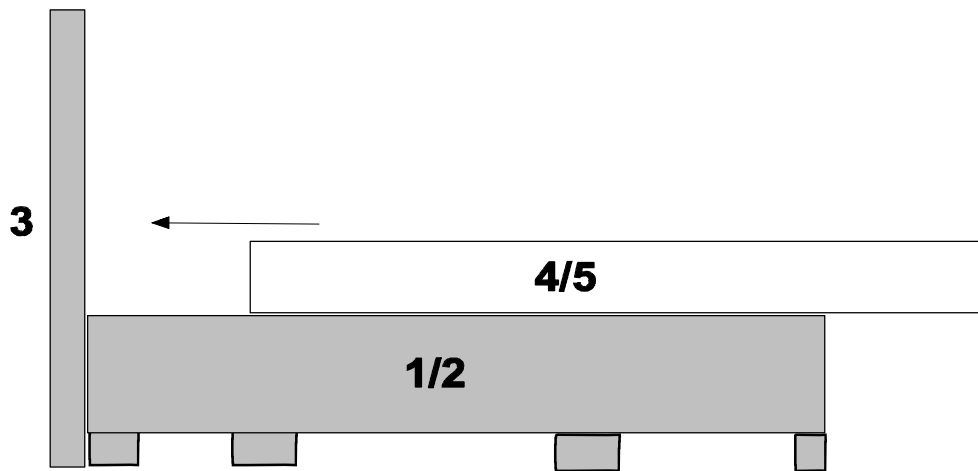

Montageanleitung

(Bitte aufbewahren)

Beleuchtungsset für Kopfteilrückseite



- HFH 100-0593
- HFH 100-0594
- HFH 100-0595
- HFH 100-0596
- HFH 100-0597
- HFH 100-0598

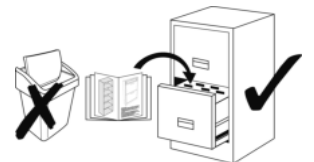
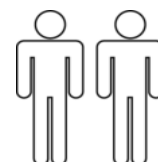
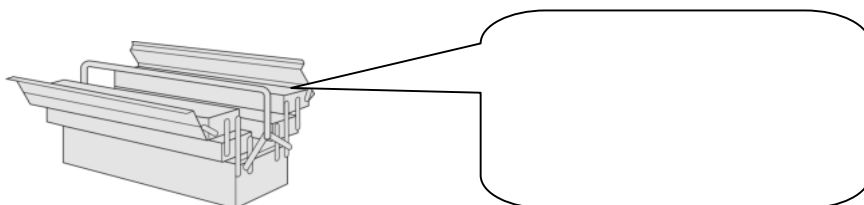
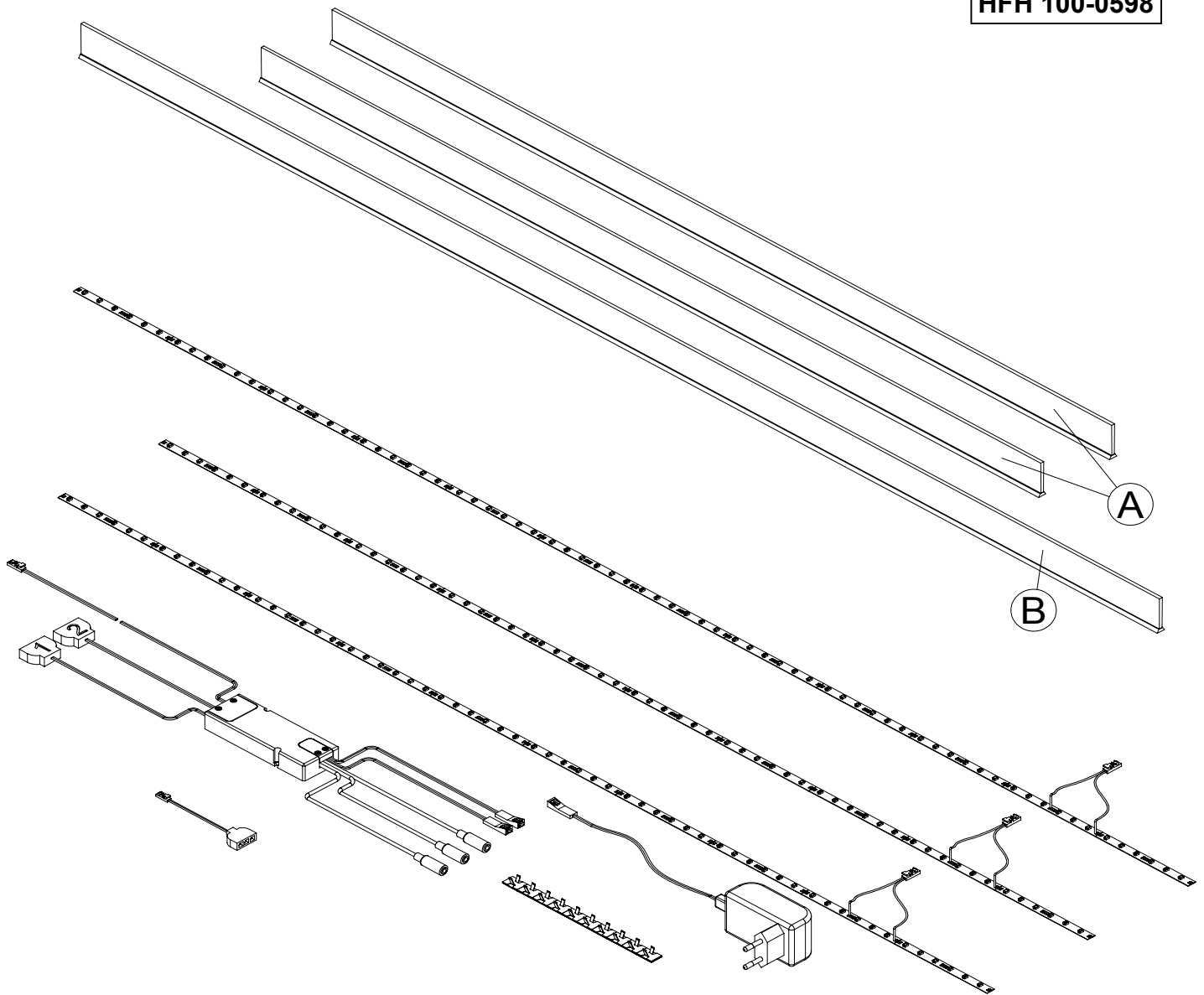



Nicht die Schutzfolie vom Klebeband entfernen
Do not remove protective foil from the adhesive tape

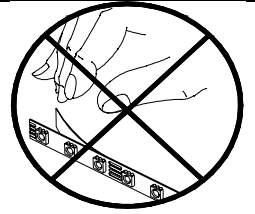

Nicht knicken!
Do not bend!

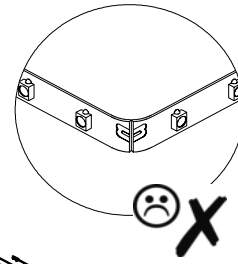

Kabel durch die Bürsten führen.
Place cable through the brushes.

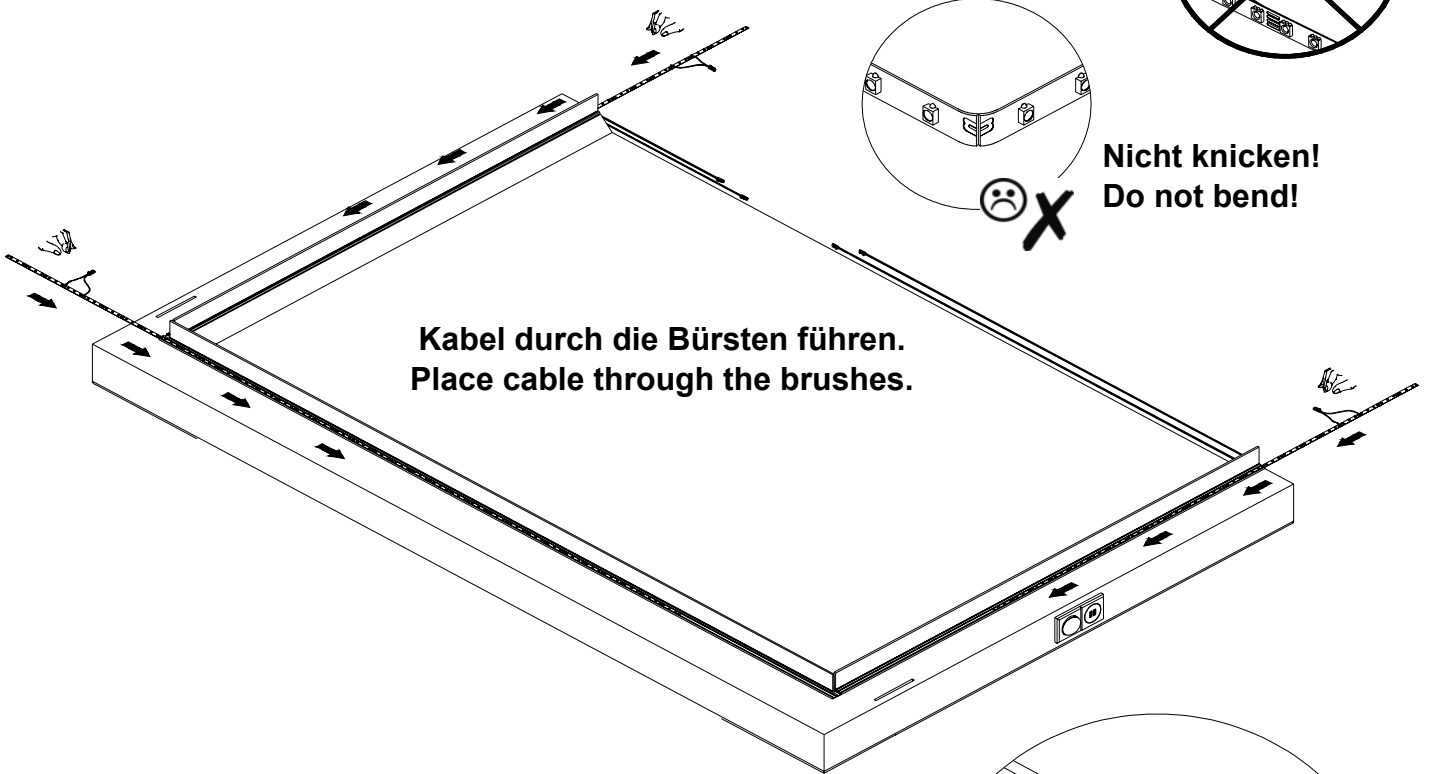

Bänder vorsichtig in das Profil einschieben.
Carefully slide the LED-strips into the profile.

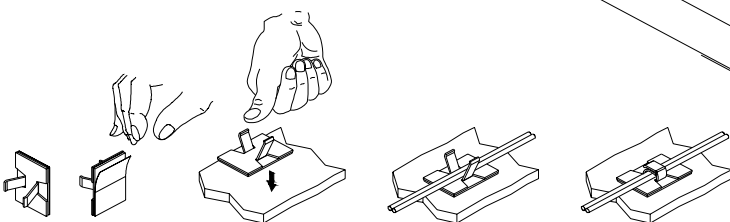
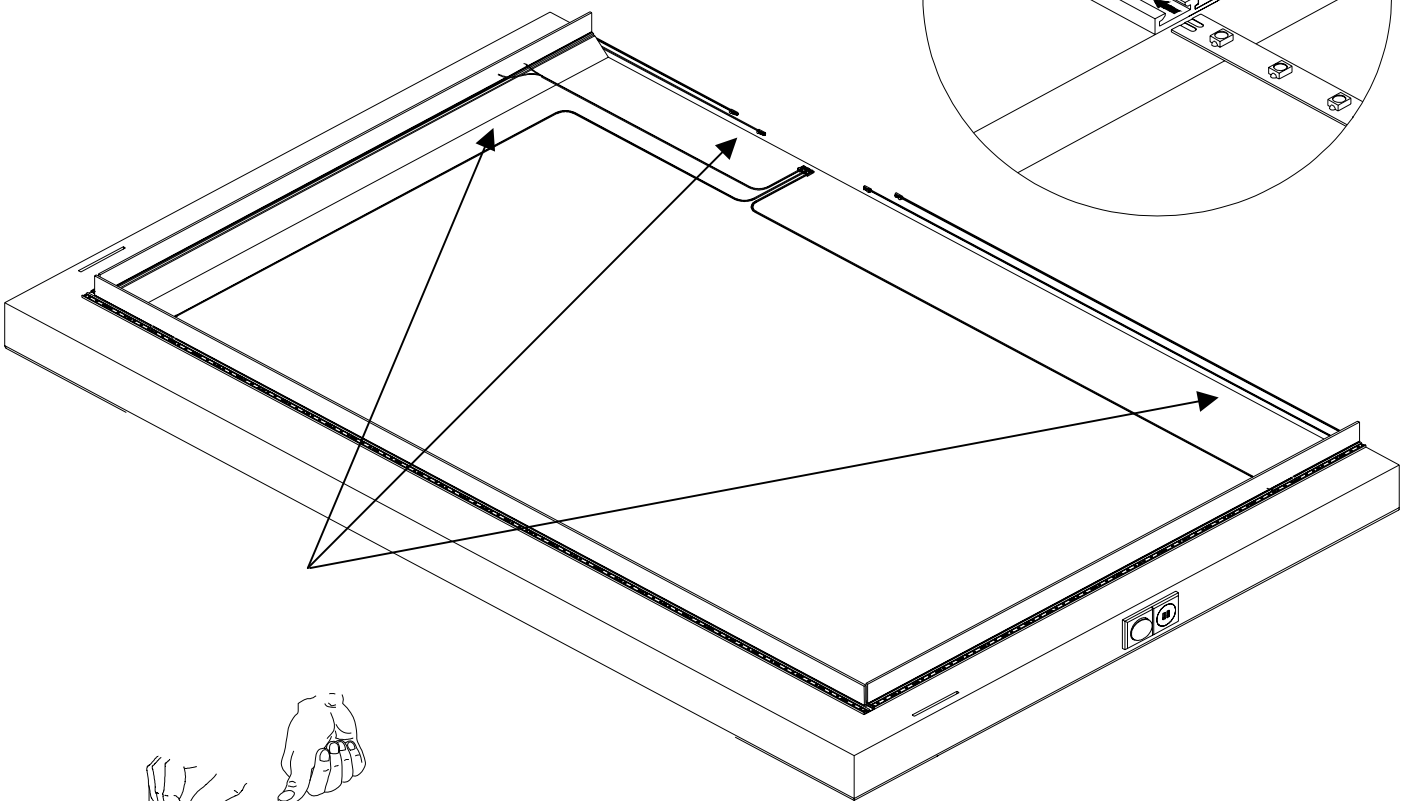
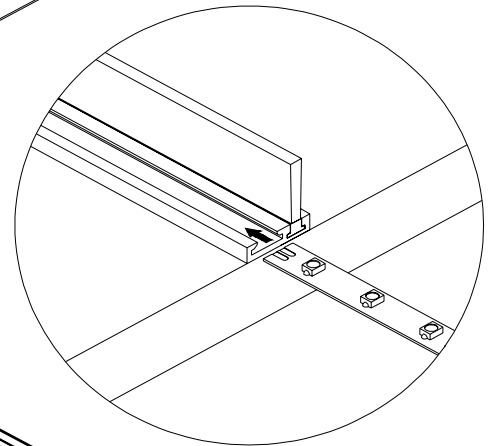

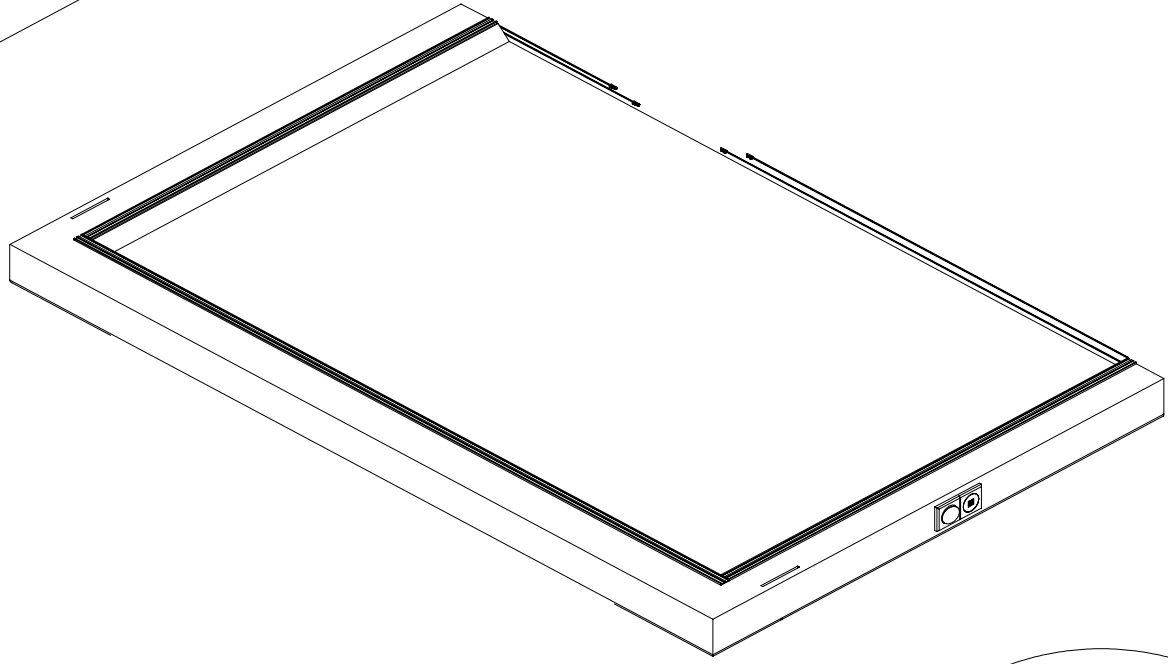
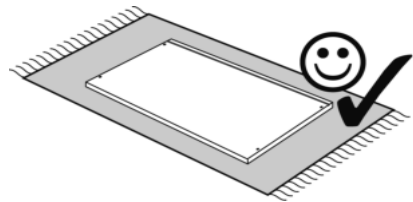
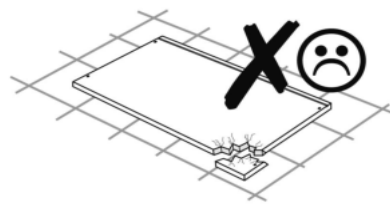
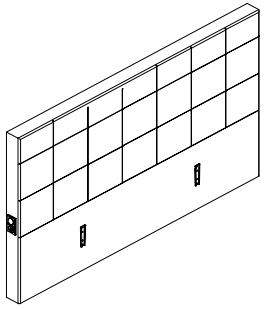

**Bürste in inneres Profil einschieben:
Slide brush into the inner profile:**

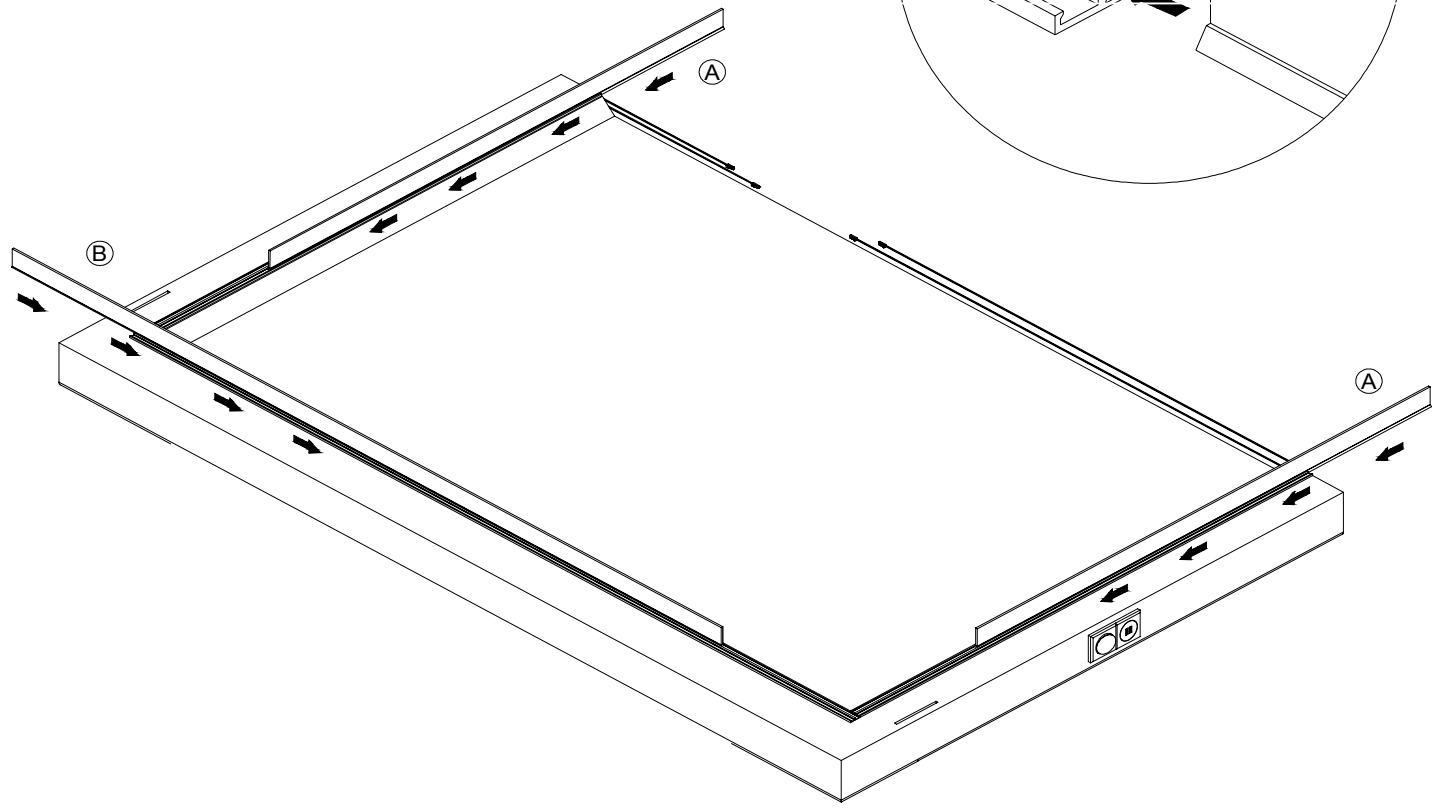
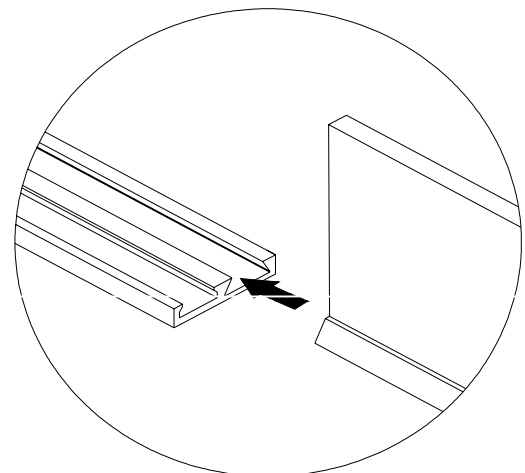

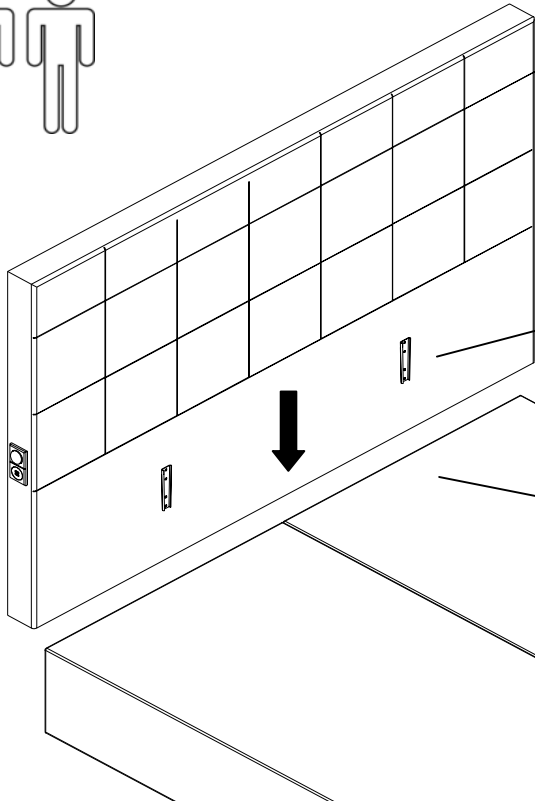

**Kopfteilmontage:
Bedhead mounting:**

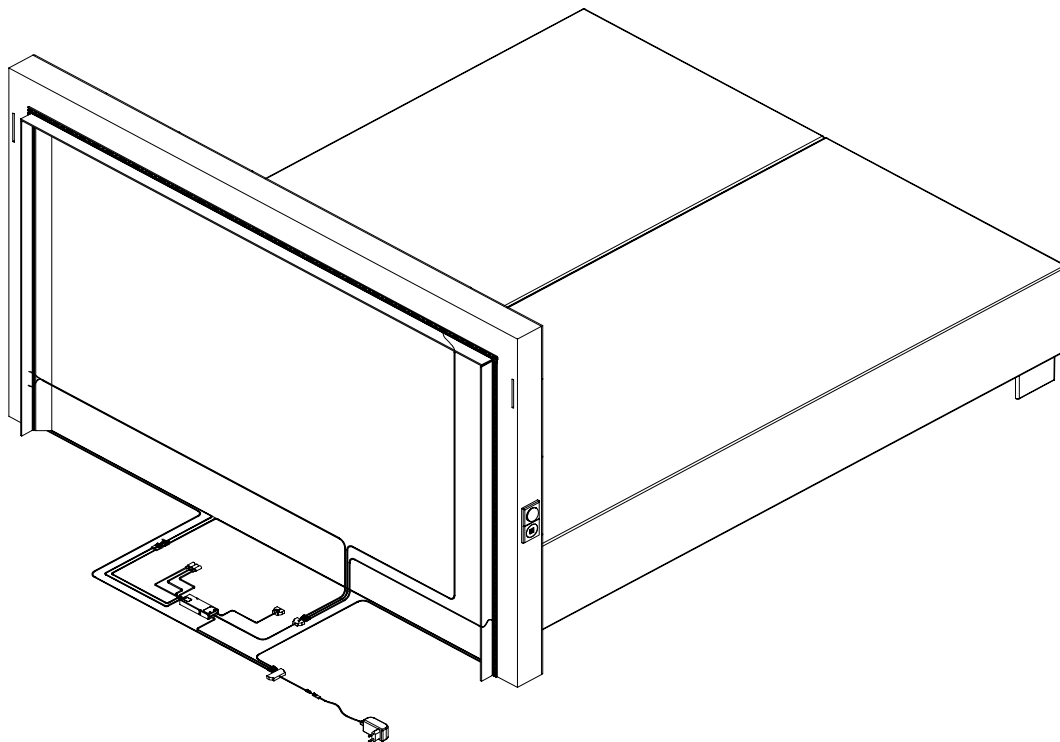
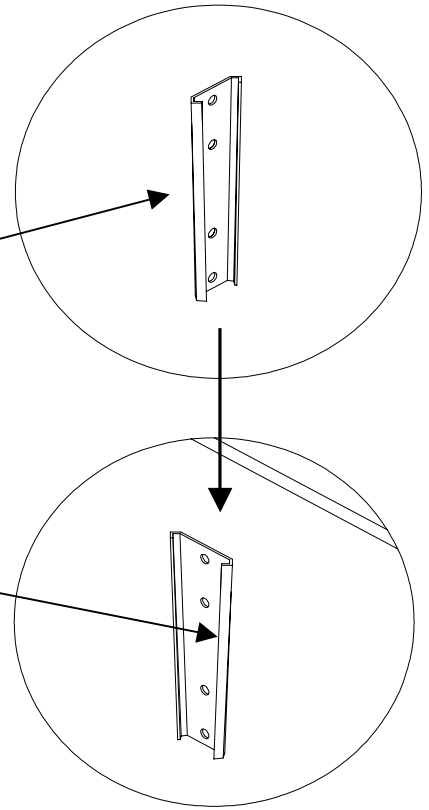

Anschluß der Kopfteilbeleuchtung:
connection of the bedhead illumination:

Trafo

USB links

Beleuchtung Kopfteil

2

PIR

Schalter links

Schalter rechts

USB rechts

Verwendung der Lichtsteuerung:**Use of the light control :**

- 1: Taste kurz drücken, Beleuchtung wird eingeschaltet
- 2: Taste kurz drücken, Beleuchtung wird ausgeschaltet

- 1: Short press on the key, the lighting is switched on
- 2: Short press on the key, the lighting is switched off

