

P185 / P208

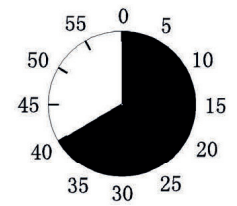

1

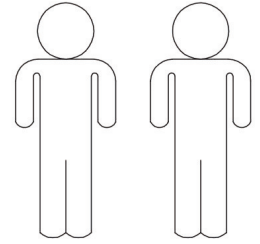
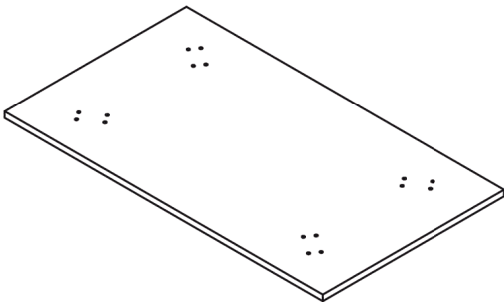

2.1

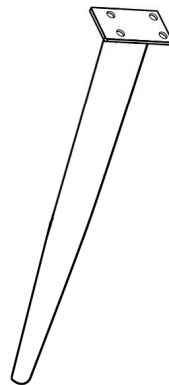

2.2

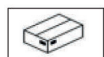
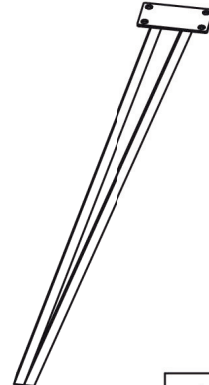

1	1x	1/2
2	4x	2/2

A

M8*12



16X

B

M8*16



16X

C

Ø18*Ø8*1.5



16X

D

Ø25



4X

E

5mm



1X

F



8mm



1X

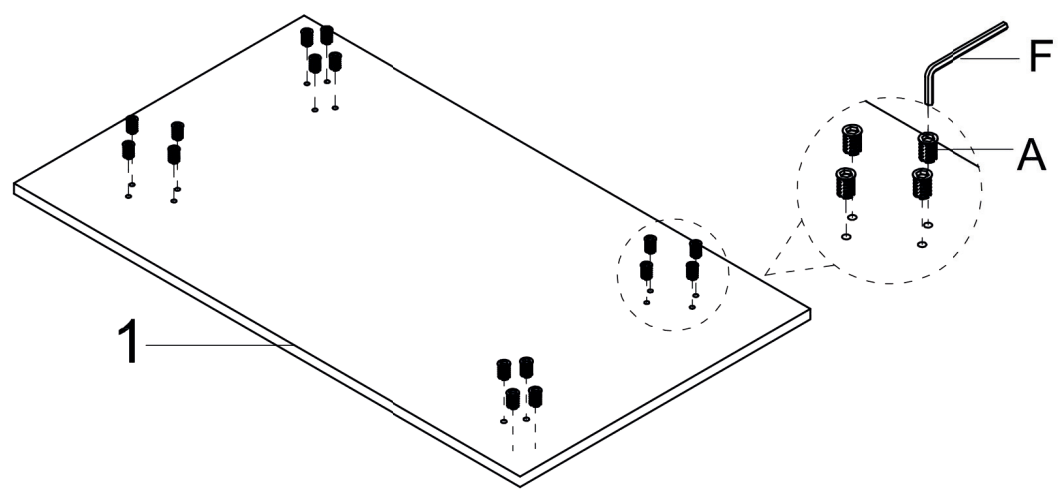



I.
1.

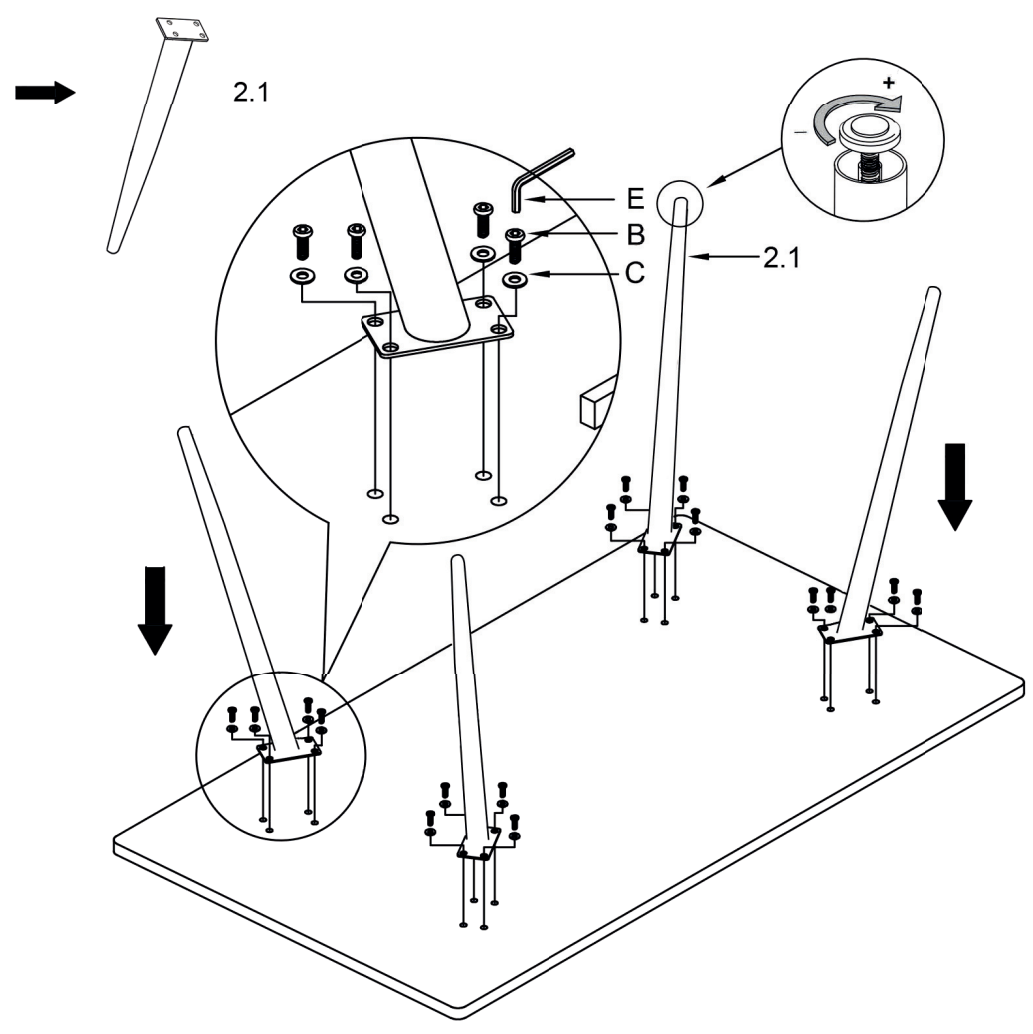

A	 M8*12 16X
F	 8mm 1X
	

2.1

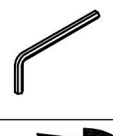

B	 M8*16 16X
C	 Ø18*Ø8*1.5 16X
E	 5mm 1X
	

1.
2.2

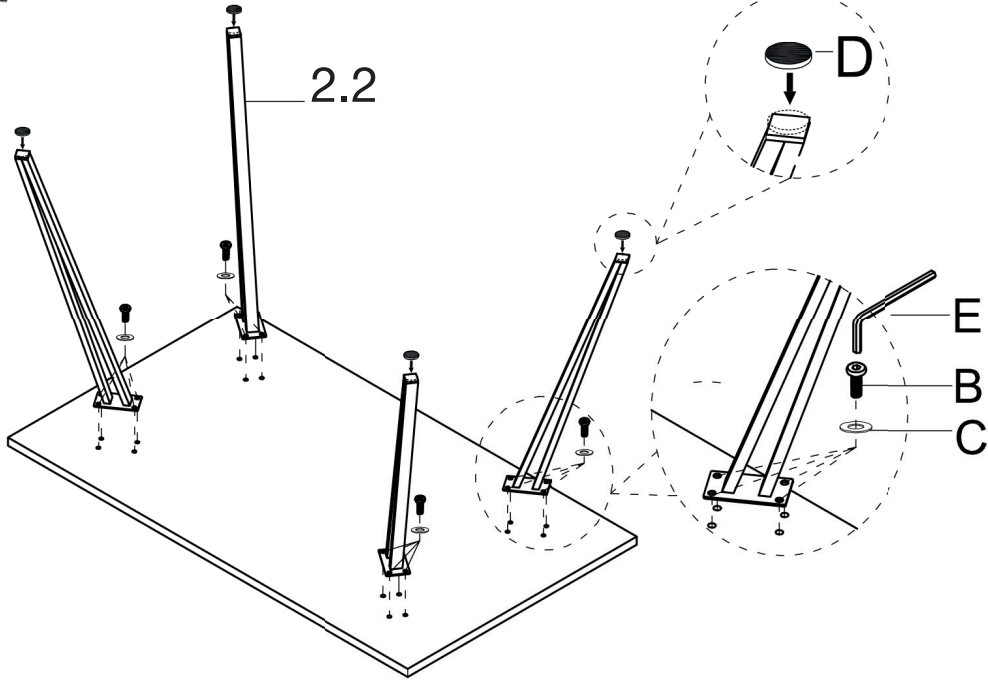
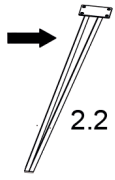

B	M8*16 16X
C	Ø18*Ø8*1.5 16X
D	Ø25 4X
E	5mm 1X

3.

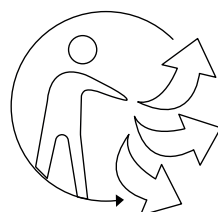
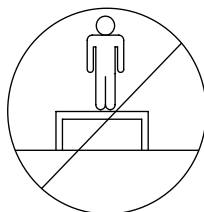
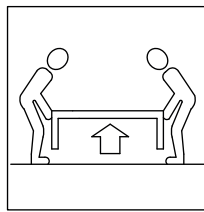
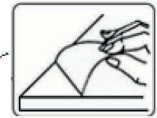
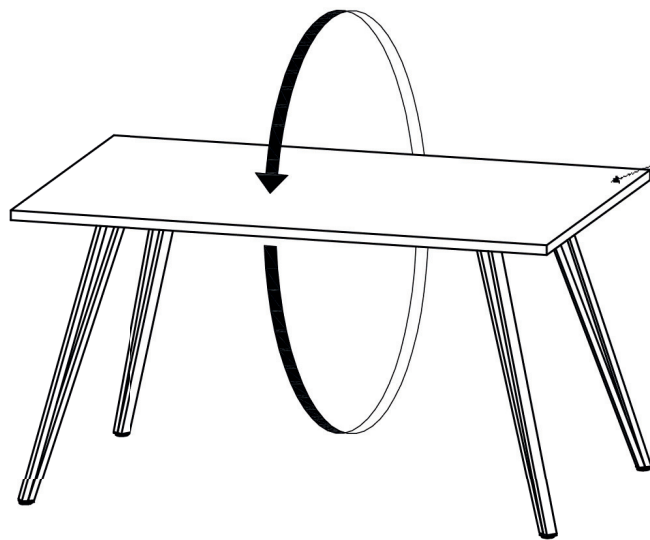
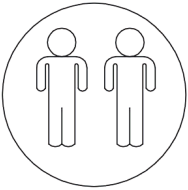

Tina 1

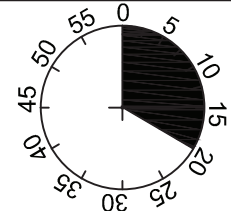
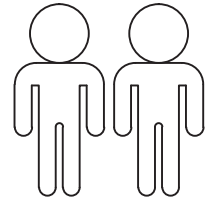
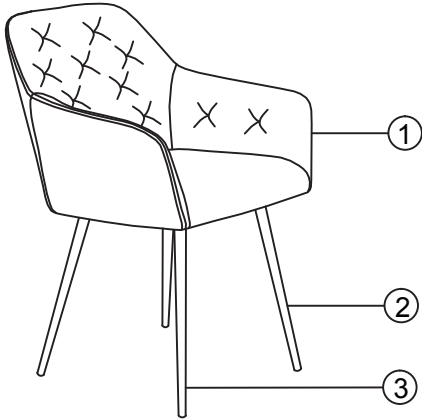

1

2

3

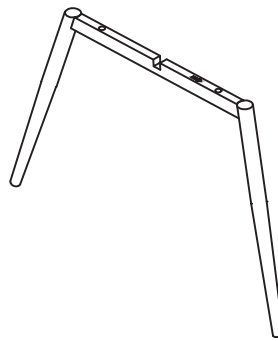
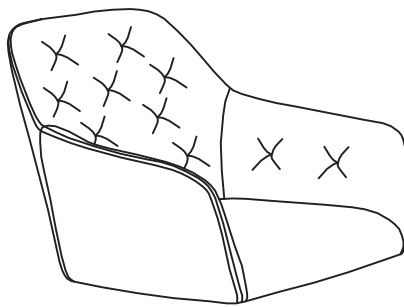



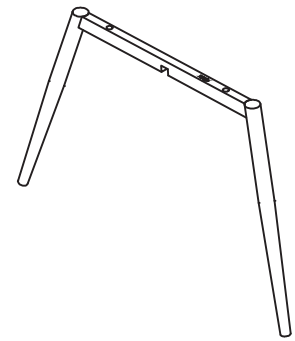

R

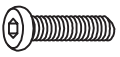

L

1	1 x
2	1 x
3	1 x

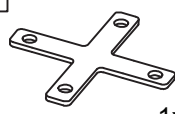
A	M6X40	B	M6x13	C	Ø14xØ6x1.5	D	4MM	E	T2.0x90x90
									
	4x		4x		4x		1x		1x

I.

1

3 → L

1 →

D

A

C

A M6x40
2x

C Ø14xØ6x1.5
2x

D 4MM
1x

75%

2

2 → R

D

A

C

A M6x40
2x

C Ø14xØ6x1.5
2x

D 4MM
1x

75%

3

D

B

E

B M6x13
4x

D 4MM
1x

E T2.0x90x90
1x

75%

4

D

4MM

1x

100%

