

# Lina

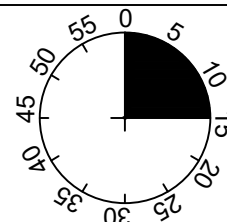

1

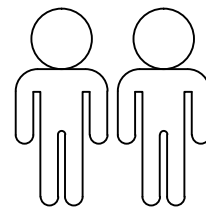
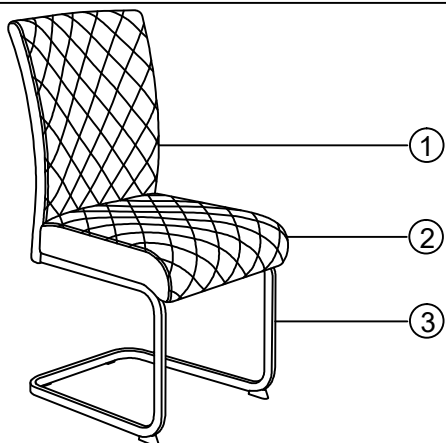
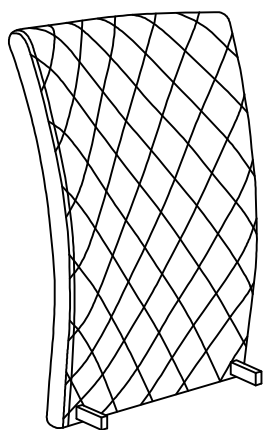

2

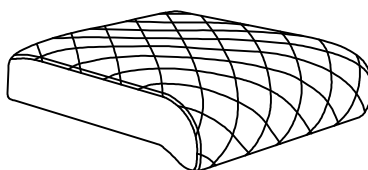

3

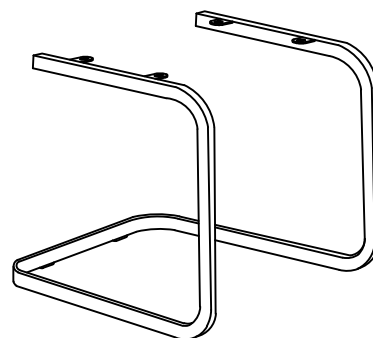

1	1x
2	1x
3	1x

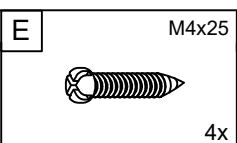
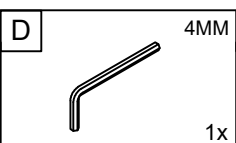
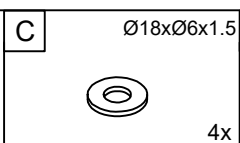
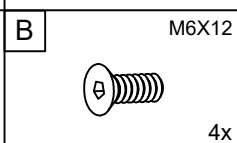
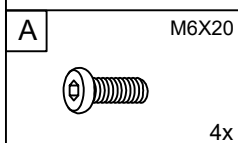
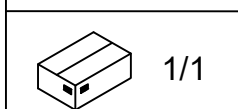

**I.**

**1**

E M4x25 4x

F 2x

100%

**2**

B M6x12 4x

D 4MM 1x

75%

**3**

A M6x20 4x

C Ø18xØ6x1.5 4x

D 4MM 1x

75%

**4**

D 4MM 1x

100%



**LE TRI + FACILE**



Séparez les éléments avant de trier