

# NORDIC

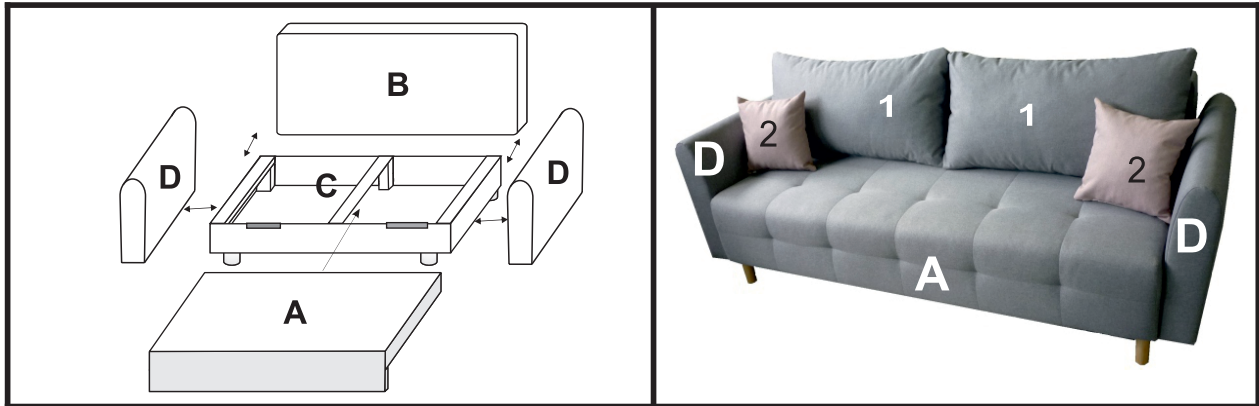

- (DE) Montageanleitung
- (IT) Istruzioni di montaggio
- (PL) Instrukcja montażu
- (FR) Notice de montage
- (NL) Handleiding voor de montage
- (RO) Instrucțiuni de asamblare
- (GB) Assembly instructions
- (SK) Montážny návod
- (TR) Montaj talimatı
- (CZ) Montážní návod
- (RU) Инструкция по монтажу
- (HU) Szerelési útmutató



9 x (4x16)  a	4 x M8 x 70  b	4 x Ø8  c	4 x M8  d	4 x (5x35)  e	4 x  X 25mm 50mm	4 x  y	4 x  z
2 x  W 13 cm						2 x  1	2 x  2

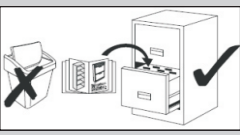
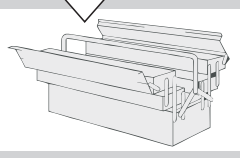
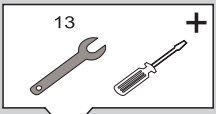
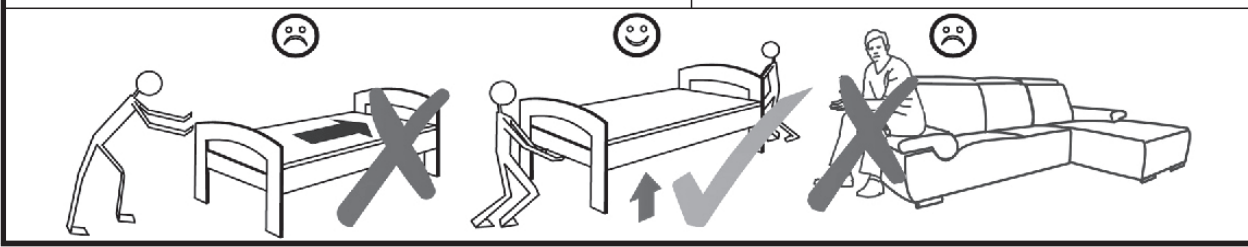
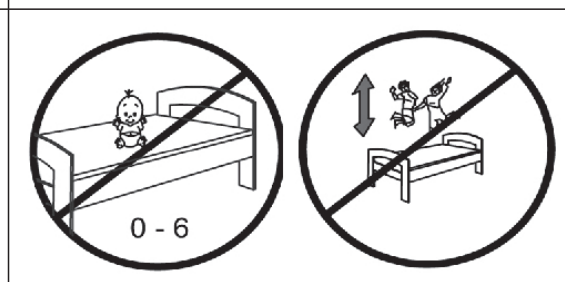
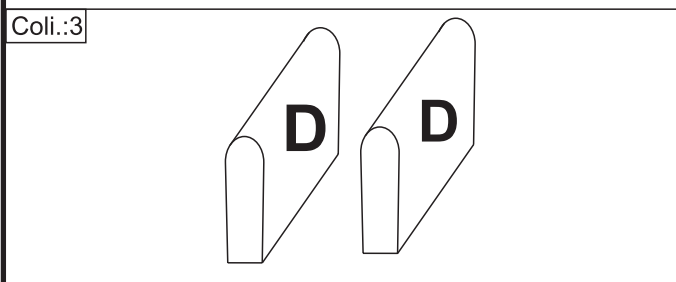
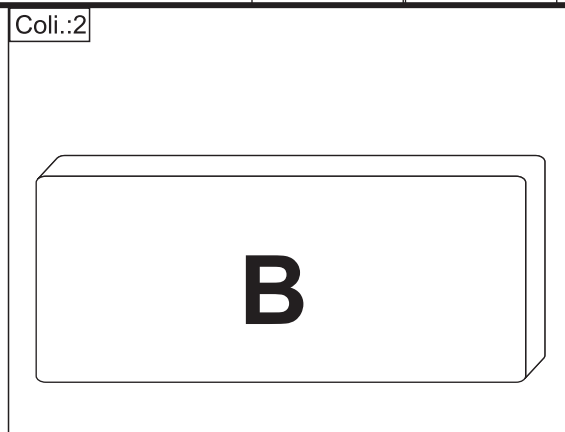
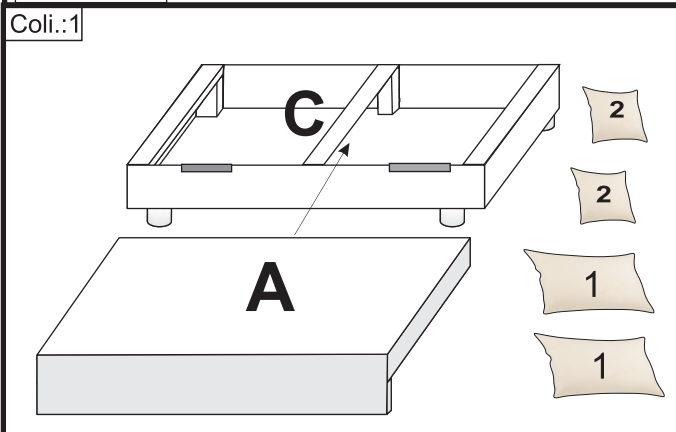

1

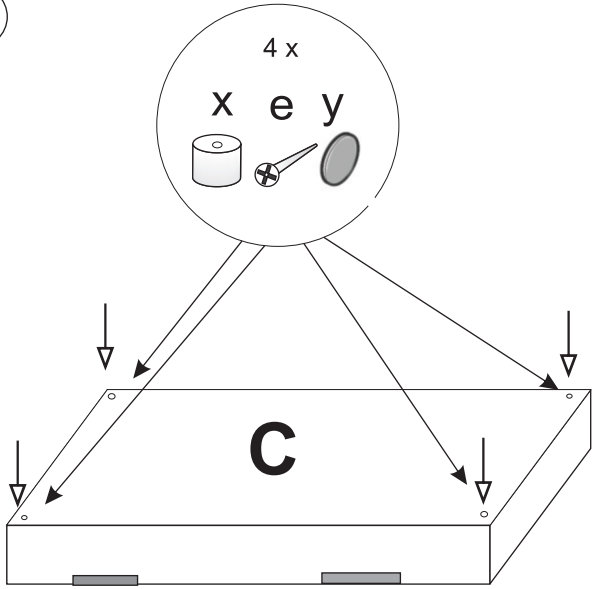

2

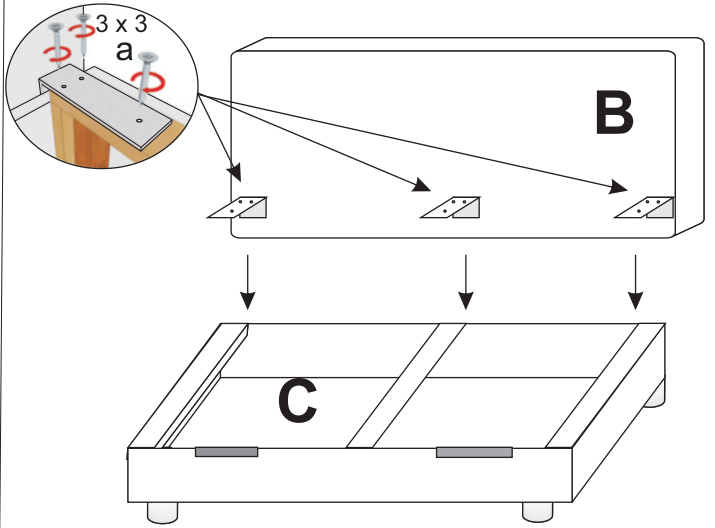

4

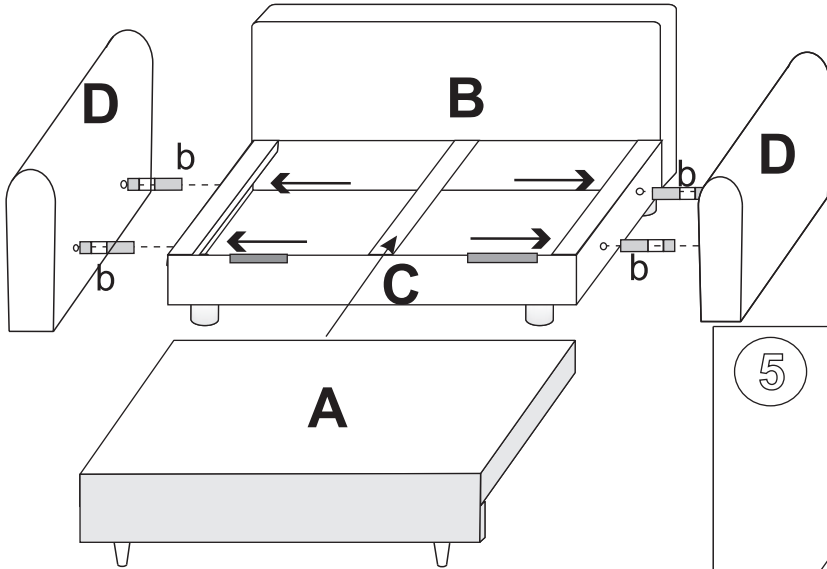
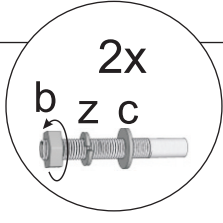
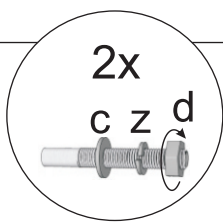

3

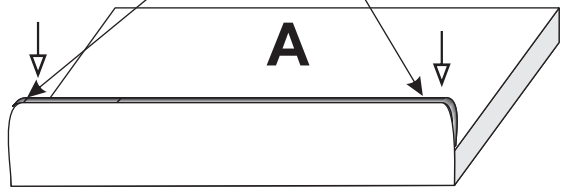
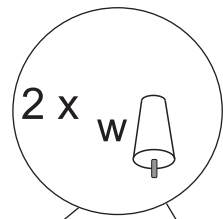

5

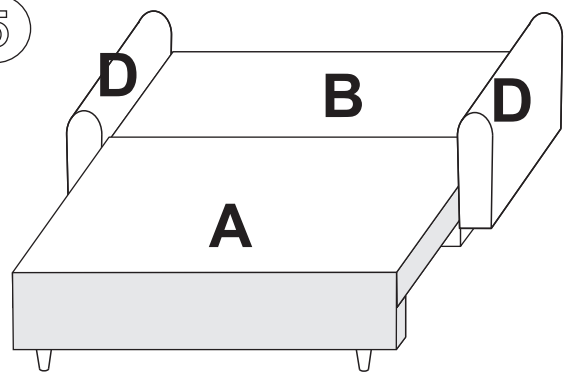

6

