

VALANTINE,
ALCUDIA, ALCATRAZ
8241-0086/3000-0086/8300-0086
8100-0086/3000-0086/8242-0086

- | | | | |
|-----------|--|-----------|---|
| D | MONTAGEANLEITUNG
BEDIENUNGSANLEITUNG | GB | ASSEMBLY INSTRUCTIONS
INSTRUCTION MANUAL |
| NL | HANDLEIDING VOOR DE MONTAGE
GEBRUIKSAANWIJZING | PL | INSTRUKCJA MONTAŻU
INSTRUKCJA OBSŁUGI |
| TR | MONTAJ TALIMATI
KULLANIM KLAVUZU | RU | ИНСТРУКЦИЯ ПО МОНТАЖУ
ИНСТРУКЦИЯ ПО ЭКСПЛУАТАЦИИ |
| RO | INSTRUCȚIUNI DE INSTALARE
INSTRUCȚIUNI DE UTILIZARE | IT | ISTRUZIONI DI MONTAGGIO
MANUALE DI ISTRUZIONI |
| FR | NOTICE DE MONTAGE
MANUEL INSTRUCTIONS | SK | MONTÁŽNY NÁVOD
NÁVOD NA POUŽITIE |
| HU | KÖZGYŰLÉS UTASÍTÁSOK
KEZELÉSI UTASÍTÁS | CZ | MONTÁŽNÍ NÁVOD
NÁVOD K POUŽITÍ |
| SI | NAVODILA ZA MONTAŽO
NAVODILA ZA UPORABO | PT | INSTRUÇÕES DE MONTAGEM
MANUAL DO USUÁRIO |
| ES | INSTRUCCIONES DE MONTAJE
MANUAL DEL USUARIO | HR | UPUTE ZA MONTAŽU
UPUTE ZA UPOTREBU |

F/B

240624

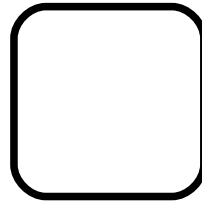
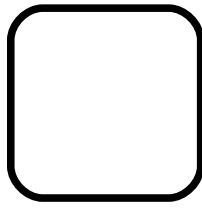

0019

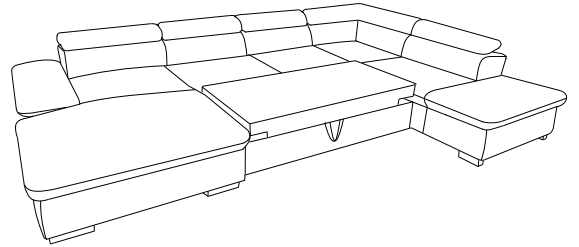
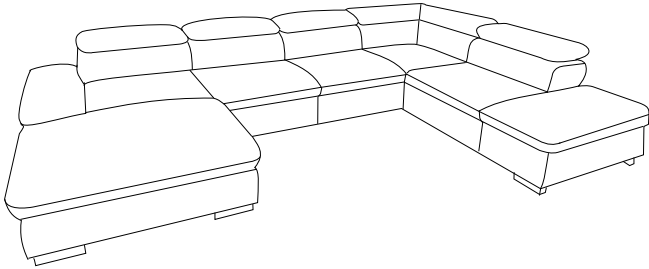

0019

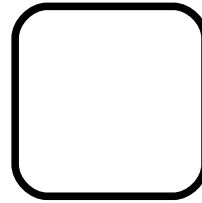
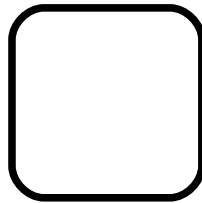



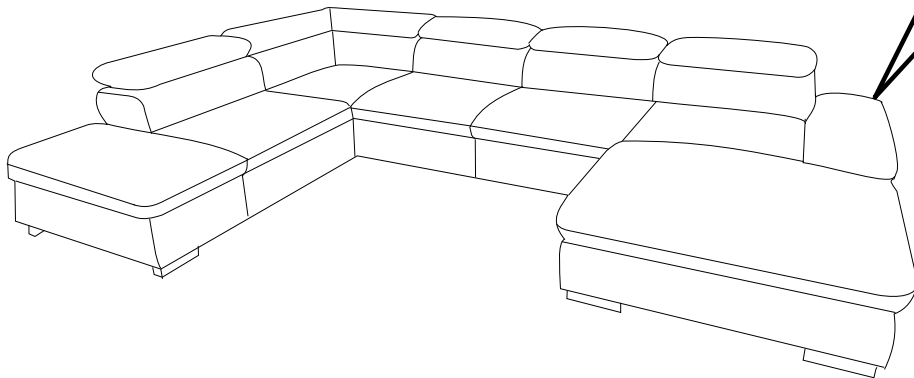
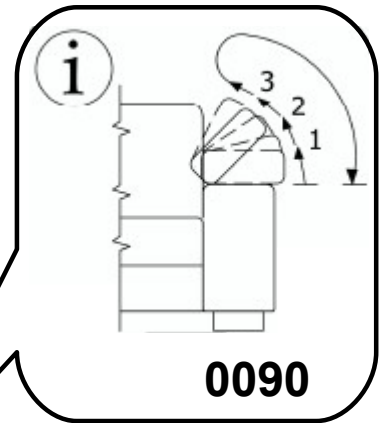



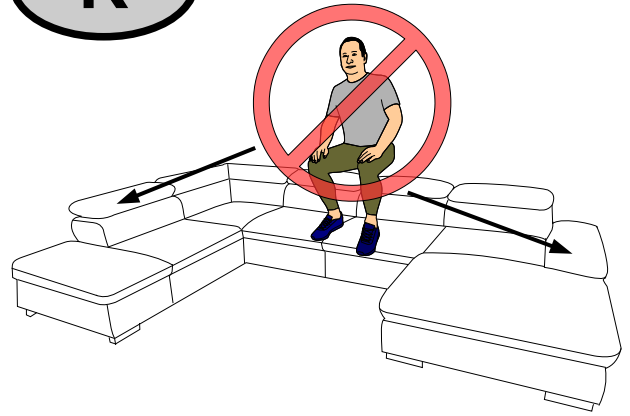
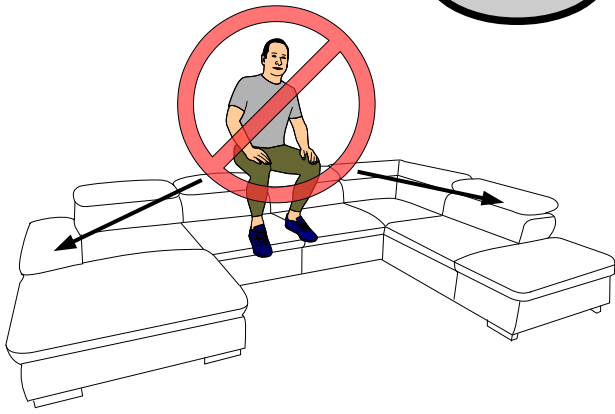

0090









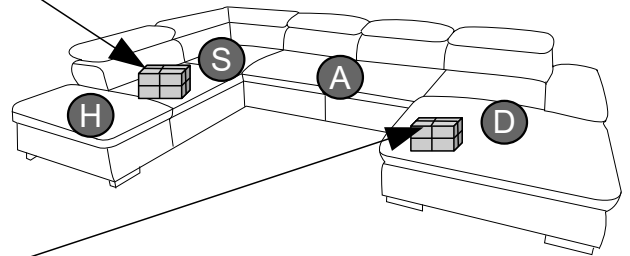
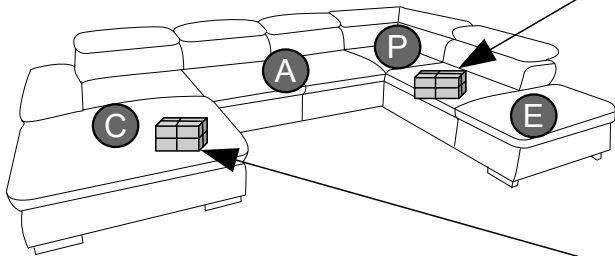

L

R



g H-50  X 1	z H-50  X 2	s H-40  X 1	d M5*50  X 4	x Fi-35  X 4	v H-50  X 1	h M5*30  X 4	v₁ Fi-20  10x40 X 2
---	---	---	--	--	--	--	---





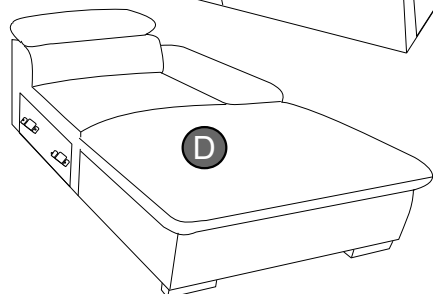
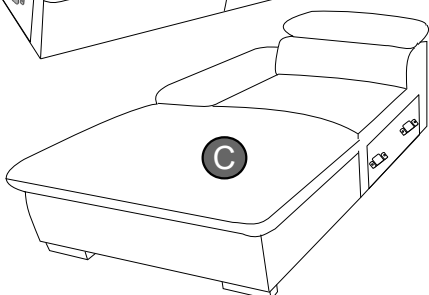
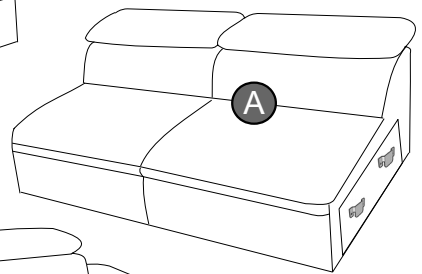
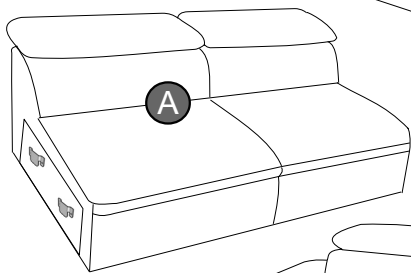
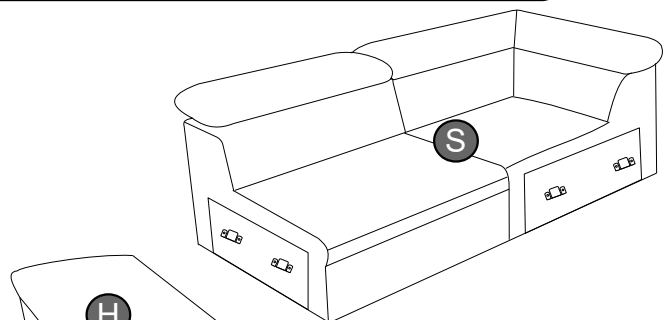
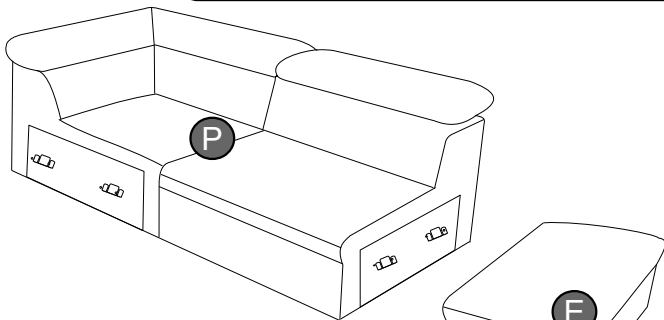

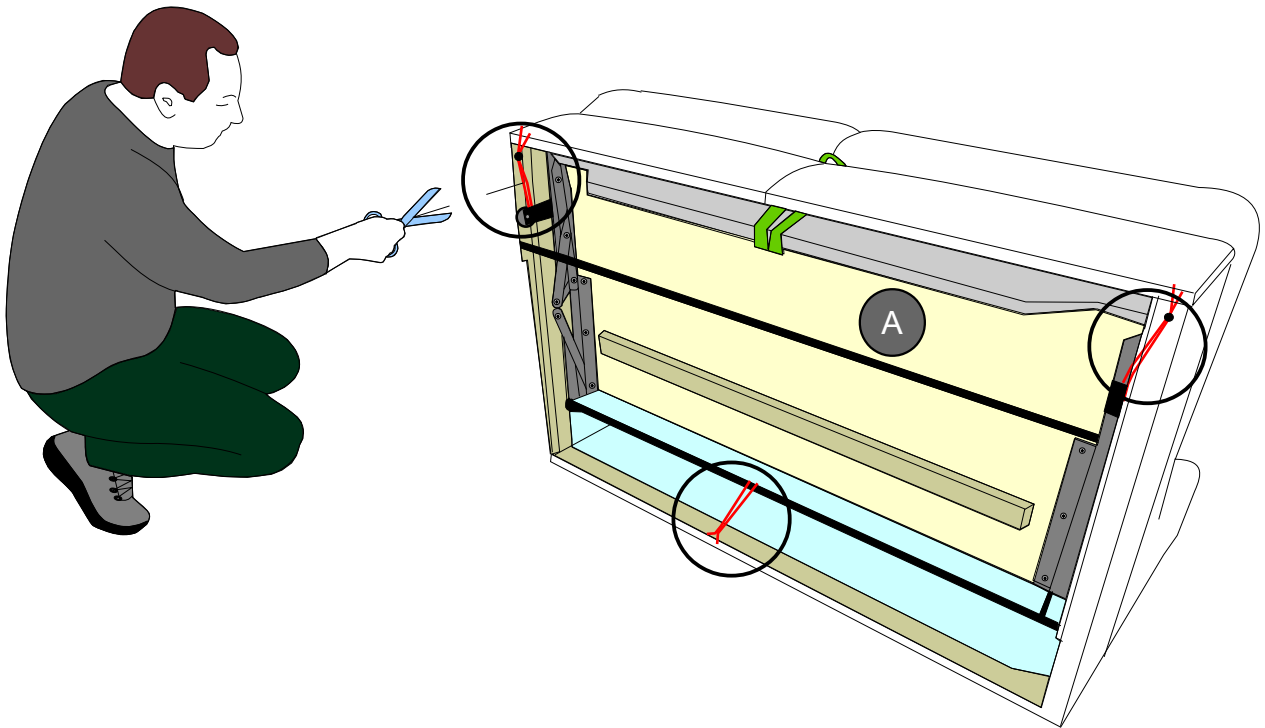
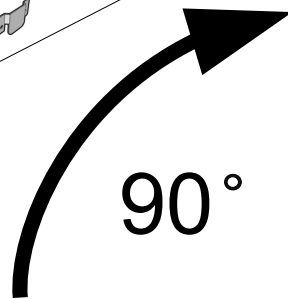
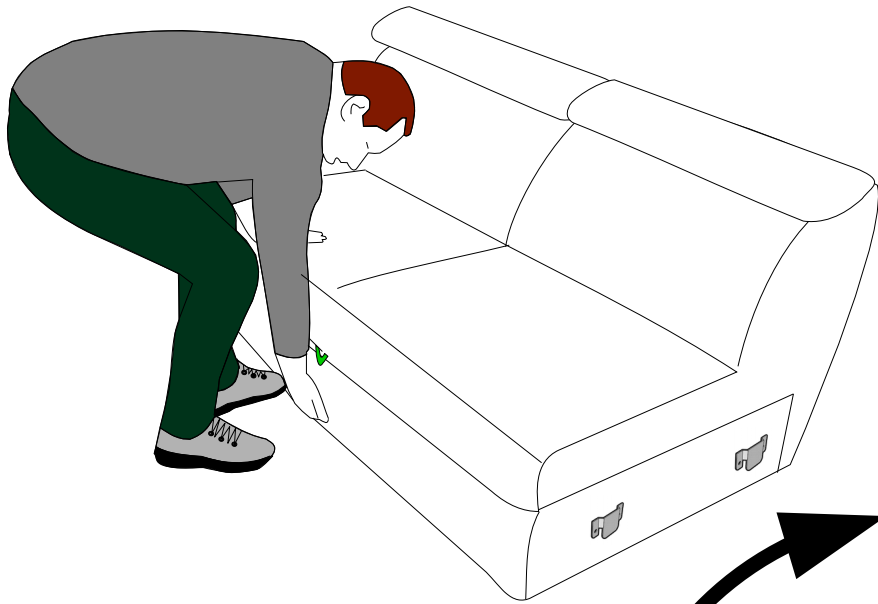

g H-50  X 1	s H-40  X 2	d M5*50  X 3	x Fi-35  X 3	v H-50  X 3	h M5*30  X 12	v₁ Fi-20  10x40 X 6
---	---	--	--	---	---	---



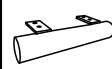

0019

g H-50  X2	z H-50  X2	s H-40  X3	d M5*50  X7	x Fi-35  X7	v H-50  X4	h M5*30  X16	v ₁ Fi-20  10x40 X8
--	--	--	---	---	---	--	--

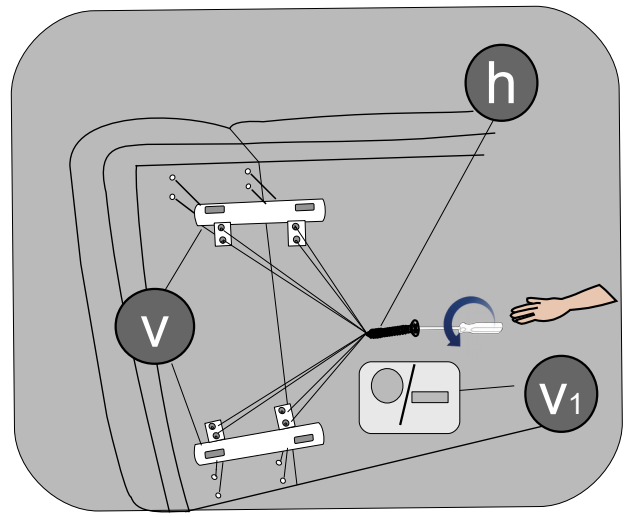
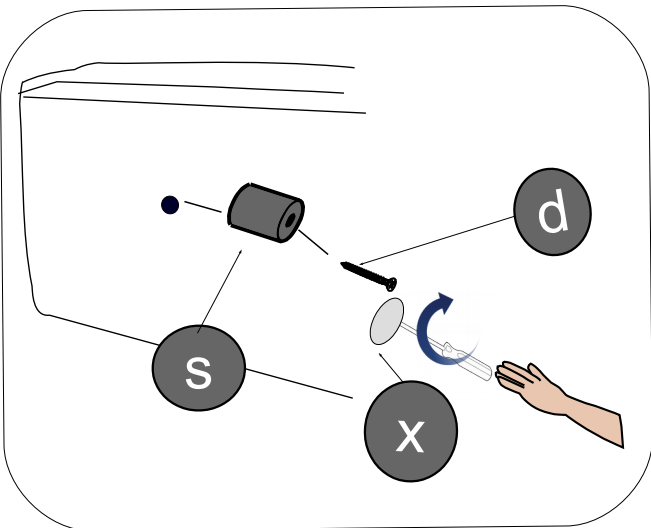
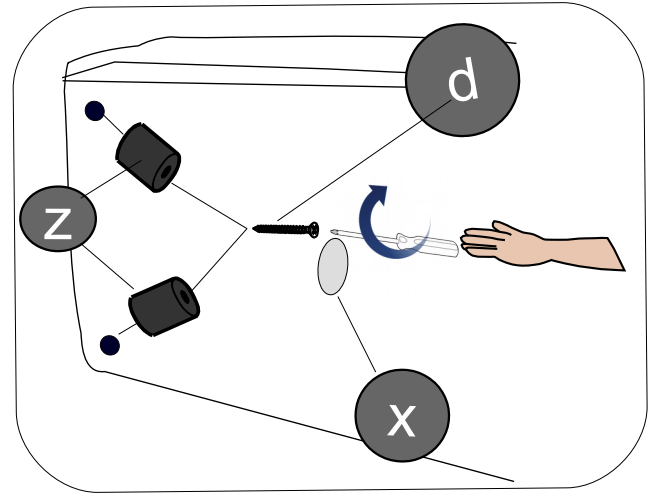
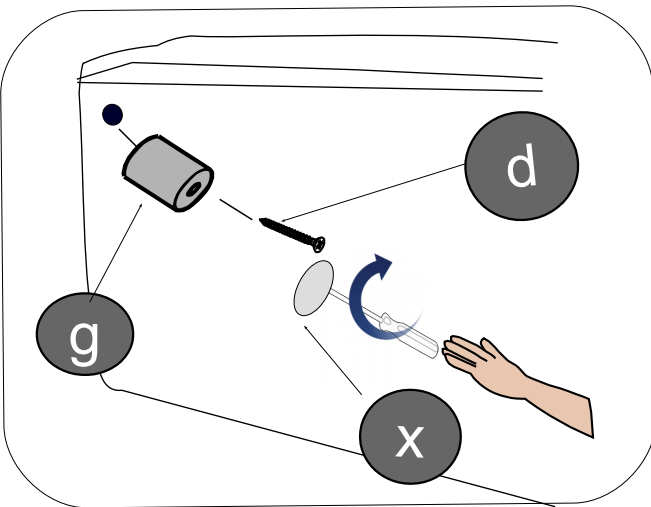
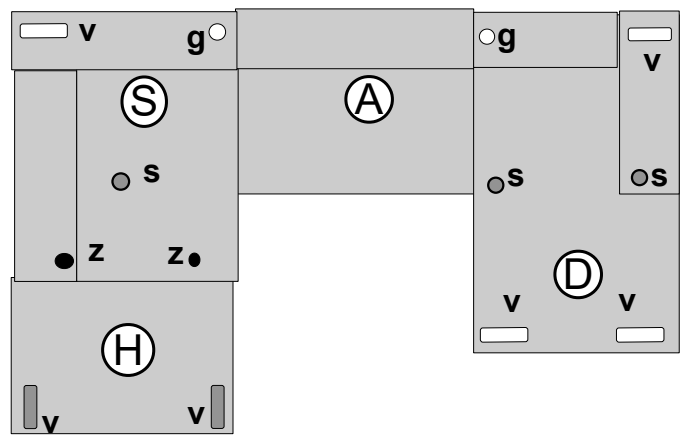
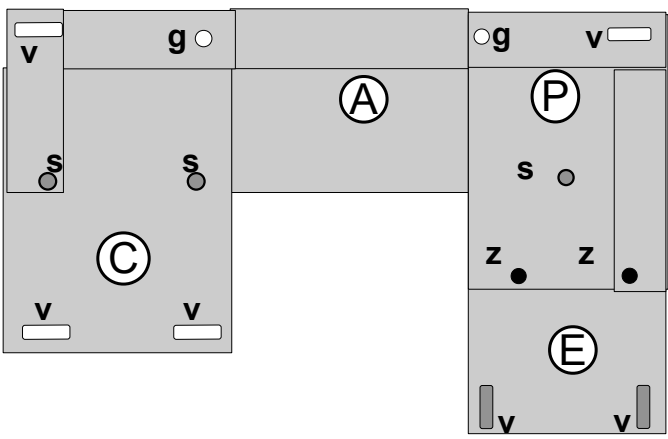
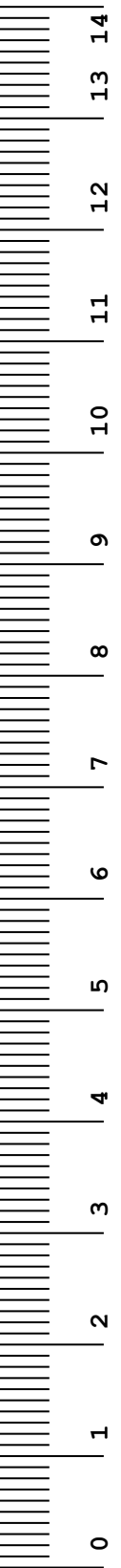
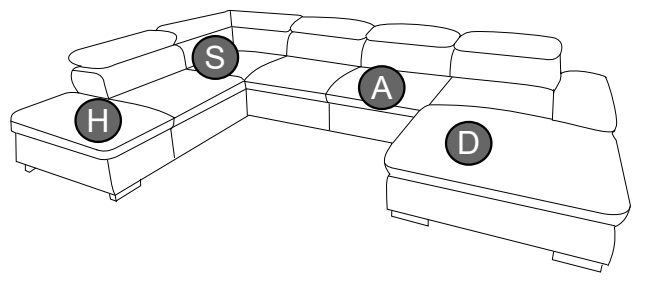
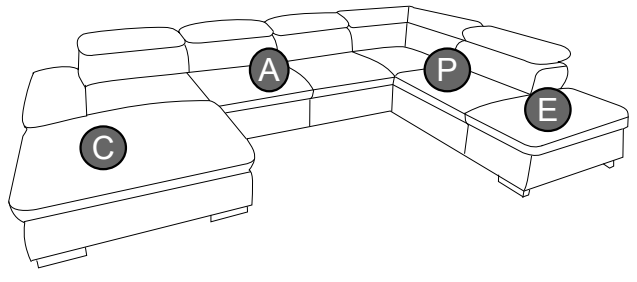

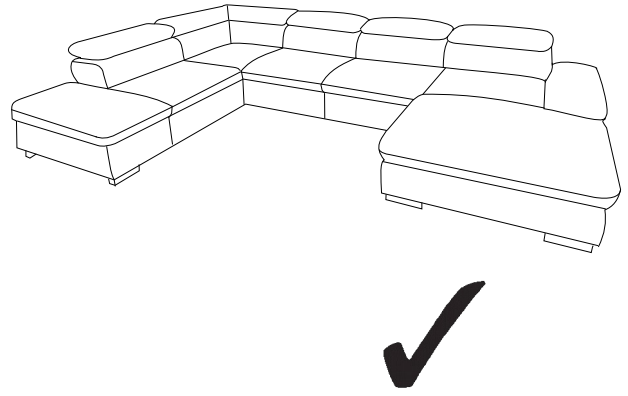
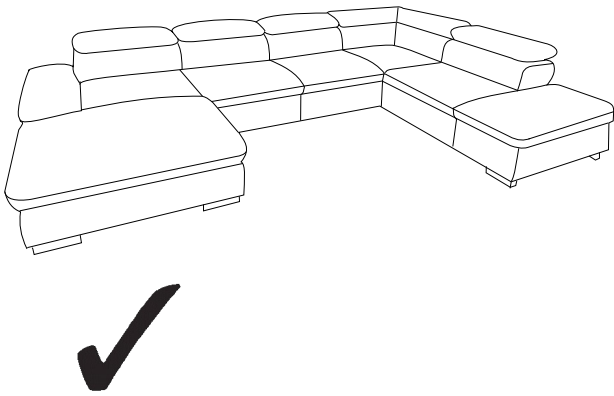
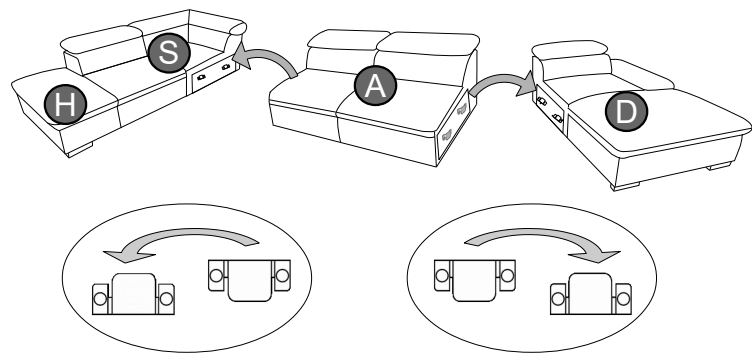
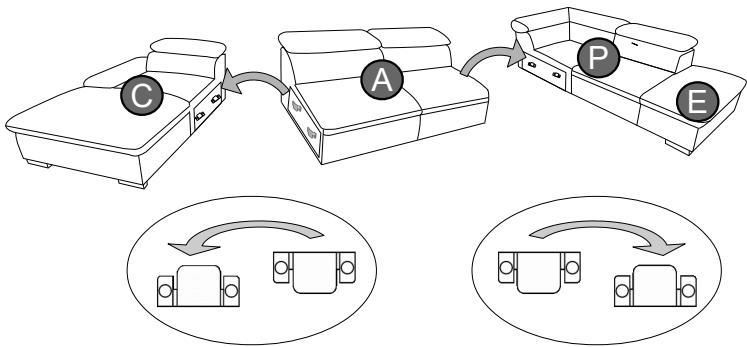
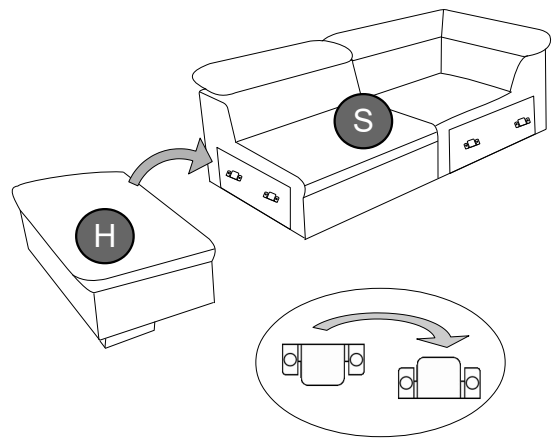
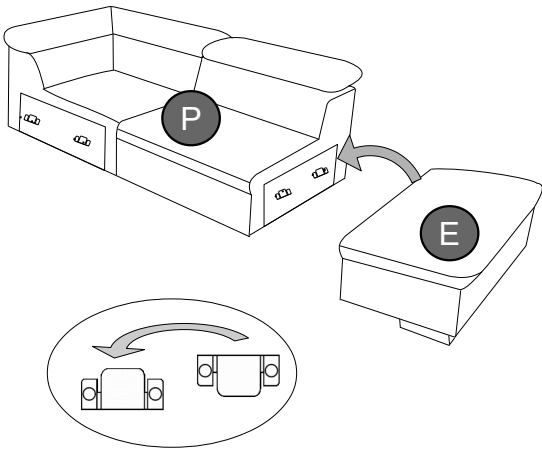

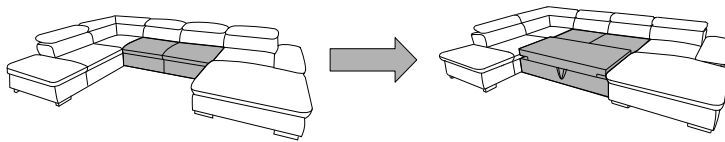

0019

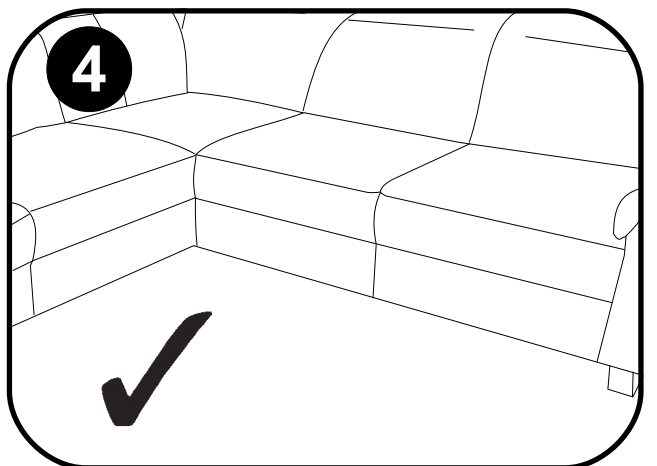
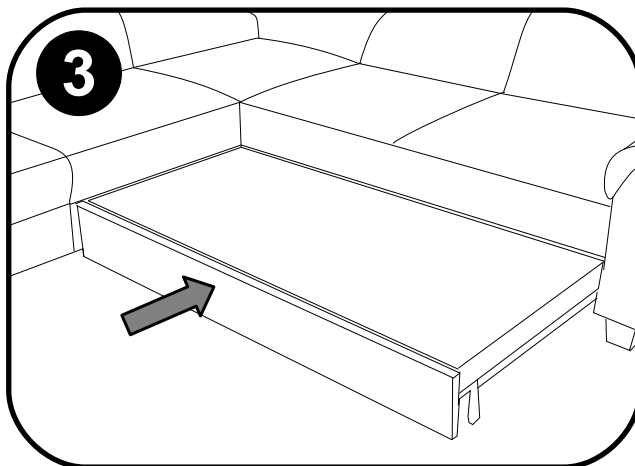
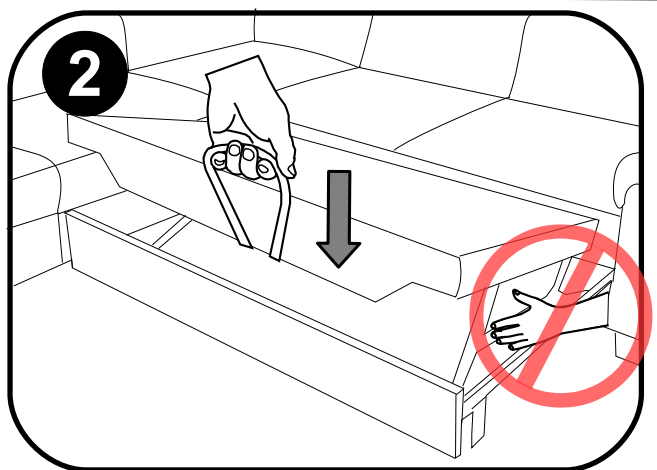
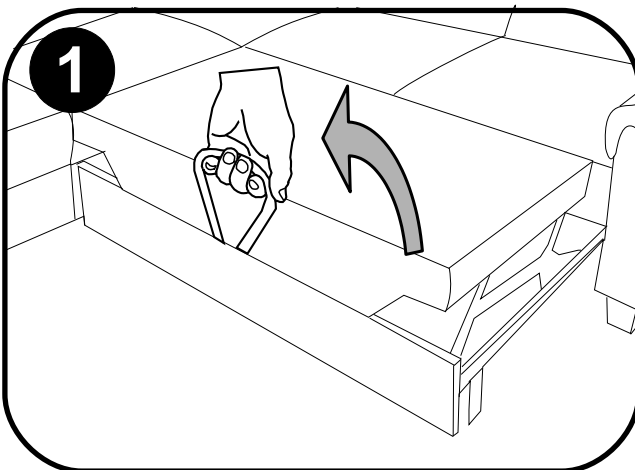
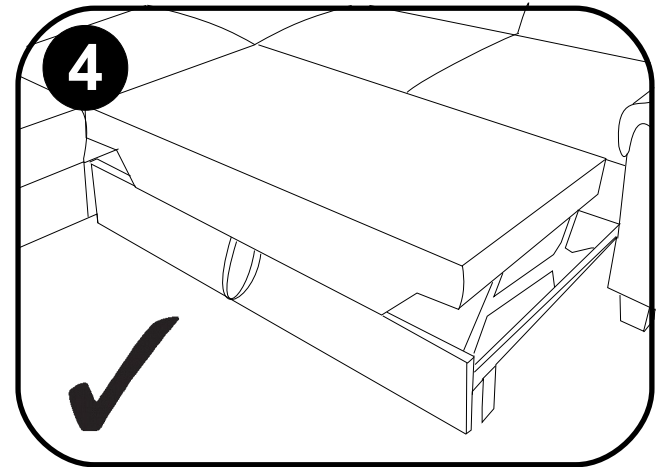
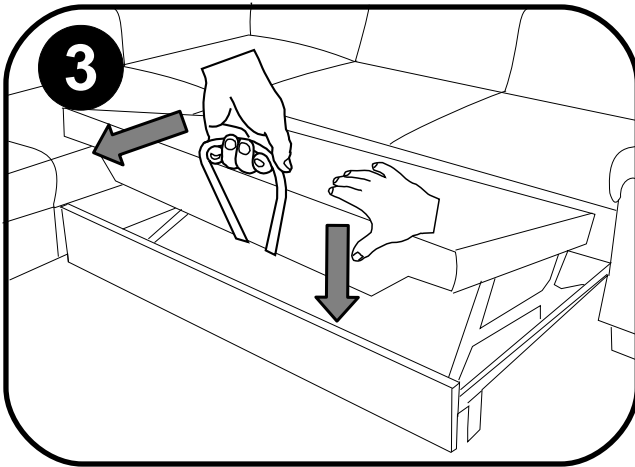
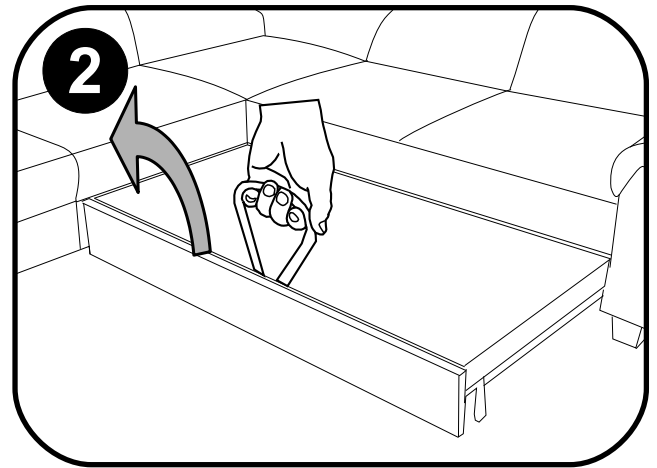
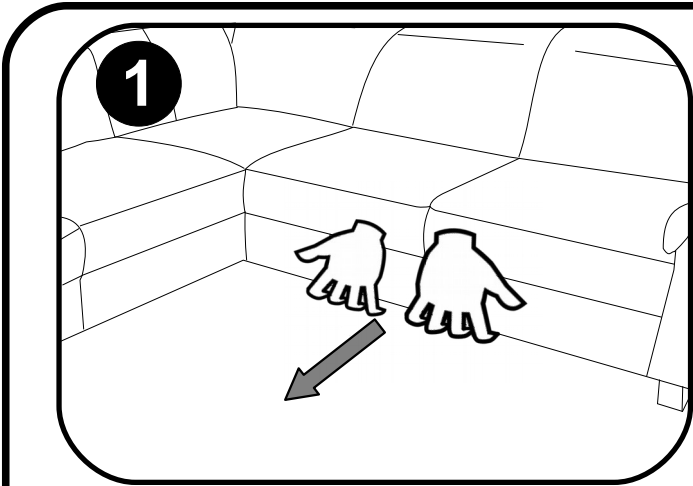

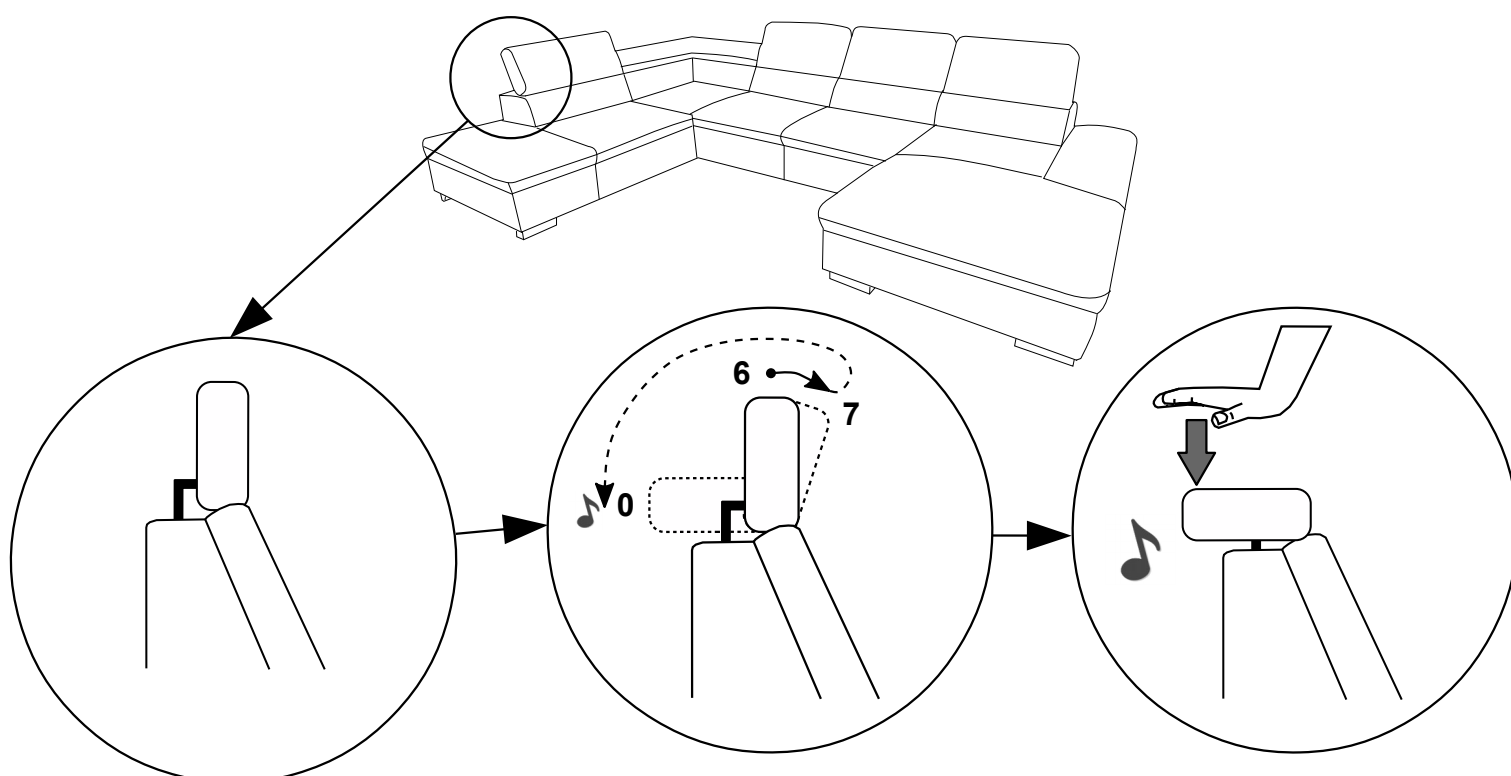
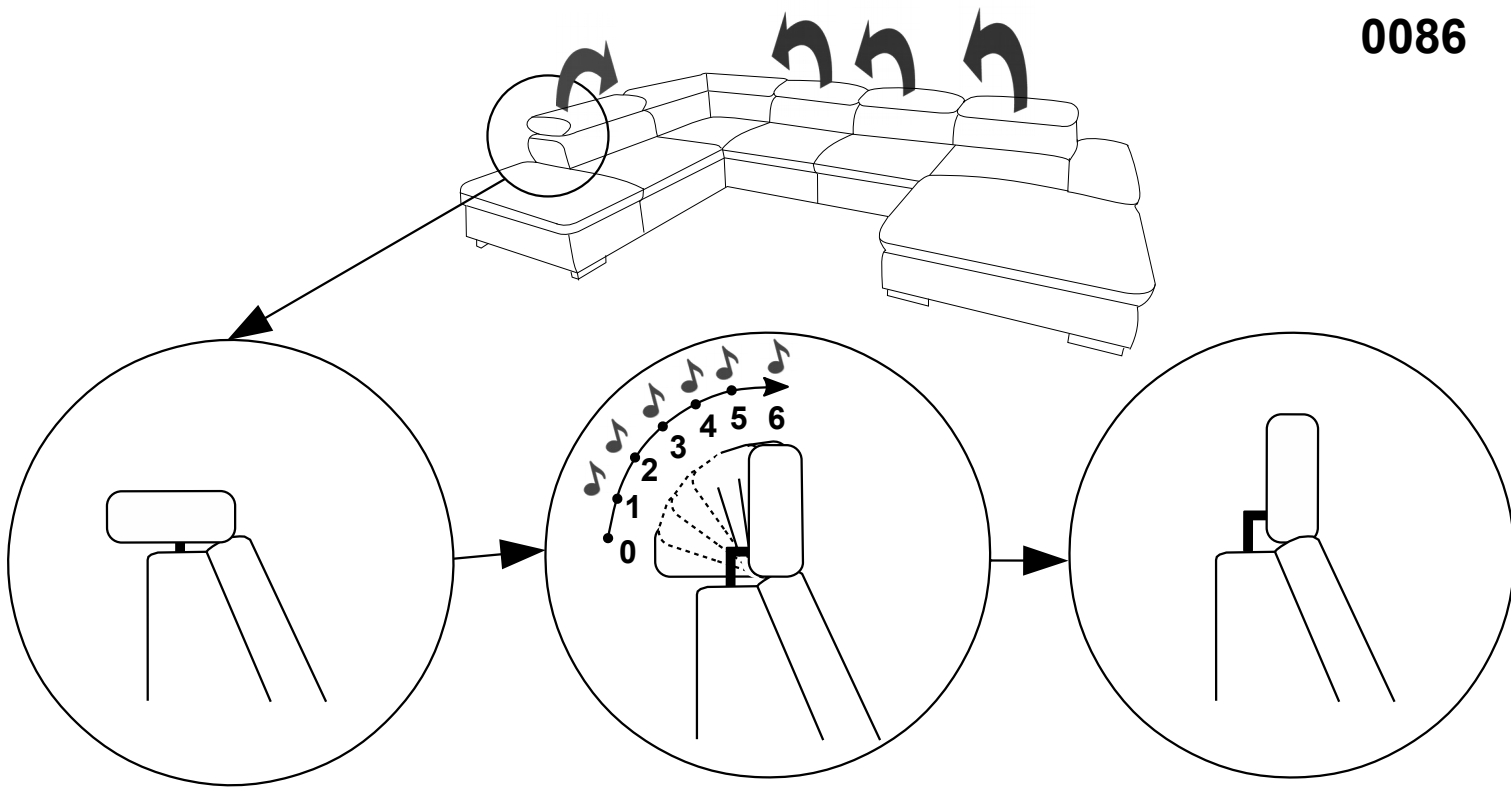

Service · Dienstverlening · Serwis · Servis · Сервисная служба · Serviciu · Services · Servizio
 ·Servisný list · Szolgáltatás · Servisní list

Name · Naam · Nazwa · Ísim · Название · Nume · Nome · Názov · Názov ·
 Název · Neve

VALANTINE, ALCATRAZ, ALCUDIA

Typ · Type · Tip · Тип · Tipo · Típus

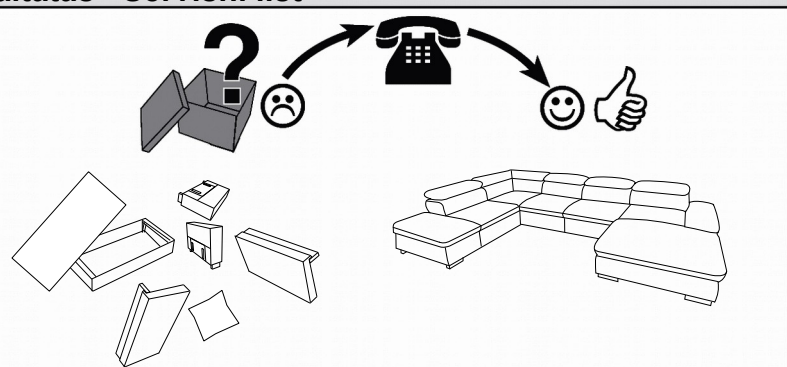

L

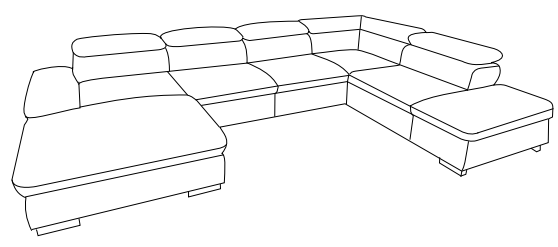

R

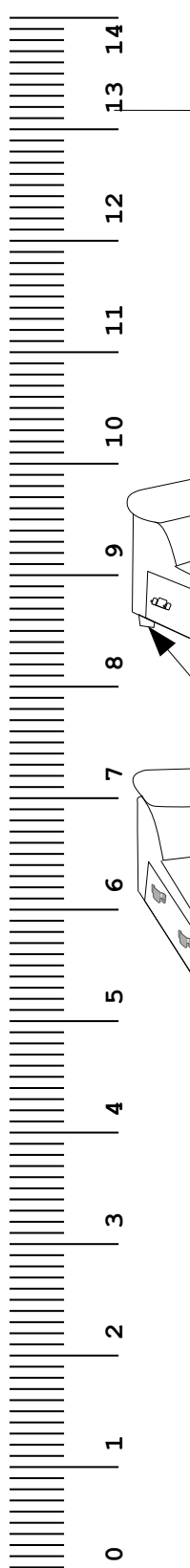
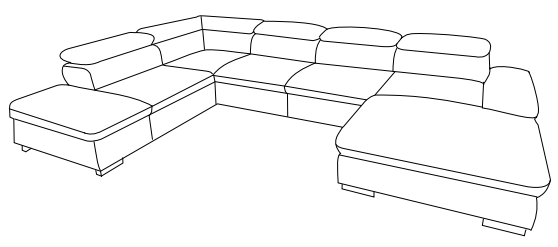

g H-50 	z H-50 	s H-40 	d M5*50 	x Fi- 35 	v H-50 	h M5*30 	Fi- 20 10x40 	[mm]
-------------------	-------------------	-------------------	--------------------	---------------------	-------------------	--------------------	-------------------------	------

