

Art. Nr.

50464701	20171735	18619041	21136328	23703940	45304711	10209337	39921339	23946659
96286437	43007939	89473408	31181747	87161935	86368203	28533310	84176107	55257715
54330210	60614064	85758935	45317826	19767549	32040261	15960966	42191637	27422500
53636701	72779904	11750319	42312417	18266644	69614614	19580462	15404768	32888161
78156322	56028328	72265552	91326527	49176442	87206709	45686022	83823405	12953117
58678351	78603025	38444041	16412244	15705620	81774415	48130414	14010735	76536467
85500722	38630213	66477506	63092250	35105145	93337514	99304717	74653214	10734242
33271363	15403243	29273423	65183940	59352157	87922544	58093117	12941039	40472169

Nele

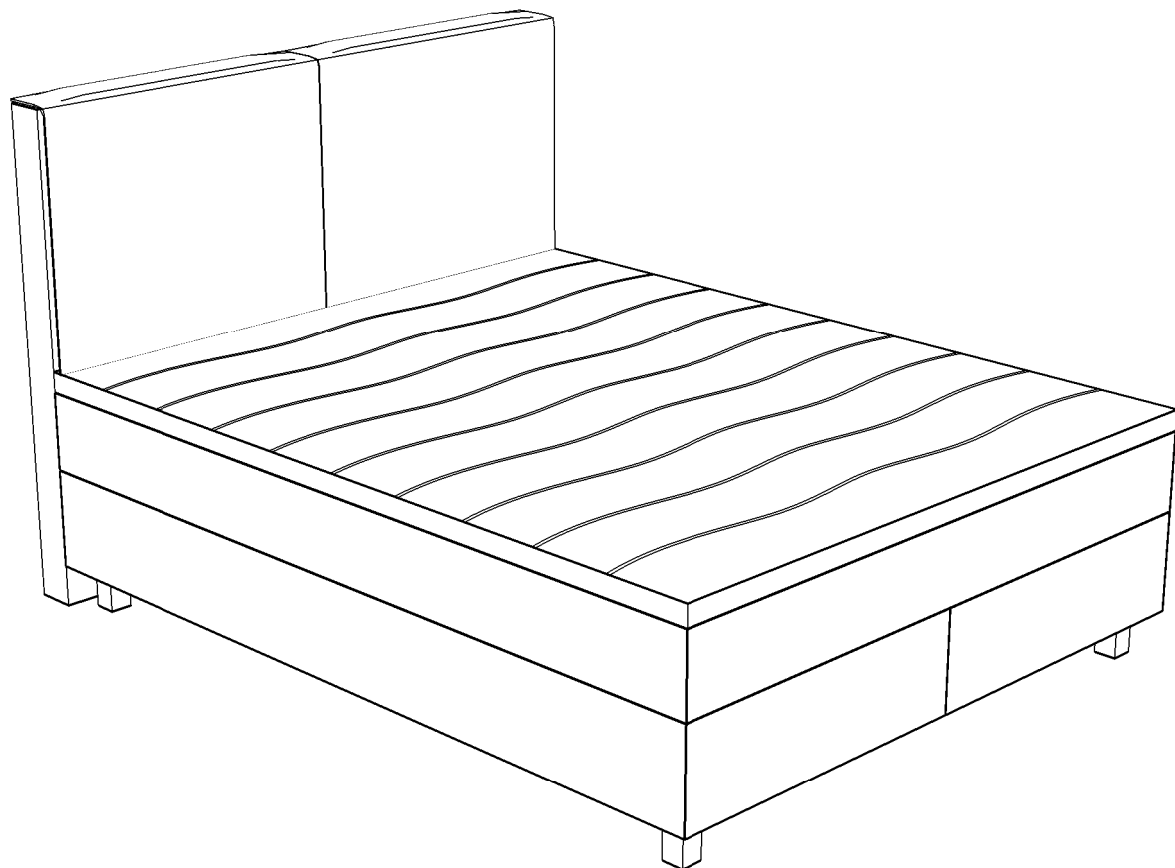

- (D)** Montageanleitung
(FR) Notice de montage
(NL) Handleiding voor de montage
(CZ) Montážní návod
(HU) Szerelési útmutató
(TR) Montaj talimatı
- (GB)** Assembly instructions
(IT) Istruzioni di montaggio
(PL) Instrukcja montażu
(SK) Návod na montáž
(RO) Instrucțiuni de montaj
(RU) Инструкция по монтажу

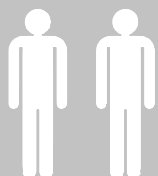

2x120kg- Max

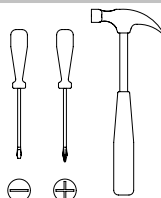

LKZ 41771

Service • Prestation • Servizio • Serwis • Serviciul
 Обслуживание • Szerviz • Servis • Hizmet

Name • Désignation • Nome • Meno Nazwa • Naam • Название • Isim Názov • Név • Jméno • Denumire		Iris	
Nr. • No. • № • Номер • Sz			
50464701	20171735	18619041	21136328 23703940
45304711	10209337	39921339	23946659 96286437
43007939	89473408	31181747	87161935 86368203
28533310	84176107	55257715	54330210 60614064
85758935	45317826	19767549	32040261 15960966
42191637	27422500	53636701	72779904 11750319
42312417	18266644	69614614	19580462 15404768
32888161	78156322	56028328	72265552 91326527
49176442	87206709	45686022	83823405 12953117
58678351	78603025	38444041	16412244 15705620
81774415	48130414	14010735	76536467 85500722
38630213	66477506	63092250	35105145 93337514
99304717	74653214	10734242	33271363 15403243
29273423	65183940	59352157	87922544 58093117
12941039	40472169		

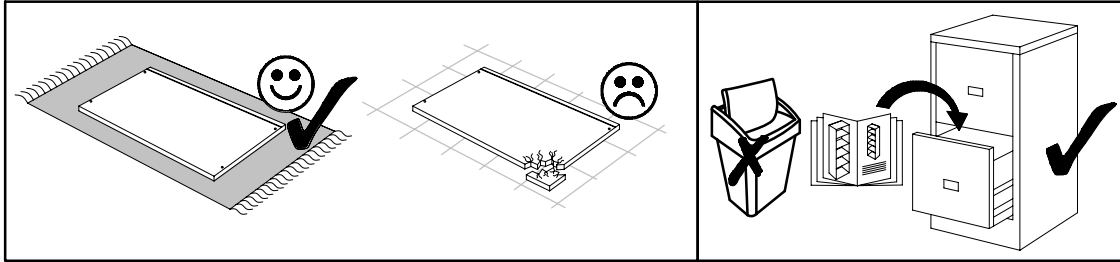
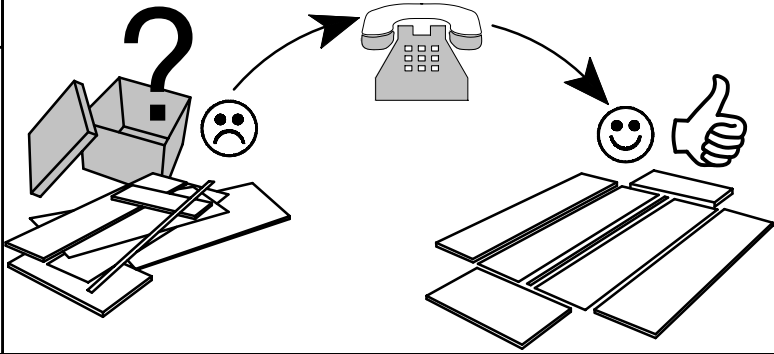

Colli 1

A x1

Colli 2

A x1

Colli 3

C x1

B x1

Colli 4

D x1

E 4x

55x55x100

K 8x

4,5 x35

H 1x

G 8x

D 46

F 4x

45x45x100

1

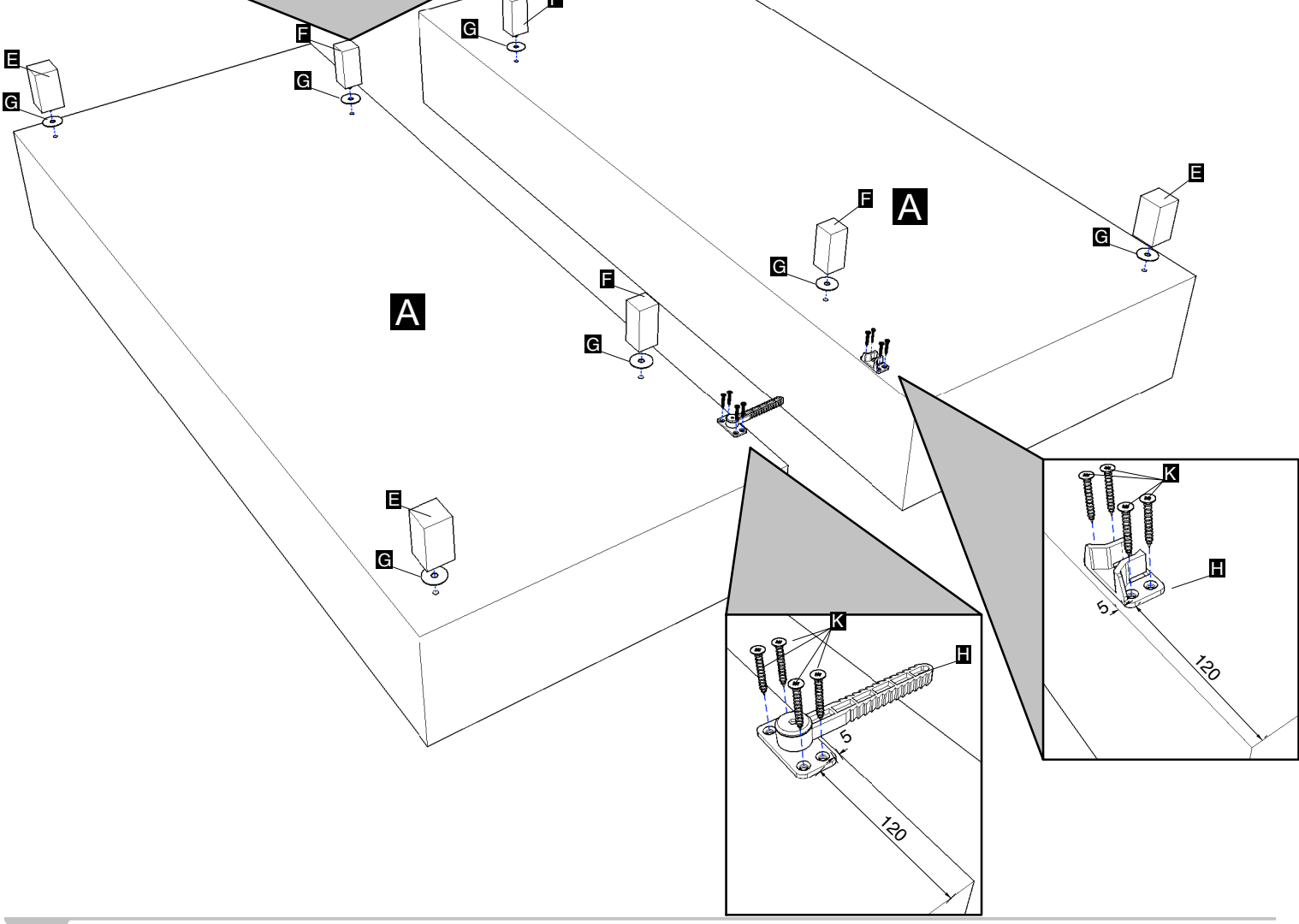
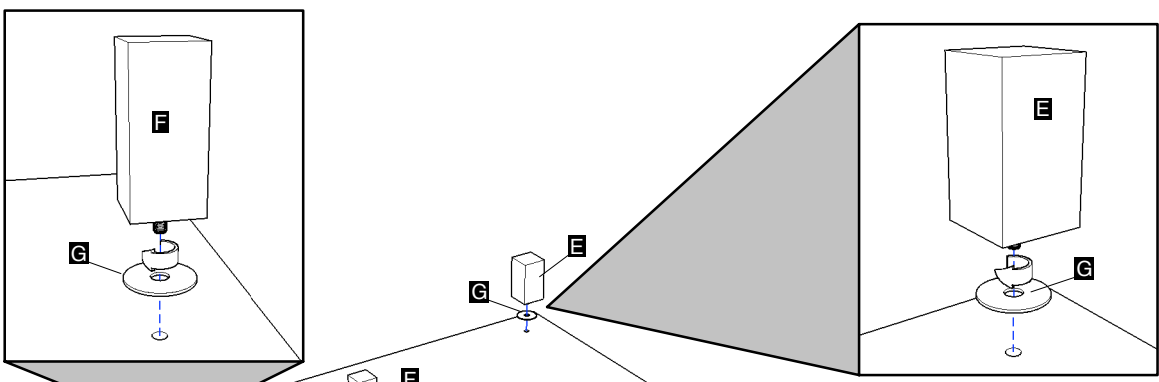
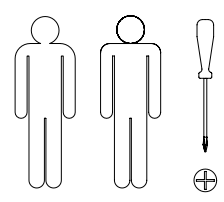

2

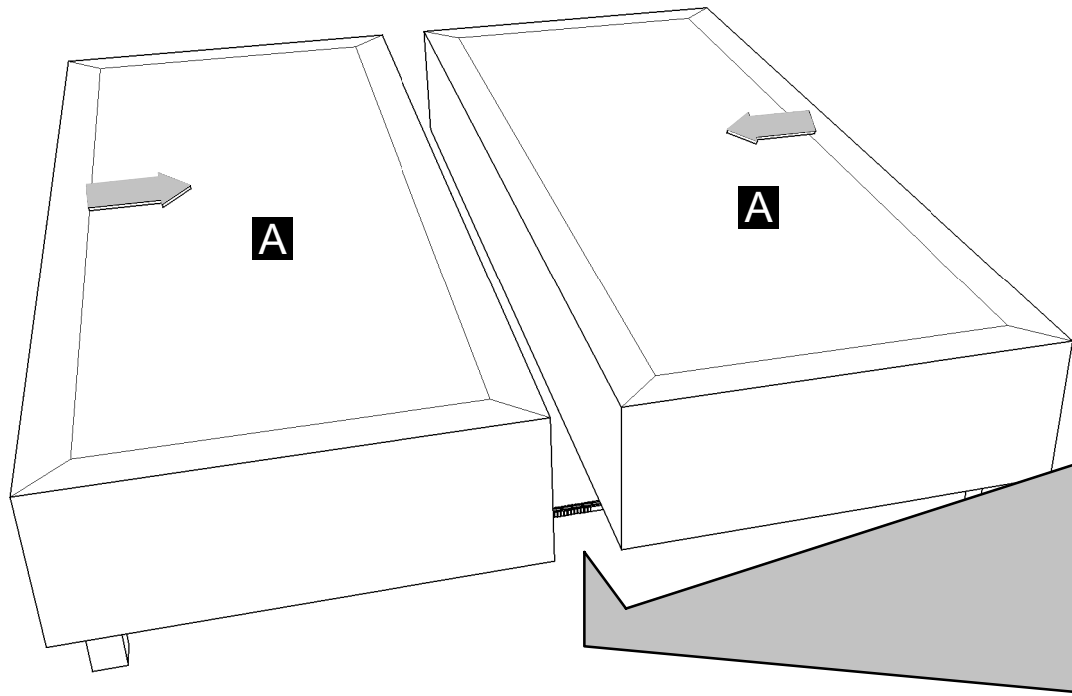
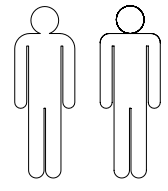

3

3

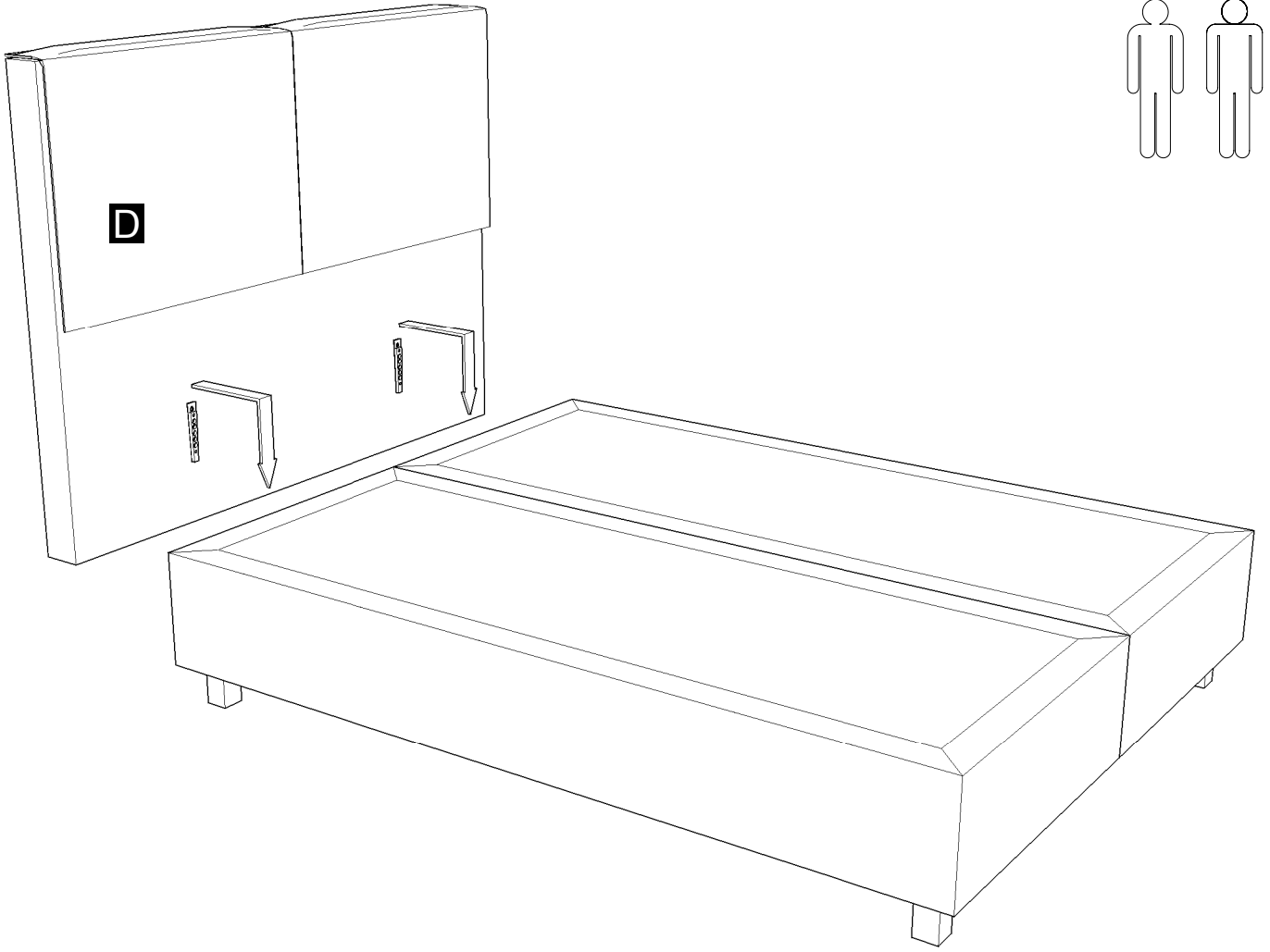

4

